



Final Distribution, Wiring Devices & Smart Home Energy Management Devices

Maximum Retail Price Effective June 10th, 2026



se.com/in

Advancing
Energy Tech

About Schneider Electric	4
Easy9 Philosophy	5
Miniature Circuit Breaker (MCB).....	7
Residual Current Circuit Breaker (RCCB) - AC Type	9
Surge Protection Device.....	10
Timers & Time Switches	11
Easy9 Distribution Boards	13
PratiKa.....	16
Plugs and Sockets - IP44 / IP67	16
Electra	20
Metal Clad Plugs & Sockets	20
56 Series	21
Plugs and Sockets - IP56 / IP66	21
Wiring Devices	24
LIVIA - Switch to the extra-ordinary.....	25
Miluz ZeTa Little things, big impact.....	27
Opale - Switches with Satin Finish	33
Unica Pure - Irresistibly Beautiful	35
ZENcelo India - The Revolutionary Full-Flat Switch	43
AvatarOn - It's also a Switch.....	47
Kavacha - Weather Protected Series.....	54
Metal Boxes	55
Smart Home Energy Management System	56
Wiser™	60
Surface and Flush Mount Occupancy Sensors.....	61
Dimmable Sensors with Light Regulation.....	61
Wall Mount Sensors.....	62
Hotel - ELV Dual Motion Sensor	62

About Schneider Electric

Schneider Electric is a global energy technology leader, driving efficiency and sustainability by electrifying, automating, and digitalizing industries, businesses, and homes. Its technologies enable buildings, data centers, factories, infrastructure, and grids to operate as open, interconnected ecosystems, enhancing performance, resilience, and sustainability. The portfolio includes intelligent devices, software-defined architectures, AI-powered systems, digital services, and expert advisory. With 160,000 employees and 1 million partners in over 100 countries, Schneider Electric is consistently ranked among the world's most sustainable companies. 60 years of history in India with a strong foot-print in manufacturing, innovation, and customer connect. India is the 3rd largest market for Schneider Electric Group.

Our business offerings

Span the entire spectrum from Plant-to-Plug.

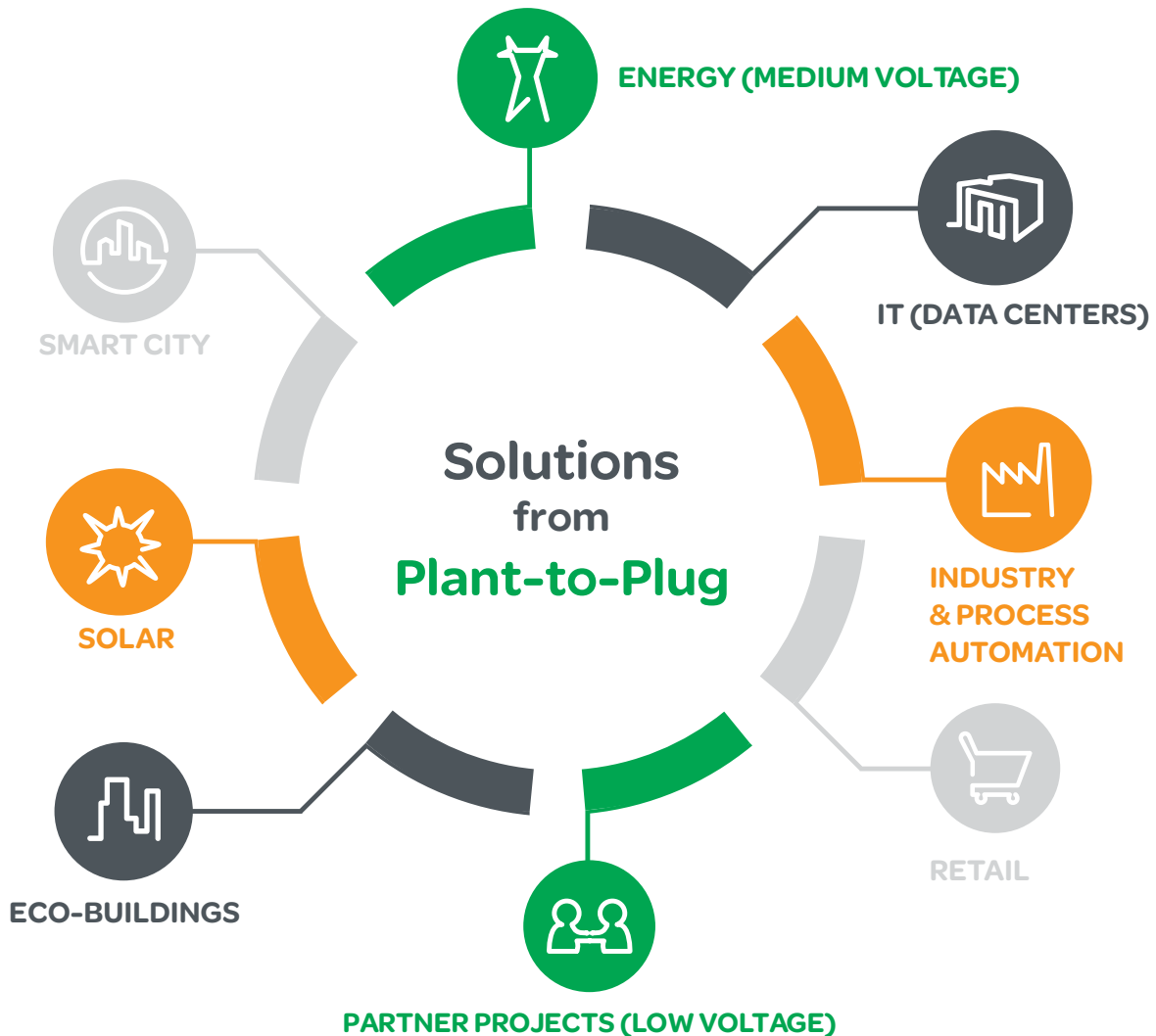

Easy9 Philosophy

Easy on eyes



Easy on mind



Easy to sell

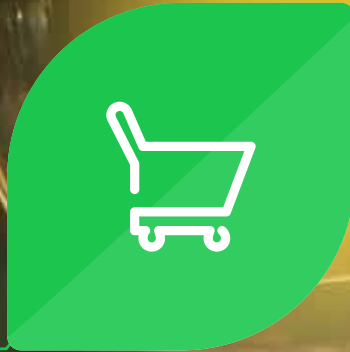

Easy to install



Safeguard your peace of mind

Get maximum electrical protection with Easy9



Miniature Circuit Breaker (MCB)

For circuit protection against Overload and Short Circuit Current Fault

- Conforms to IS/IEC 60898-1
- Breaking Capacity 6kA, 10kA
- Green Compliance: RoHS, REACH
- Energy Limiting Class 3
- Trip Free Mechanism

- Fast Tripping Mechanism
- Suitable for Positive Isolation
- Line Load Reversibility
- Bi-connect Terminals

- Degree of Protection IP 20
- Operating Voltage 240V / 415V
- Frequency 50Hz



Easy9 - C Curve 6kA

[In] Rated Current (A)	1 Pole Reference	Unit MRP [₹]	2 Pole Reference	Unit MRP [₹]	3 Pole Reference	Unit MRP [₹]	4 Pole Reference	Unit MRP [₹]
Module Width**	1 mod		2 mod		3 mod		4 mod	
Package Size	12 Nos.		6 Nos.		4 Nos.		3 Nos.	
6	EZ9F76106	308	EZ9F76206	1211	EZ9F76306	1882	-	-
10	EZ9F76110	308	EZ9F76210	1211	EZ9F76310	1882	-	-
16	EZ9F76116	308	EZ9F76216	1211	EZ9F76316	1882	EZ9F76416	2675
20	EZ9F76120	308	EZ9F76220	1211	EZ9F76320	1882	EZ9F76420	2675
25	EZ9F76125	308	EZ9F76225	1211	EZ9F76325	1882	EZ9F76425	2675
32	EZ9F76132	308	EZ9F76232	1211	EZ9F76332	1882	EZ9F76432	2675
40	EZ9F76140	706	EZ9F76240	1610	EZ9F76340	2723	EZ9F76440	3646

Easy9 - C Curve 10kA

[In] Rated Current (A)	1 Pole Reference	Unit MRP [₹]	2 Pole Reference	Unit MRP [₹]	3 Pole Reference	Unit MRP [₹]	4 Pole Reference	Unit MRP [₹]
Module Width**	1 mod		2 mod		3 mod		4 mod	
Package Size	12 Nos.		6 Nos.		4 Nos.		3 Nos.	
6	EZ9F71106	411	-	-	EZ9F71306	2386	-	-
10	EZ9F71110	411	EZ9F71210	1498	EZ9F71310	2386	-	-
16	EZ9F71116	411	EZ9F71216	1498	EZ9F71316	2386	EZ9F71416	3240
20	EZ9F71120	411	EZ9F71220	1498	EZ9F71320	2386	EZ9F71420	3240
25	EZ9F71125	411	EZ9F71225	1498	EZ9F71325	2386	EZ9F71425	3240
32	EZ9F71132	411	EZ9F71232	1498	EZ9F71332	2386	EZ9F71432	3240
40	-	-	EZ9F71240	2202	EZ9F71340	3421	EZ9F71440	4177
63	EZ9F71163	1078	EZ9F71263	2468	EZ9F71363	3664	EZ9F71463	4414

Easy9 - B Curve 10kA

[In] Rated Current (A)	1 Pole Reference	Unit MRP [₹]	2 Pole Reference	Unit MRP [₹]
Module Width**	1 mod		2 mod	
Package Size	12 Nos.		6 Nos.	
6	EZ9F21106	377	-	-
10	EZ9F21110	377	-	-
16	EZ9F21116	377	-	-
20	EZ9F21120	377	-	-
25	EZ9F21125	377	-	-
32	EZ9F21132	377	EZ9F21232	2044
40	-	-	EZ9F21240	2153

Note:

Please contact nearest Schneider Electric Sales Office or Customer Care Center for Stockable and Non Stockable status of references

*Price on Request

**18mm/module

*Bold references are MTO reference.

Shield your devices and your loved ones too

Get maximum electrical protection
with **Easy9**



Residual Current Circuit Breaker (RCCB) - AC Type

For protection against Risk of Shock / Electrocution and Risk of Fire in case of Earth Leakage Current

- CE Marked Conforms to IS 12640-1, IEC 61008-1
- Green Compliance: RoHS, REACH
- Operating voltage 240 / 415V
- Operating Frequency 50Hz



[In] Rated Current (A)	Earth Leakage Sensitivity (mA)	2 Pole Reference	Unit MRP [₹]	4 Pole Reference	Unit MRP [₹]
Module Width**		2 Mod		4 Mod	
Package Size		6 Nos.		3 Nos.	
25	30	EZ9R35225	5096	EZ9R35425	6906
	100	EZ9R55225	5413	EZ9R55425	7033
	300	EZ9R65225	5515	EZ9R65425	7169
40	30	EZ9R35240	5288	EZ9R35440	6788
	100	EZ9R55240	5666	EZ9R55440	7169
	300	EZ9R65240	5619	EZ9R65440	7176
63	30	EZ9R35263	7078	EZ9R35463	7141
	100	EZ9R55263	7430	EZ9R55463	7646
	300	EZ9R65263	7351	EZ9R65463	7580

Note:

Please contact nearest Schneider Electric Sales Office or Customer Care Center for Stockable and Non Stockable status of references

*Price on Request

**18mm/module

Isolator

- CE Marked Conforms to IEC 60947-3
- For isolation of electrical circuits for maintenance or repair by ensuring there is no residual voltage or current present in the isolated section
- Utilisation category - AC 22
- Green Compliance: RoHS, REACH
- Suitable for Positive Isolation
- Line Load Reversibility
- Laser Printing
- Bi-connect Terminals
- Degree of Protection IP 20
- Operating Voltage 240V / 415V
- Frequency 50Hz



[In] Rated Current (A)	2 Pole Reference	Unit MRP [₹]	3 Pole Reference	Unit MRP [₹]	4 Pole Reference	Unit MRP [₹]
Module Width**		2 Mod		3 Mod		4 Mod
Package Size		6 Nos.		4 Nos.	3 Nos.	
40	EZ9S66240	816	EZ9S66340	1735	EZ9S66440	1950
63	EZ9S66263	1088	EZ9S66363	1943	EZ9S66463	1986
80	-	-	-	-	EZ9S66480	2542

Note:

Please contact nearest Schneider Electric Sales Office or Customer Care Center for Stockable and Non Stockable status of references

*Price on Request

**18mm/module

*Bold references are MTO reference.

Surge Protection Device

For Protection of Devices against Lightning & Switching Surges

- Conforms to IEC 61643 - 11
- In conformance with standards IEC 61643-11
- For protection against Indirect lightning and Switching surges
- Inbuilt health Indicator
- Always use a Back-up MCB with your SPD



Surge Arresters - Type 2

[Imax] Rated Current (kA)	1P+ N Reference	Unit MRP [₹]	3P+N Reference	Unit MRP [₹]
Module Width**	2 Mod		4 Mod	
Package Size	6 Nos.		3 Nos.	
20kA	EZ9L33620	4679	EZ9L33720	7916
45kA	-	-	EZ9L33745	11876

Network: single phase
Earthing system: TT or TN-S

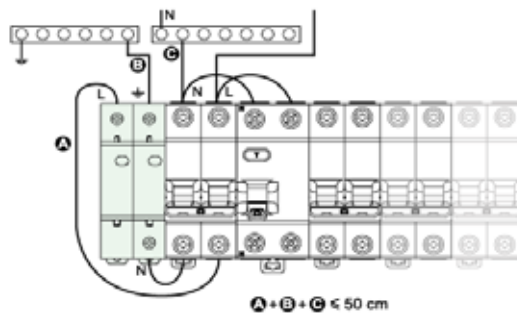

Network: three phase
Earthing system: TT or TN-S

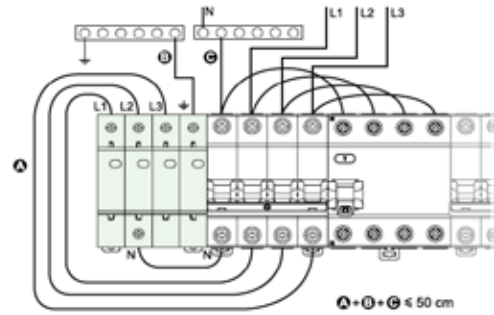

Backup MCB Selection Chart

[Imax] Rated Current (kA)	1P+ N Reference	Backup MCB	3P+N Reference	Backup MCB
20kA	EZ9L33620	EZ9F71220	EZ9L33720	EZ9F71420
45kA	-	-	EZ9L33745	EZ9F71463

Note:

Please contact nearest Schneider Electric Sales Office or Customer Care Center for Stockable and Non Stockable status of references

*Price on Request

**18mm/module

*Bold references are MTO reference.

Timers & Time Switches

Analog Time Switches



- 24H, 7D Programmable switch Voltage Rating: 230V AC +10%, -15%
- Memory: Upto 56 Switching Operations
- Back up of program: Operating reserve for 100, 200 Hours
- Overall dimensions: 5 modules
- Minimum time between two switching operations: 15, 30 min
- Accuracy: $\leq \pm 1$ s/day at +20°C

Description	Module Width 18mm/module	Reference	Unit MRP [₹]
IH 24H 16 A 15 mts interval 1 channel	1	15336	7187
IH 24H 16 A 30 mts interval 1 channel	1	CCT15365	7839
IH 7 day 16 A 1 channel- Max 21 On and 21 Off cycles	3	CCT15367	11222
IH 24H 16 A 30 mts 1 channel without reserve	3	CCT16364	6367

Digital Time Switches



- 7D, 24H Programmable switch. Voltage Rating: 230V AC +10%, -15%
- Consumption: 1 channel - max. 4VA; 2 channels - max. 7VA
- Memory: Upto 56 Switching Operations
- Back up of program & time by lithium battery: Operating reserve: 6 Years
- Overall dimensions: 5 modules
- Cable length: 100m
- Minimum time between two switching operations: 1 min

Description	Module Width 18mm/module	Reference	Unit MRP [₹]
IHP 1C w (24h/7d) programmable time switch	2.5	CCT15441	15448
IHP+ 1C (24h/7d) SMARTw programmable time switch	2.5	CCT15551	19056
IHP 2C w (24h/7d) programmable time switch	2.5	CCT15443	19927
IHP DCF (24h/7d) SMART programmable time switch	2.5	CCT15858	31369
IHP+ 2C (24h/7d) SMARTw programmable time switch	2.5	CCT15553	22046

Timers



- Switching capacity 16 A, max
- Delay range from 30 sec to 20 min
- Capacity for lighted pushbutton 150 mA
- Electric distribution busbar compatibility
- Output power capacity CCT15232-2300W
- Output power capacity CCT15223-3600W

Description	Module Width 18mm/module	Reference	Unit MRP [₹]
MINs - electronic timer - 0.5 to 20 min	1	CCT15232	8727
MINs - electronic timer - 0.5 to 20 min with switch Off Warning	1	CCT15233	11205
MINs - electronic timer - 0.5 to 20 min with switch Off Warning and Impulse relay function	1	CCT15234	10533

Note:

Please contact nearest Schneider Electric Sales Office or Customer Care Center for Stockable and Non Stockable status of references

*Price on Request

**18mm/module

*Bold references are MTO reference.

Timers & Time Switches

Twilight switch



- Includes wall mounted cell
- Adjustable brightness threshold 2 to 2000 Lux
- 2 LEDs to signal the sensor status and the output status
- Test button: To check the product and load cabling
- Switching capacity: 16Amp
- Screwless Terminals compatible with rigid and flexible wires
- Consumption 6 VA
- Size 45mm

Description	Module Width 18mm/module	Reference	Unit MRP [₹]
IC2000 outdoor (2 - 2000 lux) twilight switch	1	CCT15369	18403
Analogue indoor light sensor cell	-	CCT15262	9081
Wall mounted Analogue outdoor light sensor cell	-	CCT15263	14076
IC100 (2 - 100 lux) twilight switch	1	CCT15482	15481
IC2000 indoor (2 - 2000 lux) twilight switch	1	CCT15285	13797
IC2000p+ (2 - 2000 lux) programmable twilight switch	2.5	CCT15483	31978
IC100kp+ 1C (1 - 99000 lux) SMART programmable twilight switch	2.5	CCT15494	38676
IC100kp+ 2C (1 - 99000 lux) SMART programmable twilight switch	2.5	CCT15495	47613
IC Astro 2C SMART programmable twilight switch	2.5	CCT15245	33426
IC Astro 1C SMART programmable twilight switch	2.5	CCT15225	28126

Time switch accessories

Description	Module Width 18mm/module	Reference	Unit MRP [₹]
Programming kit for IHP / IC	1	CCT15860	14713

Thermostat

Description	Module Width 18mm/module	Reference	Unit MRP [₹]
THP1+ 1C (24h/7d) programmable thermostat	2.5	CCT15834	33468

Note:

Please contact nearest Schneider Electric Sales Office or Customer Care Center for Stockable and Non Stockable status of references

*Price on Request

**18mm/module

*Bold references are MTO reference.

Easy9 Distribution Boards



IK-08
tested

IP-30
Single door
IP-43
Double door



Features

- Clean and attractive colour and finish (White RAL 9003)
- Unique design of door knob for easy operation
- Conforms to IS 8623
- High quality powder coating for long life and high reliability under the toughest of conditions
- Optimized wiring space for a clean installation
- Suitable for surface and flush mounting
- Cement Spill protector helps avoid entry of dust and cement particles
- Reversible door
- Independent centre plate
- 45° angled hole for easy installation and 1 key hole for easy alignment
- Removable top and bottom gland plates
- Unique 5-hole mounting for single-person fixing
- Conforming to international standards: Tested as per IEC 61439-3 at NABL accredited laboratories and IP tested at CPRI
- Combi-head screws for tool flexibility

Easy9 Distribution Boards

Metal Enclosures



Description	Module Cutout Width**	Single Door (IP30) Reference	Unit MRP [₹]
2 way Enclosure	2	EZ9EMES02	810
4 way Enclosure	4	EZ9EMES04	914

Metal Clad P&S Units



Description	Module Cutout Width**	Single Door (IP30) Reference	Unit MRP [₹]
EZ9 Metal P&S Unit 20A 1P+N+E	2	EZ9EMS220	2624
EZ9 Metal P&S Unit 30A 3P+E	3	EZ9EMS330	6008

Phase Selector DBs



Description	Module Cutout Width**	Double Door (IP43) Reference	Unit MRP [₹]
Easy9 DB 4Way phase selector vertical	8 + 4 x 3	EZ9EPVD04N	10588
Easy9 DB 6Way phase selector vertical	8 + 6 x 3	EZ9EPVD06N	11278
Easy9 DB 8Way phase selector vertical	8 + 8 x 3	EZ9EPVD08N	12176

Phase Selector Switch



Description	Reference	Unit MRP [₹]
Easy9 DB 40A selector switch	EZ9EPS40SN	9638
Easy9 DB 63A selector switch	EZ9EPS63SN	11278

SPN DBs



Description	Total Module Cutout Width** (Incomer + Outgoing)**	Single Door (IP30) Reference	Unit MRP [₹]	Double Door Metal (IP43) Reference	Unit MRP [₹]
Easy9 SPN DB 4 way	2 + 2	-	-	EZ9ESND04	2616
Easy9 SPN DB 6 way	2 + 4	-	-	EZ9ESND06	2712
Easy9 SPN DB 8 way	2 + 6	EZ9ESNS08	1943	EZ9ESND08	2973
Easy9 SPN DB 10 way	2 + 8	-	-	EZ9ESND10	3226
Easy9 SPN DB 12 way	2 + 10	-	-	EZ9ESND12	3545
Easy9 SPN DB 16 way	2 + 14	-	-	EZ9ESND16	5224

Note:

Please contact nearest Schneider Electric Sales Office or Customer Care Center for Stockable and Non Stockable status of references
*Bold references are MTO reference.

Easy9 Distribution Boards

TPN DBs



Description	Total Module Cutout Width** (Incomer + Outgoing)	Double DoorMetal (IP43) Reference	Unit MRP [₹]
Easy9 TPN DB 4 way - 4 Mod Incomer	4 + 4 x 3	EZ9ETND04E	5262
Easy9 TPN DB 4 way	8 + 4 x 3	EZ9ETND04	6074
Easy9 TPN DB 6 way	8 + 6 x 3	EZ9ETND06	7567
Easy9 TPN DB 8 way	8 + 8 x 3	EZ9ETND08	9554
Easy9 TPN DB 12 way	8 + 12 x 3	EZ9ETND12	14630

VTPN DBs Modular Incomer



Description	Total Module Cutout Width** (Incomer + Outgoing)	Double DoorMetal (IP43) Reference	Unit MRP [₹]
Easy9 VTPN DB 4 Ways Modular i/c	12+12	EZ9EVM04	11195
Easy9 VTPN DB 8 Ways Modular i/c	12+24	EZ9EVM08	16107
Easy9 VTPN DB 12 Ways Modular i/c	12+36	EZ9EVM12	20277

VTPN DBs MCCB Incomer



Description	Total Module Cutout Width** (Incomer + Outgoing)	Double DoorMetal (IP43) Reference	Unit MRP [₹]
Easy9 VTPN DB 4 Ways CVS i-c 100A	100A MCCB+ 12	EZ9EVN04L	14022
Easy9 VTPN DB 8 Ways CVS i-c 100A	100A MCCB+ 24	EZ9EVN08L	18346
Easy9 VTPN DB 12 Ways CVS i-c 100A	100A MCCB+ 36	EZ9EVN12L	22644
Easy9 VTPN DB 4 Ways CVS i/c 160A	160A MCCB+ 12	EZ9EVN04M	15429
Easy9 VTPN DB 8 Ways CVS i/c 160A	160A MCCB+ 24	EZ9EVN08M	20598
Easy9 VTPN DB 12 Ways CVS i/c 160A	160A MCCB+ 36	EZ9EVN12M	25727
Easy9 VTPN DB 8 Ways CVS i/c 250A	250A MCCB+ 24	EZ9EVN08H	20809
Easy9 VTPN DB 12 Ways CVS i/c 250A	250A MCCB+ 36	EZ9EVN12H	25962

Accessories

Description	Type	Reference	Unit MRP [₹]
Easy9 Door Bracket-Set of 5 SSP152	Door Bracket	EZ9EBRACKET	494
Easy9 Std Door Knob-Set of 5 SSP144 GRY	Door Knob	EZ9EDOORKNOB	2992

Note:

Please contact nearest Schneider Electric Sales Office or Customer Care Center for Stockable and Non Stockable status of references

*Bold references are MTO reference.

Wander Plugs



PKE16M423



PKE16M723



81383

- Conforms to IEC 60309-1 & IEC 60309-2
- PK PratiKa Screw Connect: same orientation of clamp's screws
- External impact strength: IK08
- Glow wire test: 850°C

[In] Rated Current (A)	[Ue] Rated Operational Voltage (V)	Poles Description	Reference	Unit MRP [₹]
PratiKa Screw				
IP44				
16	200...250	2P + E	PKE16M423 <input checked="" type="checkbox"/>	725
		2P + E	PKX16M423 <input type="checkbox"/>	1480
	380...415	3P + E	PKE16M434 <input checked="" type="checkbox"/>	927
		3P + N + E	PKE16M435 <input checked="" type="checkbox"/>	966
32	200...250	2P + E	PKE32M423 <input checked="" type="checkbox"/>	1141
		3P + E	PKE32M434 <input checked="" type="checkbox"/>	1338
	380...415	3P + N + E	PKE32M435 <input checked="" type="checkbox"/>	1306
		IP67		
16	200...250	2P + E	PKE16M723 <input checked="" type="checkbox"/>	1585
		2P + E	PKX16M723 <input type="checkbox"/>	2355
	380...415	3P + E	PKE16M734 <input checked="" type="checkbox"/>	1807
		3P + N + E	PKE16M735 <input checked="" type="checkbox"/>	1931
32	200...250	2P + E	PKE32M723 <input checked="" type="checkbox"/>	2264
		3P + E	PKE32M734 <input checked="" type="checkbox"/>	2442
	380...415	3P + N + E	PKE32M735 <input checked="" type="checkbox"/>	2437
		PK (63A & 125A available in IP67 only)		
63	200...250	2P + E	81378	6418
		3P + E	81382 <input checked="" type="checkbox"/>	6117
	380...415	3P + N + E	81383 <input checked="" type="checkbox"/>	6069
125	380...415	3P + E	81394	18715
		3P + N + E	81395	18715

Note: * Fast Connection

Small Wall Mounted Sockets



PKF16W423



PKF16W723



PKF32W735

- Conforms to IEC 60309-1 & IEC 60309-2
- External impact strength: IK08
- Glow wire test: 850°C

[In] Rated Current (A)	[Ue] Rated Operational Voltage (V)	Poles Description	Reference	Unit MRP [₹]
IP44				
16	200...250	2P + E	PKF16W423	1282
		3P + E	PKF16W434	1487
	380...415	3P + N + E	PKF16W435	1624
		200...250	2P + E	PKF32W423
32	380...415	3P + E	PKF32W434	2011
		3P + N + E	PKF32W435	2124
	IP67			
16	200...250	2P + E	PKF16W723	2036
		3P + E	PKF16W734	2558
	380...415	3P + N + E	PKF16W735	2645
		200...250	2P + E	PKF32W723
32	380...415	3P + E	PKF32W734	3721
		3P + N + E	PKF32W735	4936

Note: For all above Reference MOQ = 1

Please contact Customer Care Center for Stockable and Non stockable status of references.

*Bold references are MTO reference.

Wall Mounted Sockets



- Conforms to IEC 60309-1 & IEC 60309-2
- Rated operational voltage upto 415V
- Rated operational current upto 125A
- External impact strength: IK08
- Glow wire test: 850°C
- Available only in IP67

[In] Rated Current (A)	[Ue] Rated Operational Voltage (V)	Poles Description	Reference	Unit MRP [₹]
63	200...250	2P + E	81178	7905
		3P + E	81182 ●	8709
	380...415	3P + N + E	81183	8254
125	380...415	3P + E	81194	28512
		3P + N + E	81195	28651

Wander Sockets



- PK PratiKa Screw Connect: same orientation of clamp's screws.
- PK PratiKa: 16A & 32A; IP44 & IP67
- External impact strength: IK08
- Glow wire test: 850 °C
- Conforms to IEC 60309-1 & IEC 60309-2

[In] Rated Current (A)	[Ue] Rated Operational Voltage (V)	Poles Description	Reference	Unit MRP [₹]
PratiKa Screw				
IP44				
16	200...250	2P + E	PKF16M423 ✓	1014
		2P + E	PKY16M423	1117
	380...415	3P + E	PKF16M434	1170
		3P + N + E	PKF16M435	1277
32	200...250	2P + E	PKF32M423 ✓	1394
	380...415	3P + E	PKF32M434	1693
		3P + N + E	PKF32M435 ✓	1703
IP67				
16	200...250	2P + E	PKF16M723	1878
		2P + E	PKY16M723 ●	2284
	380...415	3P + E	PKF16M734	2355
		3P + N + E	PKF16M735	2460
32	380...415	2P + E	PKF32M723	2582
		3P + E	PKF32M734	2857
	3P + N + E	PKF32M735	2884	
PK (63A & 125A available in IP67 only)				
63	200...250	2P + E	81478	6990
	380...415	3P + E	81482	7051
		3P + N + E	81483	7097
125	380...415	3P + E	81494	22066
		3P + N + E	81495	22498

Also Available on Request:

- Patented FAST connect Plugs & Sockets - innovative cabling system that enables connection without stripping the conductor and with absolutely no screws required
- Extra Low Voltage Plugs & Sockets down to 50V

Please contact nearest Schneider Electric Sales Office or Customer Care for Reference and Prices

Note: For all above Reference MOQ = 1

Please contact Customer Care Center for Stockable and Non stockable status of references.

*Bold references are MTO reference.

Panel Mounted Sockets - Angled



PKF16F423

PKF32F723

81283

- PK PratiKa Screw Connect: same orientation of clamp's screws
- External impact strength: IK08
- Glow wire test: 850°C
- Conforms to IEC 60309-1 & IEC309-2

[In] Rated Current (A)	[Ue] Rated Operational Voltage (V)	Poles Description	Reference	Unit MRP [₹]
PratiKa Screw				
IP44				
16	200...250	2P + E	PKF16F423 <input checked="" type="checkbox"/>	831
		2P + E	PKY16F423 ●	846
	380...415	3P + E	PKF16F434	1170
		3P + N + E	PKF16F435 <input checked="" type="checkbox"/>	1248
32	200...250	2P + E	PKF32F423 <input checked="" type="checkbox"/>	1380
	380...415	3P + E	PKF32F434	1618
		3P + N + E	PKF32F435	1595
IP67				
16	200...250	2P + E	PKF16F723 <input checked="" type="checkbox"/>	1464
	380...415	2P + E	PKY16F723 ●	1790
		3P + E	PKF16F734	1683
32	200...250	3P + N + E	PKF16F735 <input checked="" type="checkbox"/>	1703
	380...415	2P + E	PKF32F723	1924
		3P + E	PKF32F734	2248
		3P + N + E	PKF32F735	2263
PK (63A & 125A available in IP67 only)				
63	200...250	2P + E	81278	6311
	380...415	3P + E	81282 <input checked="" type="checkbox"/>	6322
		3P + N + E	81283 <input checked="" type="checkbox"/>	6385
125	380...415	3P + E	81294	21292
		3P + N + E	81295	21191

Panel Mounted Sockets - Straight



PKF16G423

PKF16G723

81683

- PK PratiKa Screw Connect: same orientation of clamp's screws
- External impact strength: IK08
- Glow wire test: 850°C
- Conforms to IEC 60309-1 & IEC309-2

[In] Rated Current (A)	[Ue] Rated Operational Voltage (V)	Poles Description	Reference	Unit MRP [₹]
PratiKa Screw				
IP44				
16	200...250	2P + E	PKF16G423	889
		2P + E	PKY16G423	1317
	380...415	3P + E	PKF16G434	1549
		3P + N + E	PKF16G435	1338
32	200...250	2P + E	PKF32G423	1410
	380...415	3P + E	PKF32G434	1624
		3P + N + E	PKF32G435	1760
IP67				
16	200...250	2P + E	PKF16G723	1487
	380...415	2P + E	PKY16G723 ●	1676
		3P + E	PKF16G734	2046
32	200...250	3P + N + E	PKF16G735	1703
		2P + E	PKF32G723	1897
	380...415	3P + E	PKF32G734	2134
		3P + N + E	PKF32G735	2214
PK (63A & 125A available in IP67 only)				
63	380...415	3P + E	81682	6384
		3P + N + E	81683	6384
		3P + N + E	81695	21395

*Fast Connection

Note: For all above Reference MOQ = 1

Please contact Customer Care Center for Stockable and Non stockable status of references.

*Bold references are MTO reference.

Sockets with Interlock Switches - for guaranteed safety of operation

- Allows closure of main switch only when the plug is fully inserted in socket - when complete mechanical & electrical connection has occurred
- Plug removal is possible only when the switch is in "off" position

Wall Mounted Sockets with Interlock Switch Unika (w/o protection)



83047

83081

- Switch designed for use in AC 22A class applications
- Conforms to IEC 60309-1 & IEC 60309-2
- Rated operational voltage upto 415V
- Rated operational current upto 32A
- External impact strength: IK08
- Available in IP44 / IP65 versions
- Glow wire test: 750°C

[In] Rated Current (A)	[Ue] Rated Operational Voltage (V)	Poles Description	Reference	Unit MRP [₹]
IP44				
16	200...250	2P + E	83031	10668
	380...415	3P + N + E	83036	15057
32	200...250	2P + E	83042 <input checked="" type="checkbox"/>	13717
	380...415	3P + E	83046	22417
		3P + N + E	83047	16164
IP65				
16	200...250	2P + E	83081	11037
	380...415	3P + E	83085	15200
		3P + N + E	83086	15509
32	200...250	2P + E	83092	14465
	380...415	3P + N + E	83097	17368

Socket with Interlock Switch & DIN Rail Isoblock (4.5 modules)



82754

83796

- Switch designed for use in AC- 22A class applications
- Conforms to IEC 60309-1 & IEC 60309-2
- Provision to DIN mount 4.5 module device
- External impact strength: IK10
- Available in IP65 version
- Glow wire test: 850°C

[In] Rated Current (A)	[Ue] Rated Operational Voltage (V)	Poles Description	Reference	Unit MRP [₹]
16	200...250	2P + E	82754 <input checked="" type="checkbox"/>	13099
	380...415	3P + N + E	82759	20223
32	200...250	2P + E	83791 <input checked="" type="checkbox"/>	15509
	380...415	3P + E	83795	22516
		3P + N + E	83796	18476

Socket with Interlock Switch & DIN Rail Isoblock (6 modules)



82766

- Switch designed for use in AC-22A class applications
- Conforms to IEC 60309-1 & IEC 60309-2
- Provision to DIN mount 6 module device
- External impact strength: IK10
- Available in IP65 version
- Glow wire test: 850°C

[In] Rated Current (A)	[Ue] Rated Operational Voltage (V)	Poles Description	Reference	Unit MRP [₹]
32	200...250	2P + E	82766	20655
63	380...415	3P + E	82782	27832
		3P + N + E	82783	27654

Please contact Customer Care Center for Stockable and Non stockable status of references.

*Bold references are MTO reference.

ELECTRA Metal Clad Plugs & Sockets are specially designed incorporating the latest safety, quality and user friendly features.

Construction

- The casting is made from non-corroding die-cast aluminum alloy combining exceptional compactness with high strength
- The design/construction eliminates the possibility of mismatch in fitting of plugs in corresponding sockets
- The floating contacts in the sockets are self aligning and facilitates smooth plugging in without undue pressure (These can be easily removed for wiring)
- A provision for pilot pin facilitates mechanical interlocking in case of 63A ratings

Human Safety

Specially designed shroud to avoid accidental finger contact with plug-pins while inserting/removing the plug
Similarly, the contact tubes in sockets are deeply recessed to avoid human contact

- The earthing pins ensure that earth connection is made first and broken last, being longer than conducting pins
- The visible earth terminals facilitate easy checking of earth connection
- The cable grip to the plug is made very strong by providing a compression gland and by protecting it at the point of entry by a strong rubber guard

Applications

Industrial, Commercial & Domestic portable equipments like Hand/Power Tools, Industrial Ovens, Welding Sets, Mobile Generators, Furnaces, Ships, Office Machines, Refrigerators, Coolers, Air-Conditioners, Overhead Cranes, Chilling Cabinets, Tile Polishers and Sewing Machines

Plug



Rating (A)	Poles Description	Voltage (V)	MOQ	Reference	Unit MRP [₹]
10	2P	250	30	AP10 <input checked="" type="checkbox"/>	338
20	2P	250	30	AP20 <input checked="" type="checkbox"/>	356
20	3P	440	30	BP20 <input checked="" type="checkbox"/>	474
30	3P	440	20	BP30 <input checked="" type="checkbox"/>	862
63	3P+N+E	440	4	CP63 <input checked="" type="checkbox"/>	3899

Socket



Rating (A)	Poles Description	Voltage (V)	MOQ	Reference	Unit MRP [₹]
10	2P	250	30	AS10 <input checked="" type="checkbox"/>	356
20	2P	250	30	AS20 <input checked="" type="checkbox"/>	380
20	3P	440	30	BS20 <input checked="" type="checkbox"/>	532
30	3P	440	20	BS30 <input checked="" type="checkbox"/>	913
63	3P+N+E	440	4	CS63 <input checked="" type="checkbox"/>	4368

Please contact Customer Care Center for Stockable and Non stockable status of references.
*Bold references are MTO reference.

Complete range of switches & sockets suitable for both indoor & outdoor applications like Kitchens, Swimming Pools, Landscape Gardens, Exterior Walls and Other Environmentally Challenged Locations.



56SW116LE-GY



56SW216LE-GY



56SW332LE-GY

Description	IP Rating	Reference	Unit MRP [₹]
Surface Switches			
Single Pole Switches Less Enclosure			
1 Pole 250V 10A	IP66	56SW110LE-GY	4798
1 Pole 250V 16A	IP66	56SW116LE-GY	4452
1 Pole 250V 20A	IP66	56SW120LE-GY	6741
1 Pole 250V 32A	IP66	56SW132LE-GY	8039
Double Pole Switches Less Enclosure			
2 Pole 500V 16A	IP66	56SW216LE-GY	7766
2 Pole 500V 20A	IP66	56SW220LE-GY	7766
2 Pole 500V 32A	IP66	56SW232LE-GY	10306
2 Pole 500V 50A	IP66	56SW250LE-GY	12036
Triple Pole Switches Less Enclosure			
3 Pole 500V 10A	IP66	56SW310LE-GY	7183
3 Pole 500V 16A	IP66	56SW316LE-GY	7493
3 Pole 500V 20A	IP66	56SW320LE-GY	7888
3 Pole 500V 32A	IP66	56SW332LE-GY	9111
3 Pole 500V 50A	IP66	56SW350LE-GY	10612
3 Pole 500V 63A	IP66	56SW363LE-GY	12318
Four Pole Switches Less Enclosure			
4 Pole 500V 20A	IP66	56SW420LE-GY	11450



66CV563-RG



66P563-EO

Description	IP Rating	Reference	Unit MRP [₹]
IP66 Industrial Combination Switch Sockets with Enclosure			
Single Pole Switches Less Enclosure			
500V, 63A with 4 pole switch and 63A 5 Pin Socket	IP66	66CV563-RG	139606
Plug Top 5 Pin 500V 63A	IP66	66P563-EO	41903

Please contact Customer Care Center for Stockable and Non stockable status of references.

*Bold references are MTO reference.



56SO316RP-LE-GY-EX



56SO432LE-GY



56SO532LE-GY

Description	IP Rating	Reference	Unit MRP [₹]
Surface Socket Outlets			
3 Pin Sockets Less Enclosure			
3 Pin 250V 16A Indian Standard	IP66	56SO316RP-LE-GY-EX	4482
3 Pin 250V 20A Round Pin	IP66	56SO320LE-GY	6505
3 Pin 250V 32A Round Pin	IP66	56SO332LE-GY	7246
4 Pin Sockets Less Enclosure			
4 Pin 500V 20A Round Pin	IP66	56SO420LE-GY	9718
4 Pin 500V 32A Round Pin	IP66	56SO432LE-GY	11619
4 Pin 500V 50A Round Pin	IP66	56SO450LE-GY	17878
5 Pin Sockets Less Enclosure			
5 Pin 500V 10A Round Pin	IP66	56SO510LE-GY	10500
5 Pin 500V 20A Round Pin	IP66	56SO520LE-GY	10401
5 Pin 500V 32A Round Pin	IP66	56SO532LE-GY	12351
5 Pin 500V 40A Round Pin	IP66	56SO540LE-GY	17992
5 Pin 500V 50A Round Pin	IP66	56SO550LE-GY	18471

*Alternate reference 56SO440-GY (coming soon)



56PA420-EO



56PA532-EO



56CVI520-GY

Description	IP Rating	Reference	Unit MRP [₹]
Plugs			
3 Pin Angle Plugs			
3 pin 250V 16A Round Pin	IP66	56PA316RP-GY-EX	3371
3 Pin 250V 20A Round Pin	IP66	56PA320-EO	6741
3 Pin 250V 32A Round Pin	IP66	56PA332-EO	7788
4 Pin Angle Plugs			
4 Pin 500V 20A Round Pin	IP66	56PA420-EO	8294
4 Pin 500V 32A Round Pin	IP66	56PA432-EO	8634
4 Pin 500V 40A Round Pin	IP66	56PA440-EO	14360
4 Pin 500V 50A Round Pin	IP66	56PA450-EO	10245
5 Pin Angle Plugs			
5 Pin 500V 10A Round Pin	IP66	56PA510-EO	8152
5 Pin 500V 20A Round Pin	IP66	56PA520-EO	8152
5 Pin 500V 32A Round Pin	IP66	56PA532-EO	9329
5 Pin 500V 40A Round Pin	IP66	56PA540-EO	9961
5 Pin 500V 50A Round Pin	IP66	56PA550-EO	10198
Combination Switch Socket Outlet			
IP66 Interlocked Switch Socket with Enclosure			
4 Pin 500V 20A Round Pin	IP66	56CVI420-GY	35635
5 Pin 500V 20A Round Pin	IP66	56CVI520-GY	32239
5 Pin 500V 32A Round Pin	IP66	56CVI532-GY	32533

Please contact Customer Care Center for Stockable and Non stockable status of references.

*Bold references are MTO reference.

56 Series

Description	Module Width	Reference	Unit MRP [₹]
Switchgear Cover Assembly			
For 1,2,3 Pole MCB with 4 Pole RCD (max. 4M Width)	4	56CB4N-GY	7388



Description	No. of Gangs	Reference	Unit MRP [₹]
Flush Surrounds			
Flush Surround	2	56FA2-GY	3640
Flush Surround	3	56FA3-GY	5731
Mounting Enclosures (Back Boxes)			
101X101X63mm	1	56E1-GY	1568
198X101X63mm	2	56E2-GY	4023

Please contact Customer Care Center for Stockable and Non stockable status of references.
 *Bold references are MTO reference.

SWITCH TO STYLE



Perfect solutions for the perfect you



Anti-Bacterial
Range

LIVIA
Life. Style.



Miluz ZeTa



Opale



Unica Pure



ZENcelo



Avatar On



- **Sleek Design** - 2.7mm thin plate with curved body to minimize dust accumulation
- **Stylish Looks** - Soft white texture with glossy finish
- **Robust & Strong** - Innovative honeycomb designed grid plate for extra rigidity
- **Reliable** - High grade heat-resistant polycarbonate and laser marked wiring diagrams.
- **Easy to Install** - Snap-In / Snap-Out front loading modules and Bigger terminal holes
- **Green & Eco Friendly** - RoHS compliant range



P1001



P1081



P1002



P1025



P2005NS



P2106



P3012



P3200



P7003



P7003_PG



P6005



P5001



P3301



P3301_PG



P8010



P8010_PG

Description	Reference for White	Unit MRP [₹]	Reference for Pristine Grey	Unit MRP [₹]
Switches 10AX / 16AX				
10AX 1 way switch	P1001_P	162	P1001_PG_P	228
10AX 1 way switch with Indicator lamp	P1081_P	341	P1081_PG_P	467
10AX 2 way switch	P1002_P	266	P1002_PG_P	329
16AX 1 way switch	P1101_P	290	P1101_PG_P	355
16AX 1 way switch with Indicator lamp	P1181_P	403	P1181_PG_P	479
16AX 1 way switch (2M)	P1121_P	452	P1121_PG_P	590
16AX 2 way switch	P1102_P	397	P1102_PG_P	542
Switches 20A / 32A				
20A 1 way switch (1M) with indicator lamp	P11201	373	P11201_PG	476
20A DP switch with Indicator lamp	P1120	674	P1120_PG	926
32A DP switch with Indicator lamp	P1132	968	P1132_PG	1199
Bell Push				
10A Bell Push switch	P1005_P	297	P1005_PG_P	405
10A Bell Push switch (2M)	P1025_P	436	P1025_PG_P	610
10A bell push switch with Indicator	P1085_P	364	P1085_PG_P	495
10A bell push switch with Indicator (2M)	P1086_P	475	P1086_PG_P	651
Sockets				
6A 3Pin socket Outlet with shutter (BIS)	P2005NS_P	309	P2005NS_PG_P	380
10A/16A 3-pin Socket Outlet with Shutter	P2106_P	464	P2106_PG_P	563
Fan Regulators & Dimmers				
Step type fan regulator (1M)	P3100	948	P3100_PG	1153
Step type fan regulator (2M)	P3200	1088	P3200_PG	1359
Dimmer 400W (1M)	P3004	1788	P3004_PG	2335
Dimmer 1000W (2M)	P3012	2619	P3012_PG	2871
USB Charger				
USB Charger	P7002	2340	P7002_PG	2720
Livia - A+C Type USB Charger (1M)	P7003	3523	P7003_PG	4241
Accessories				
RJ 11 Telephone outlet with shutter	P4011	268	P4011_PG	369
RJ 45 Cat 5e Data outlet with shutter	P4045	908	P4045_PG	1089
RJ 45 Cat6 Data outlet with shutter	P4046	1011	P4046_PG	1288
TV socket	P4500	255	P4500_PG	353
Blank off unit (1M)	P0001	70	P0001_PG	92
Foot Lamp with LED	P7001	1116	P7001_PG	1329
Cord Outlet	-	-	P4550_PG	402
LED Phase Indicator	P5001	444	-	
Door Chime 2M				
10A Mini MCB	P8010	638	P8010_PG	749
16A Mini MCB	P8016	638	P8016_PG	749
20A Mini MCB	P8020	638	P8020_PG	749
25A Mini MCB	P8025	638	P8025_PG	749
32A Mini MCB	P8032	638	P8032_PG	749

* Available till stocks lasts

Please contact Customer Care Center for Stockable and Non stockable status of references.

*Bold references are MTO reference.



P6002



P6004



P6011



P6011_PG

New

Description	Reference for White	Unit MRP [₹]	Reference for Pristine Grey	Unit MRP [₹]
Motor Starter Switch				
25A Motor Starter switch	P1186MS	1656	P1186MS_PG	2244
Hotel Series				
DND Switch	P6002	392	P6002_PG	447
MMR Switch	P6004	392	P6004_PG	447
DND & MMR Indicator	P6013	1106	P6013_PG	1424
20A Key Card Switch - Electronic (3M)	P6005	5966	P6005_PG	7954
Shaver Socket	P6011	3600	P6011_PG	4320



P0703



P0704



P0706_PG

Description	Reference for White	Unit MRP [₹]	Reference for Pristine Grey	Unit MRP [₹]
Cover Plates				
1-2M grid & 1M cover frame	P0701	182	P0701_PG	235
1-2M grid & 2M cover frame	P0702	181	P0702_PG	219
3M grid & 3M cover frame	P0703	229	P0703_PG	257
4M grid & 4M cover frame	P0704	265	P0704_PG	319
6M grid & 6M cover frame	P0706	336	P0706_PG	418
8M grid & 8M cover frame - linear	P0708	444	P0708_PG	525
8M grid & 8M cover frame - square	P0709	523	P0709_PG	713
9 M Grid & Cover Plate	P07010	497	P07010_PG	661
12M Grid & Cover Plate	P0712	649	P0712_PG	762
16M Grid & cover frame	P07016	772	P07016_PG	900
18M Grid and cover Plate	P0718	952	P0718_PG	1243



P0706_CM



P0704_FS

New

Description	Antique Bronze	Unit MRP [₹]	Frosted Silver	Unit MRP [₹]	Champagne Mist	Unit MRP [₹]
Cover Frame						
1-2M grid & 1M cover frame	P0701_AB	235	P0701_FS	235	P0701_CM	235
1-2M grid & 2M cover frame	P0702_AB	219	P0702_FS	219	P0702_CM	219
3M grid & 3M cover frame	P0703_AB	257	P0703_FS	257	P0703_CM	257
4M grid & 4M cover frame	P0704_AB	319	P0704_FS	319	P0704_CM	319
6M grid & 6M cover frame	P0706_AB	418	P0706_FS	418	P0706_CM	418
8M grid & 8M cover frame - linear	P0708_AB	525	P0708_FS	525	P0708_CM	525
8M grid & 8M cover frame - square	P0709_AB	713	P0709_FS	713	P0709_CM	713
9 M Grid & Cover Plate	P07010_AB	661	P07010_FS	661	P07010_CM	661
12M Grid & Cover Plate	P0712_AB	762	P0712_FS	762	P0712_CM	762
16M Grid & cover frame	P07016_AB	900	P07016_FS	900	P07016_CM	900
18M Grid and cover Plate	P0718_AB	1243	P0718_FS	1243	P0718_CM	1243

Please contact Customer Care Center for Stockable and Non stockable status of references.

*Bold references are MTO reference.



Miluz ZeTa

Little things, big impact

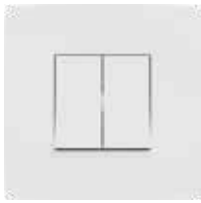

Glossy White
+Glossy White switch



Matte Anthracite
+Matt Anthracite Switch



Metallic Champagne Gold
+Anthracite switch



Metallic Warm Grey
+Metallic Warm Grey Switch



Metallic Silver Grey
+Anthracite switch

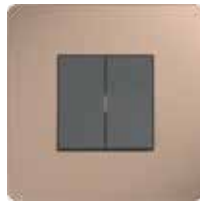

Metallic Bronze
+Anthracite switch

A Smarter Way to Live:

- Unique 'see-saw' design offering a 'crisp click' experience
- Sleek cover frame shows off a simple yet elegant design
- 6 curated color frames with 3 switch color options

Durability and Safety:

- The durable copper contact offers enhanced durability and lifespan
- No single pin insertion – offers utmost safety

Effortless Installation:

- Slotted screws – to facilitate easy & quick installation
- Easy universal alignment – Vertical & Horizontal mounting to optimize space and add flexibility
- Keyhole feature on grid plates enables faster installation

Seamless Connectivity:

- Seamless compatibility with Wiser™

Sustainability:

- RoHS, REACH, PEP, EoLI compliance for the highest Environmental Data standards
- Brown paper packaging for better ecological impact

Now Miluz ZeTa comes with the 10 years of warranty



MZSW101M1W_WH



MZSWI202MDP_WH



MZSW101M1W_AN



MZSW101M2W_AN



MZSW101M1W_WG



MZSWI202MDP_WG

Description	Reference for White	Unit MRP [₹]	Box Qty.	Reference for Anthracite	Unit MRP [₹]	Box Qty.	Reference for Warm Grey	Unit MRP [₹]	Box Qty.
Switches									
10A 1 Way Switch	MZSW101M1W_WH	160	20	MZSW101M1W_AN	192	20	MZSW101M1W_WG	192	20
10A 1 Way Switch (2M)	MZSW102M1W_WH	364	10	MZSW102M1W_AN	437	10	MZSW102M1W_WG	437	10
10A 1 Way Switch with Indicator	MZSWI101M1W_WH	353	20	MZSWI101M1W_AN	423	20	MZSWI101M1W_WG	423	20
10A 1W Switch with Ind (2M)	MZSWI102M1W_WH	430	10	MZSWI102M1W_AN	516	10	MZSWI102M1W_WG	516	10
10A 2 Way Switch	MZSW101M2W_WH	292	20	MZSW101M2W_AN	351	20	MZSW101M2W_WG	351	20
16A 1 Way Switch	MZSW161M1W_WH	320	20	MZSW161M1W_AN	384	20	MZSW161M1W_WG	384	20
16A 1 Way Switch (2M)	MZSW162M1W_WH	551	10	MZSW162M1W_AN	662	10	MZSW162M1W_WG	662	10
16A 1 Way Switch with Indicator	MZSWI161M1W_WH	436	20	MZSWI161M1W_AN	523	20	MZSWI161M1W_WG	523	20
16A 1W Switch with Indicator (2M)	MZSWI162M1W_WH	607	10	MZSWI162M1W_AN	728	10	MZSWI162M1W_WG	728	10
16A 2Way Switch	MZSW161M2W_WH	497	20	MZSW161M2W_AN	596	20	MZSW161M2W_WG	596	20
20A DP Switch with Indicator (2M)	MZSWI202MDP_WH	771	10	MZSWI202MDP_AN	924	10	MZSWI202MDP_WG	924	10
32A DP Switch with Indicator (2M)	MZSWI322MDP_WH	1272	10	MZSWI322MDP_AN	1526	10	MZSWI322MDP_WG	1526	10

Please contact Customer Care Center for Stockable and Non stockable status of references.

*Bold references are MTO reference.



MZSWI202MDP_WG



MZMOTSTR2M_AN



MZMOTSTR2M_WG

Description	Reference for White	Unit MRP [₹]	Box Qty.	Reference for Anthracite	Unit MRP [₹]	Box Qty.	Reference for Warm Grey	Unit MRP [₹]	Box Qty.
Motor Starter Switch									
25A Motor Starter Switch	MZMOTSTR2M_WH	1809	10	MZMOTSTR2M_AN	2171	10	MZMOTSTR2M_WG	2171	10



MZBP1M_WH



MZBP1M_AN



MZBP2M_WG

Description	Reference for White	Unit MRP [₹]	Box Qty.	Reference for Anthracite	Unit MRP [₹]	Box Qty.	Reference for Warm Grey	Unit MRP [₹]	Box Qty.
Bell Push Switch									
6A Bell Push	MZBP1M_WH	309	20	MZBP1M_AN	348	20	MZBP1M_WG	348	20
6A Bell Push (2M)	MZBP2M_WH	463	10	MZBP2M_AN	521	10	MZBP2M_WG	521	10
6A Bell Push with Indicator	MZBP1M_WH	397	20	MZBP1M_AN	447	20	MZBP1M_WG	447	20
6A Bell Push with Indicator (2M)	MZBP2M_WH	541	10	MZBP2M_AN	608	10	MZBP2M_WG	608	10



MZSO6162M3P_WH



MZSO62M3P_AN



MZSO62M3P_WG

Description	Reference for White	Unit MRP [₹]	Box Qty.	Reference for Anthracite	Unit MRP [₹]	Box Qty.	Reference for Warm Grey	Unit MRP [₹]	Box Qty.
Sockets									
6A/16A 3P Socket with Shutter	MZSO6162M3P_WH	461	10	MZSO6162M3P_AN	575	10	MZSO6162M3P_WG	575	10
6A 3 Pin Socket with Shutter	MZSO62M3P_WH	276	10	MZSO62M3P_AN	350	10	MZSO62M3P_WG	350	10



MZFR4STP1M_WH



MZFR5STP2M_AN



MZDMRUNI1M_WG

Description	Reference for White	Unit MRP [₹]	Box Qty.	Reference for Anthracite	Unit MRP [₹]	Box Qty.	Reference for Warm Grey	Unit MRP [₹]	Box Qty.
Fan Regulators & Dimmers									
4-Step Fan Regulator (1M)	MZFR4STP1M_WH	1001	20	MZFR4STP1M_AN	1201	20	MZFR4STP1M_WG	1317	20
5-Step Fan Regulator (2M)	MZFR5STP2M_WH	1192	10	MZFR5STP2M_AN	1431	10	MZFR5STP2M_WG	1569	10
400W Dimmer (1M)	MZDMR1M_WH	1448	10	MZDMR1M_AN	1737	10	MZDMR1M_WG	1905	10



MZUSBAC2MPDH_WH



MZUSBAC1M_AN



MZUSBAC1M_WG

Description	Reference for White	Unit MRP [₹]	Box Qty.	Reference for Anthracite	Unit MRP [₹]	Box Qty.	Reference for Warm Grey	Unit MRP [₹]	Box Qty.
USB Charger									
2.1A USB Charger (1M)	MZUSBA1M_WH	2474	10	MZUSBA1M_AN	2968	10	MZUSBA1M_WG	2968	10
1M 12W A+C Type USB Charger	MZUSBAC1M_WH	3430	20	MZUSBAC1M_AN	4115	20	MZUSBAC1M_WG	4115	20
A+C USB Charger PD HziI 2M	MZUSBAC2MPDH_WH	4994	10	MZUSBAC2MPDH_AN	5992	10	MZUSBAC2MPDH_WG	5992	10

*Prices will be shared on request

Please contact Customer Care Center for Stockable and Non stockable status of references.

*Bold references are MTO reference.



MZRJ111M_WH



MZHDMI1M_WH



MZBLANK1M_AN



MZTV1M_AN



MZRJ111M_WG



MZTV1M_WG

Description	Reference for White	Unit MRP [₹]	Box Qty.	Reference for Anthracite	Unit MRP [₹]	Box Qty.	Reference for Warm Grey	Unit MRP [₹]	Box Qty.
Accessories									
RJ11 Tel Shuttered 1M	MZRJ111M_WH	302	10	MZRJ111M_AN	362	10	MZRJ111M_WG	362	10
RJ45 Cat6 Outlet Shuttered 1M	MZRJ451M_WH	1102	10	MZRJ451M_AN	1323	10	MZRJ451M_WG	1323	10
TV Socket 1M	MZTV1M_WH	284	10	MZTV1M_AN	341	10	MZTV1M_WG	341	10
Preterminated HDMI socket 1M	MZHDMI1M_WH	1925	10	MZHDMI1M_AN	2311	10	MZHDMI1M_WG	2311	10
Door Chime 2M	MZDRCHM2M_WH	1867	10	MZDRCHM2M_AN	2241	10	MZDRCHM2M_WG	2241	10
Blank Off Unit (1M)	MZBLANK1M_WH	72	20	MZBLANK1M_AN	87	20	MZBLANK1M_WG	87	20
LED PhaseInd (Red)	MZPHSIND1M_RD	409	10	-	-	-	-	-	-
IP Cover 2M, Grey	MZIPCVR2M_GY*	1092	-	-	-	-	-	-	-
IP Cover 3M, Grey	MZIPCVR3M_GY*	1559	-	-	-	-	-	-	-



MZKECRDSW2M_WH



MZDMSW2M_WH



MZKECRDSW2M_AN



MZDMSW2M_AN



MZKECRDSW2M_WG



MZDMSW2M_WG

Description	Reference for White	Unit MRP [₹]	Box Qty.	Reference for Anthracite	Unit MRP [₹]	Box Qty.	Reference for Warm Grey	Unit MRP [₹]	Box Qty.
Hotel Series									
Electronic Keycard Switch 2M	MZKECRDSW2M_WH	5960	4	MZKECRDSW2M_AN	7151	4	MZKECRDSW2M_WG	7151	4
DND MMR Switch (2M)	MZDMSW2M_WH	1050	10	MZDMSW2M_AN	1261	10	MZDMSW2M_WG	1261	10
110V Shaver Socket Horizontal	MZSHVRSO3M_WH	5350	1	MZSHVRSO3M_AN	6420	1	MZSHVRSO3M_WG	6420	1
DND MMR Indicator	MZDMI1M_NA	817	10	-	-	-	-	-	-



MZSWSO62M_WH



MZAQI2M_AN



MZVSP1M_WG



MZFTLMP2M_AN

Description	Reference for White	Unit MRP [₹]	Box Qty.	Reference for Anthracite	Unit MRP [₹]	Box Qty.	Reference for Warm Grey	Unit MRP [₹]	Box Qty.
Innovative Functions									
6A Switched Socket 2M	MZSWSO62M_WH	497	10	MZSWSO62M_AN	630	10	MZSWSO62M_WG	630	10
Air Quality Indicator, 2M	MZAQI2M_WH*	21310	-	MZAQI2M_AN*	21741	-	MZAQI2M_WG*	21741	-
Voltage Surge Protector 1M	MZVSP1M_WH	3013	10	MZVSP1M_AN	3615	10	MZVSP1M_WG	3615	10
Foot lamp 2M	MZFTLMP2M_WH	1242	10	MZFTLMP2M_WG	1398	10	MZFTLMP2M_AN	1398	10
Foot lamp with Motion Sensor 2M	MZFTLMPSEN2M_WH*	4669	-	MZFTLMPSEN2M_AN*	5603	-	MZFTLMPSEN2M_WG*	5603	-



MZMM161P_WH



MZMM161P_AN



MZMM161P_WG

Description	Reference for White	Unit MRP [₹]	Box Qty.	Reference for Anthracite	Unit MRP [₹]	Box Qty.	Reference for Warm Grey	Unit MRP [₹]	Box Qty.
MCB									
16 A MCB SP 1 M C curve	MZMM161P_WH	992	10	MZMM161P_AN	1191	10	MZMM161P_WG	1191	10
20 A MCB SP 1 M C curve	MZMM201P_WH	992	10	MZMM201P_AN	1191	10	MZMM201P_WG	1191	10
32 A MCB SP 1 M C curve	MZMM321P_WH	992	10	MZMM321P_AN	1191	10	MZMM321P_WG	1191	10

*Prices will be shared on request

Please contact Customer Care Center for Stockable and Non stockable status of references.

*Bold references are MTO reference.



MZCP1M_WH



MZCP6M_AN



MZCP4M_WG

Description	Reference for White	Unit MRP [₹]	Box Qty.	Reference for Anthracite	Unit MRP [₹]	Box Qty.	Reference for Warm Grey	Unit MRP [₹]	Box Qty.
Cover Plates									
1M or 2M Grid & 1M Cover Frame	MZCP1M_WH	205	20	MZCP1M_AN	257	20	MZCP1M_WG	257	20
1M or 2M Grid & 2M Cover Frame	MZCP2M_WH	205	20	MZCP2M_AN	257	20	MZCP2M_WG	257	20
3M Grid & 3M Cover Frame	MZCP3M_WH	259	10	MZCP3M_AN	324	10	MZCP3M_WG	324	10
3M Uni Grid & 3M Cover Frame	MZCP3MU_WH	283	10	MZCP3MU_AN	354	10	MZCP3MU_WG	354	10
4M Grid & 4M Cover Frame	MZCP4M_WH	301	14	MZCP4M_AN	376	14	MZCP4M_WG	376	14
6M Grid & 6M Cover Frame	MZCP6M_WH	401	5	MZCP6M_AN	501	5	MZCP6M_WG	501	5
8M Grid & 8M Cover Frame Linear	MZCP8MH_WH	507	5	MZCP8MH_AN	635	5	MZCP8MH_WG	635	5
8M Grid & 8M Cover Frame Square	MZCP8MS_WH	684	5	MZCP8MS_AN	855	5	MZCP8MS_WG	855	5
9M Cover Frame + 8M Grid	MZCP9M_WH	649	5	MZCP9M_AN	811	5	MZCP9M_WG	811	5
12M Grid & 12M Cover Frame	MZCP12M_WH	825	5	MZCP12M_AN	1031	5	MZCP12M_WG	1031	5
16M Cover Frame & Grid	MZCP16M_WH	991	5	MZCP16M_AN	1239	5	MZCP16M_WG	1239	5
18M Grid & 18M Cover Frame	MZCP18M_WH	1144	5	MZCP18M_AN	1430	5	MZCP18M_WG	1430	5



MZCP3MU_CG



MZCP2M_SG

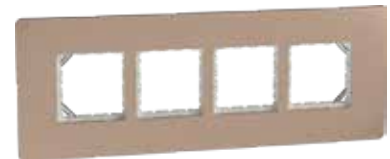

MZCP8M_BZ

Description	Reference for Champagne Gold	Unit MRP [₹]	Box Qty.	Reference for Silver Grey	Unit MRP [₹]	Box Qty.	Reference for Bronze	Unit MRP [₹]	Box Qty.
Cover Plates									
1M or 2M Grid & 1M Cover Frame	MZCP1M_CG	257	20	MZCP1M_SG	257	20	MZCP1M_BZ	257	20
1M or 2M Grid & 2M Cover Frame	MZCP2M_CG	257	20	MZCP2M_SG	257	20	MZCP2M_BZ	257	20
3M Grid & 3M Cover Frame	MZCP3M_CG	324	10	MZCP3M_SG	324	10	MZCP3M_BZ	324	10
3M Uni Grid & 3M Cover Frame	MZCP3MU_CG	354	10	MZCP3MU_SG	354	10	MZCP3MU_BZ	354	10
4M Grid & 4M Cover Frame	MZCP4M_CG	376	14	MZCP4M_SG	376	14	MZCP4M_BZ	376	14
6M Grid & 6M Cover Frame	MZCP6M_CG	501	5	MZCP6M_SG	501	5	MZCP6M_BZ	501	5
8M Grid & 8M Cover Frame Linear	MZCP8MH_CG	635	5	MZCP8MH_SG	635	5	MZCP8MH_BZ	635	5
8M Grid & 8M Cover Frame Square	MZCP8MS_CG	855	5	MZCP8MS_SG	855	5	MZCP8MS_BZ	855	5
9M Cover Frame + 8M Grid	MZCP9M_CG	811	5	MZCP9M_SG	811	5	MZCP9M_BZ	811	5
12M Grid & 12M Cover Frame	MZCP12M_CG	1031	5	MZCP12M_SG	1031	5	MZCP12M_BZ	1031	5
16M Cover Frame & Grid	MZCP16M_CG	1239	5	MZCP16M_SG	1239	5	MZCP16M_BZ	1239	5
18M Grid & 18M Cover Frame	MZCP18M_CG	1430	5	MZCP18M_SG	1430	5	MZCP18M_BZ	1430	5

Please contact Customer Care Center for Stockable and Non stockable status of references.
*Bold references are MTO reference.

Wiring Diagram Miluz ZeTa

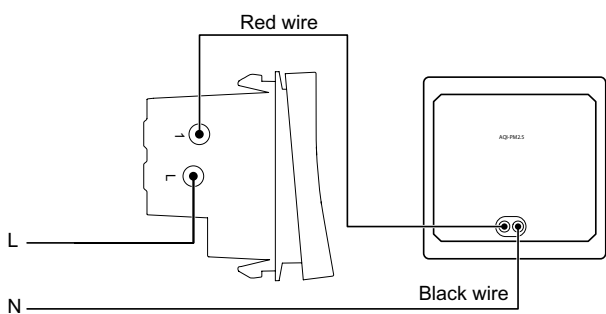

> Air Quality Indicator

MZAQI2M_WH, MZAQI2M_AN, MZAQI2M_WG

Universal LED Dimmer

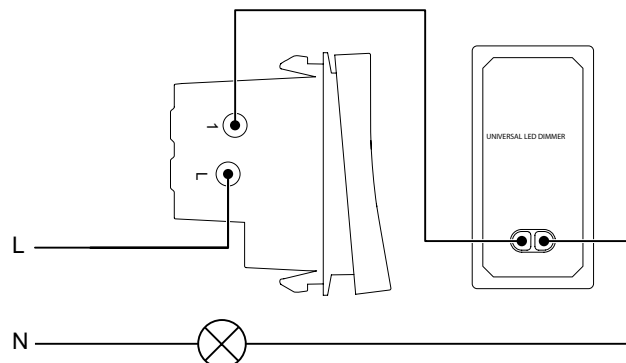

> Dimmer

MZDMRUNI1M_WH, MZDMRUNI1M_AN,
MZDMRUNI1M_WG

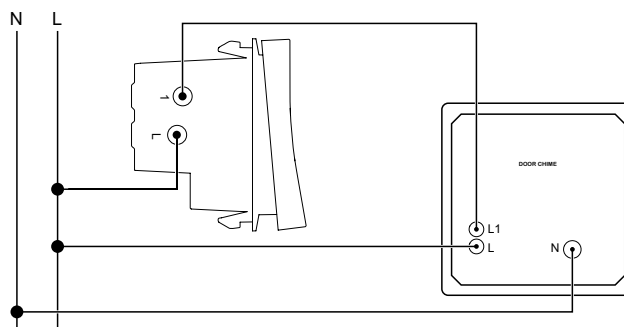

> Door Chime

MZDRCHM2M_WH, MZDRCHM2M_AN, MZDRCHM2M_WG

10 Years Warranty T&C

- Schneider Electric shall, at its sole discretion, repair or replace switches upto 16A (without LED indicator/lamp) and or 6A & 16A sockets in white color only if the Product is found to be having manufacturing defect (means defects solely as a result of faulty material and/or workmanship during manufacturing of Product) within 10 years from the date of manufacture of Product or from the date of invoice of Product, whichever is earlier.
- For all other wiring accessories, the warranty shall be 18 months starting from the date of delivery or 24 months from the date of manufacturing, whichever is earlier
- The warranty defines Schneider Electric's overall sole liability which does not include any other liability whatsoever including without limitation consequential losses or damages or re-installation costs arising from or in relation to the defective products.
- Schneider Electric reserves the right to change and/or improve the design of its Products without prior notice
- In any event whatsoever, if same Product with a similar design is not available, the Product will be replaced with an equivalent model available at that time at sole discretion of Schneider Electric.
- ***This warranty for the above products shall be rendered null & void in case of the following:***
 - a. If the original Schneider Electric mounting boxes have not been used to mount the plates & accessories.
 - b. If any attempt has been made to rectify, dismantle, tamper, or alter the product by any third party or by the customer himself.
 - c. If any damage resulting from the use of any cleaning chemicals on the Product which can adversely affect the product material (Like Acetone, Thinner, turpentine Oil etc.)
 - d. If the products are not installed as per the appropriate design specifications
- Warranty facilitations as per the standard process where customer to contact Customer Care Center (Email, Toll Free, chat) with relevant details & Log the complaint.

Opale - Switches with Satin Finish



- **Patented Smooth Satin Finish** - Scratch Resistant, Easy to Clean & Prevents light reflection off surface
- **Safe to Use** - High grade flame retardant polycarbonate material & Child Proof sockets with unique shutter design
- **Hassle Free Operation** - 'Soft sound' switches with Gold plated Data Socket contacts for better connection
- **Easy to Install** - Snap-In / Snap-Out front loading modules and terminals with indented screws
- **Green & Eco Friendly** - RoHS compliant range



X1001WH



X1286WH



X1186WH



X1005WH



X1085WH



X2005WHNS



X2106WH



X3200WHCM



X3104WH



X7003WH



X5001

Description	Reference for White	Unit MRP [₹]	Pack	Reference for Coke Grey	Unit MRP [₹]	Pack
Switches						
6AX 1 way switch	X1001WH	293	20	AAKY1001	371	20
6AX 1 way switch with Indicator lamp	X1081WH	549	20	-	-	-
6AX 2 way switch	X1002WH	410	20	-	-	-
16AX 1 way switch	X1101WH	469	20	AAKY1101	593	20
16AX 1 way switch with Indicator lamp	X1181WH	671	20	AAKY1181	784	20
16AX 2 way switch	X1102WH	633	20	-	-	-
20A DP switch with Indicator (2M)	X1286WH	1109	10	-	-	-
32A DP switch (2M)	AAKX1232	1696	10	-	-	-
Motor Starter Switch						
25A Motor Starter switch	X1186WH	3195	10	-	-	-
Bell Push						
6A Bell Push	X1005WH	459	20	-	-	-
6A Bell Push (2M)	X1025WH	657	10	-	-	-
6A Bell Push with Indicator	X1085WH	916	20	-	-	-
Sockets						
6A 3-Pin Socket Outlet with Shutter (BIS)	X2005WHNS	500	10	AAXY2005NS	603	10
6A/16A 3-Pin Socket Outlet with Shutter	X2106WH	771	10	-	-	-
Fan Regulators & Dimmers						
Step Fan Regulator (1M)	X3100CMWH	1327	10	AAXY3100CM	1654	10
Step Type Fan Regulator (2M)	X3200WHCM	1806	5	AAXY3200CM	2266	5
Dimmer 400W (1M)	X3104WH	1673	10	-	-	-
Dimmer 400W (2M)	X3004WH	2603	5	-	-	-
USB Chargers						
2 Gang USB Charger - 2.1A (2M)	X7003WH	4942	15	-	-	-
Accessories						
RJ11 Telephone outlet with shutter	X4011WH	419	10	-	-	-
RJ45 Data Outlet with shutter	X4045WH	1443	20	-	-	-
TV Socket	X4500WH	392	10	-	-	-
RJ45 Cover for Key Stone Type	X4050WH	581	10	-	-	-
Buzzer	X3300WH	1876	2	-	-	-
Blank off unit (1M)	X0001WH	108	10	-	-	-
Neon Phase Indicator (Red)	X5001	665	20	-	-	-

Please contact Customer Care Center for Stockable and Non stockable status of references.
*Bold references are MTO reference.

Opale - Switches with Satin Finish



AAKX6006



AAKX6005

Description	Reference	Unit MRP [₹]	Pack
Hotel Series*			
Key Tag Switch (Mechanical Type 20 A)	AAKX6005	2503	1
Shaver Socket	AAKX6006	11040	1

*Available in white colour only



X0703



X0704



X0708

Description	Reference for White	Unit MRP [₹]	Pack	Reference for Coke Grey	Unit MRP [₹]	Pack
Cover Plates						
1-2 M Grid & 1 M Cover Frame	X0701	266	10	AAKY0801	351	10
1-2 M Grid & 2 M Cover Frame	X0702	282	10	-	-	-
3 M Grid & 3 M Cover Frame	X0703	333	10	-	-	-
4 M Grid & 4 M Cover Frame	X0704	391	10	-	-	-
6 M Grid & 6 M Cover Frame	X0706	545	5	AAKY0806	652	5
8 M Grid & 8 M Cover Frame - Horizontal	X0708	708	5	-	-	-
8 M Grid & 8 M Cover Frame - Square	X0709	846	5	-	-	-
12 M Grid & 12 M Cover Frame	X0712	1004	5	-	-	-
18 M Grid & 18 M Cover Frame	AAKX0718	1309	5	-	-	-

Please contact Customer Care Center for Stockable and Non stockable status of references.

*Bold references are MTO reference.

Unica Pure - Irresistibly Beautiful



Wood



Glass



Metal Rhodium Black



Sandy Beige

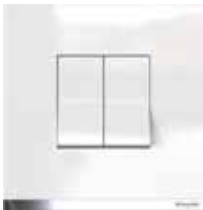

Polar White



Volcanic Grey



Pearl Black



Pewter Grey



Oak

Irresistibly Beautiful

- Authentic finishes - developed from the high quality natural material
- Ingenious Design - Demarcated dolly depicting clear on/off mode of the switch
- Modish Colors - perfectly gel with neutral, accent wall colors and blends perfectly with any decor

Irresistibly Safe & Sturdy

- Self Piercing Terminal - ensuring completely safe, robust and fast installation
- Facile & Guarded Technology - reduces tension in the switch rocker & increases the longevity of the switch
- Plated metal with Plastic over molded Gridplate - Robust, rigid & shock proof gridplate, ensuring durable installation on the metal box

Irresistibly Easy

- Key Hole Feature - Angular and linear adjustments of the gridplate can be easily achieved
- Revolutionary Ease of Mounting with Indicators & Markings

Irresistibly Sustainable

- Green Premium - Complies to HIGHEST INTERNATIONAL STANDARD of Green Certification for manufactured products (RoHS, REACH, PEP, EoLI) and is 100% Recyclable

Irresistibly Innovative

- Future Ready - Features of Voice & Mobile control to fit with smart homes

Irresistibly Versatile

- One Stop Shop - Extensive range covering residential, office, commercial or hospitality
- **Intermediate switches to control multiple 2way switches**

Unica Pure switches with six patented technologies



Life Guarded Sockets

Eliminate possibility of Single Pin Insertion making it extra safe for children

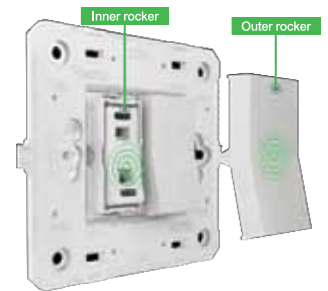

Facile & Guarded Technology

Reduces tension in the switch rocker & increases the longevity of the switch

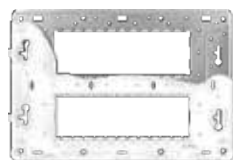

Key Hole Feature

Angular and linear adjustments of the gridplate can be easily achieved



Adjoining (V) Feature Technology

Ensuring perfect alignment of switches

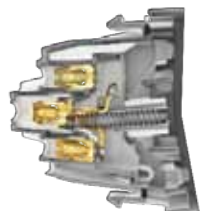

Self-piercing Terminal

Ensuring completely safe, robust and fast installation

Unica Pure - Irresistibly Beautiful



UNS61SW1M_WE



UNS161SWL1M_WE



UNS162MSWL1M_WE



UNS10SW1M_WE



UNS162SW2M_WE



UNSMTSTART2M_WE



UNS616SK2M_WE



UNSSWSO62M_GY



UNSUSBAC2MPDH_WE



UNSACUSB1P1M_WE



UNS5STFAN2M_WE



UNSHDMI_WE



UNSCPTVDIG1M_WE

Description	Reference for Polar White	Unit MRP	Pack	Reference for Volcanic Grey	Unit MRP	Pack
6A Switches						
6AX 1 Way Switch	UNS61SW1M_WE	253	20	UNS61SW1M_GY	295	20
6AX 1 Way Switch With Indicator	UNS61SWL1M_WE	457	20	UNS61SWL1M_GY	524	20
6AX 2 Way Switch	UNS62SW1M_WE	367	10	UNS62SW1M_GY	411	10
10A Intermediate Switches						
10AX Intermediate Switch	UNS10SW1M_WE	1707	1	UNS10SW1M_GY	2059	1
16AX Switches						
16AX 1 Way Switch	UNS161SW1M_WE	422	20	UNS161SW1M_GY	492	20
16AX 1 Way Switch With Indicator	UNS161SWL1M_WE	505	20	UNS161SWL1M_GY	587	20
16AX 2 Way Switch, Polar White	UNS162SW1M_WE	566	10	UNS162SW1M_GY	666	10
16A Master Switch, 2 Way, With Locator & Label	UNS162MSWL1M_WE	1315	20	UNS162MSWL1M_GY	1554	1
16Ax 2 Way 2M Switch	UNS162SW2M_WE	575	10	UNS162SW2M_GY	683	10
16AX~20A 1Way switch with Neon indicator	UNS201SWL1M_WE	505	10	UNS201SWL1M_GY	597	10
Double Pole Switches						
20A Double Pole Switch With Indicator	UNS20DP2M_WE	1017	10	UNS20DP2M_GY	1198	1
32A Double Pole Switch With Indicator	UNS32DP2M_WE	1513	10	UNS32DP2M_GY	1812	10
Motor Starter Switch						
Motor Starter	UNSMSTART2M_WE	2318	10	UNSMSTART2M_GY	2741	10
Bell Switches						
6A Bellpress, 1M	UNS6BP1M_WE	372	20	UNS6BP1M_GY	436	20
6A Bellpress With Indicator, 1M	UNS6BPL1M_WE	514	20	UNS6BPL1M_GY	615	1
6A Bellpress, 2M, Polar White	UNS6BP2M_WE	516	10	UNS6BP2M_GY	607	1
6A Bellpress With Indicator, 2M	UNS6BPL2M_WE	637	10	UNS6BPL2M_GY	748	1
6A Sockets						
6A 3PIN Sockets outlet with Shutter (BIS)	UNS6SK3P2MNS_WE	532	10	UNS6SK3P2MNS_GY	590	10
6A Switched Socket 2M	UNSSWSO62M_WE	751	10	UNSSWSO62M_GY	827	10
6/16A Sockets						
6/16A Socket	UNS616SK2M_WE	628	10	UNS616SK2M_GY	780	10
USB Chargers						
2.1A 5V USB Charger, 2 Module	UNS21USB2P2M_WE	3916	10	UNS21USB2P2M_GY	4628	1
2.1A 5V USB Charger, 1 Module	UNS21USB1P1M_WE	2692	20	UNS21USB1P1M_GY	3193	20
2.4A 5V A+C USB Charger, 1 Module	UNSACUSB1P1M_WE	4146	10	UNSACUSB1P1M_GY	4662	10
USB A+C 21W PDH 2M WE	UNSUSBAC2MPDH_WE	6262	10	UNSUSBAC2MPDH_GY	6889	10
Blank Plates						
Single Module Blank Plate	UNSBLANK1M_WE	91	20	UNSBLANK1M_GY	102	20
Fan Regulators						
4 Steps 360 Deg Fan Regulator, 1M	UNS4STFAN1M_WE	1106	20	UNS4STFAN1M_GY	1281	20
5 Steps 360 Deg Fan Regulator, 2M	UNS5STFAN2M_WE	1768	10	UNS5STFAN2M_GY	1996	10
Emergency Light Indicator						
Emergency Light Module*	UNSEMERGENCY2M_WE	14513	1	-	-	-
Network, Connectivity & Media Series						
RJ 11 (WITH Shutter)	UNSRJ11_1M_WE	359	20	UNSRJ11_1M_GY	423	20
RJ 45 (WITH Shutter), Cat 6	UNSRJ45_1M_WE	1308	20	UNSRJ45_1M_GY	1515	20
TV Socket Coaxial	UNSTVCOAX1M_WE	377	20	UNSTVCOAX1M_GY	446	20
Volume Control	UNSVOLCTRL2M_WE	3050	10	UNSVOLCTRL2M_GY	3637	10
HDMI	UNSHDMI_WE	2626	20	UNSHDMI_GY	2962	20
TV Socket Digital (F-Connector)	UNSCPTVDIG1M_WE	427	1	-	-	-
PIR Motion Sensor*	UNSPIR_WE	12481	4	-	-	-

Please contact Customer Care Center for Stockable and Non stockable status of references.
*Bold references are MTO reference.

Unica Pure - Irresistibly Beautiful



UNSEKCSW_WE



UNSCURTAINSW2M_WE



UNSSHAVER_WE



UNSPIR_WE



UNSSKTLT2M_WE



UNSPHASEG1M



UNSPHASER1M

Description	Reference for Polar White	Unit MRP [₹]	Pack	Reference for Volcanic Grey	Unit MRP [₹]	Pack
Hotel Series*						
Cord Outlet	UNSCORD1M_WE	510	20	UNSCORD1M_GY	567	20
DND / MMR Indicator*	UNSDM1M	9537	20	-	-	-
DND/MMR Indicator v.2	UNSDM1M_WE	2057	-	UNSDM1M_GY	2350	-
DND Switch	UNSDNDSW1M_WE	696	10	UNSDNDSW1M_GY	849	10
MMR Switch	UNSMMRSW1M_WE	696	10	UNSMMRSW1M_GY	849	10
SW DND MMR with interlock	UNSDNDMMRSW2M_WE	1160	10	UNSDNDMMRSW2M_GY	1390	10
Electronic Keycard Switch, White	UNSEKCSW_WE	9257	5	UNSEKCSW_GY	10700	5
Electronic Keycard Switch, Sandy Beige	UNSEKCSW_CL	9670	5	UNSEKCSW_CD	9541	5
Curtain Control Switch	UNSCURTAINSW2M_WE	1290	10	UNSCURTAINSW2M_GY	1495	10
Shaver Socket	UNSSHAVER_WE	9664	1	UNSSHAVER_GY	10540	1
Skirt Light with LED, 2M	UNSSKTLT2M_WE	1711	10	UNSSKTLT2M_GY	2003	10
Door Chime 230V AC 2M	UNSICHIME2M_WE	1747	-	UNSICHIME2M_GY	1916	-

Description	Reference	Unit MRP [₹]	Pack
LED Phase Indicator			
LED Phase Indicator, Red	UNSPHASER1M	629	20
LED Phase Indicator, Green	UNSPHASEG1M	629	20
LED Phase Indicator, Yellow	UNSPHASEY1M	629	20

Please contact Customer Care Center for Stockable and Non stockable status of references.
*Bold references are MTO reference.

Unica Pure - Irresistibly Beautiful



UNPGP2M



UNPGP6M

Description	Reference for Gridplate	Unit MRP [₹]	Pack
Cover Plates			
2 Module Gridplate (Fixing Frame) Only	UNPGP2M	210	4
3 Module Gridplate (Fixing Frame) Only	UNPGP3M	256	9
4 Module Gridplate (Fixing Frame) Only	UNPGP4M	295	8
6 Module Gridplate (Fixing Frame) Only	UNPGP6M	401	9
8 Module Gridplate (Fixing Frame) Only, Linear	UNPGP8ML	414	9
8 Module Gridplate (Fixing Frame) Only, Square	UNPGP8MSQ	529	6
12 Module Gridplate (Fixing Frame) Only	UNPGP12M	618	6



UNPSP2M_WD



UNPSP6M_WD

Description	Reference for Oak Wood	Unit MRP [₹]	Pack
Cover Plates			
1 Module Wood Cover Frame Only	UNPSP1M_WD	3043	6
2 Module Wood Cover Frame Only	UNPSP2M_WD	3234	6
3 Module Wood Cover Frame Only	UNPSP3M_WD	4003	6
4 Module Wood Cover Frame Only	UNPSP4M_WD	4632	6
6 Module Wood Cover Frame Only	UNPSP6M_WD	6610	3
8 Module Wood Cover Frame Only, Linear	UNPSP8ML_WD	8033	3
8 Module Wood Cover Frame Only, Square	UNPSP8MSQ_WD	9582	6
12 Module Wood Cover Frame Only	UNPSP12M_WD	12811	6



UNPSP2M_GW



UNPSP6M_GW



UNPSP2M_GB



UNPSP6M_GB

Description	Reference for Aqua Glass	Unit MRP [₹]	Pack	Reference for Pearl Black Glass	Unit MRP [₹]	Pack
Cover Plates						
1 Module Aqua Glass Cover Frame Only	UNPSP1M_GW	1682	6	UNPSP1M_GB	1992	6
2 Module Aqua Glass Cover Frame Only	UNPSP2M_GW	1892	6	UNPSP2M_GB	2240	6
3 Module Aqua Glass Cover Frame Only	UNPSP3M_GW	2131	6	UNPSP3M_GB	2435	6
4 Module Aqua Glass Cover Frame Only	UNPSP4M_GW	2227	6	UNPSP4M_GB	2640	6
6 Module Aqua Glass Cover Frame Only	UNPSP6M_GW	4023	3	UNPSP6M_GB	4658	3
8M Aqua Glass Cover Frame Only, Linear	UNPSP8ML_GW	4572	3	UNPSP8ML_GB	5385	3
8M Aqua Glass Cover Frame Only, Square	UNPSP8MSQ_GW	5790	6	UNPSP8MSQ_GB	6824	6
12 Module Aqua Glass Cover Frame Only	UNPSP12M_GW	7216	6	UNPSP12M_GB	8492	6

Please contact Customer Care Center for Stockable and Non stockable status of references.
*Bold references are MTO reference.

Unica Pure - Irresistibly Beautiful



UNPSP2M_ML



UNPSP6M_ML

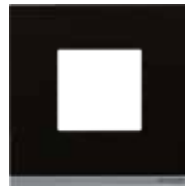

UNPSP2M_MD



UNPSP6M_MD

Description	Reference for Pewter Grey Metal	Unit MRP [₹]	Pack	Reference for Black Metal	Unit MRP [₹]	Pack
Cover Plates						
1 Module Pw Grey Metal Cover Frame Only	UNPSP1M_ML	3006	6	UNPSP1M_MD	3006	6
2 Module Pw Grey Metal Cover Frame Only	UNPSP2M_ML	3336	6	UNPSP2M_MD	3336	6
3 Module Pw Grey Metal Cover Frame Only	UNPSP3M_ML	3798	6	UNPSP3M_MD	3798	6
4 Module Pw Grey Metal Cover Frame Only	UNPSP4M_ML	3992	6	UNPSP4M_MD	3992	6
6 Module Pw Grey Metal Cover Frame Only	UNPSP6M_ML	7069	3	UNPSP6M_MD	7069	3
8Module Pw Grey Metal CF Only, Linear	UNPSP8ML_ML	7964	3	UNPSP8ML_MD	7964	3
8 Module Pw Grey Metal CF Only, Suare	UNPSP8MSQ_ML	10116	6	UNPSP8MSQ_MD	10116	6
12Module Pw Grey Metal Cover Frame Only	UNPSP12M_ML	12549	6	UNPSP12M_MD	12549	6



UNSCP2M_WE



UNSCP6M_WE



UNSCP2M_GY



UNSCP6M_GY



UNSCP2M_CD



UNSCP6M_CD



UNSCP2M_CL



UNSCP6M_CL

Description	Reference for Molded Polar White	Unit MRP [₹]	Pack	Reference for Molded Volcanic Grey	Unit MRP [₹]	Pack	Reference for Painted Mocha Brown	Unit MRP [₹]	Pack	Reference for Painted Sandy Biege	Unit MRP [₹]	Pack
Cover Plates												
1 Module Plastic Surround and Gridplate	UNSCP1M_WE	292	20	UNSCP1M_GY	415	20	UNSCP1M_CD	559	20	UNSCP1M_CL	569	20
2 Module Plastic Surround and Gridplate	UNSCP2M_WE	326	20	UNSCP2M_GY	465	20	UNSCP2M_CD	624	20	UNSCP2M_CL	645	20
3 Module Plastic Surround and Gridplate	UNSCP3M_WE	372	10	UNSCP3M_GY	529	10	UNSCP3M_CD	726	10	UNSCP3M_CL	724	10
4 Module Plastic Surround and Gridplate	UNSCP4M_WE	393	14	UNSCP4M_GY	566	14	UNSCP4M_CD	759	14	UNSCP4M_CL	759	14
6 Module Plastic Surround and Gridplate	UNSCP6M_WE	685	5	UNSCP6M_GY	977	5	UNSCP6M_CD	1307	5	UNSCP6M_CL	1352	5
8 Module Plastic Surround and Gridplate, Linear	UNSCP8ML_WE	771	5	UNSCP8ML_GY	1091	5	UNSCP8ML_CD	1475	5	UNSCP8ML_CL	1502	5
8 Module Plastic Surround and Gridplate, Square	UNSCP8MSQ_WE	997	10	UNSCP8MSQ_GY	1512	10	UNSCP8MSQ_CD	1866	10	UNSCP8MSQ_CL	1866	5
9 Module Plastic Surround and Gridplate	UNSCP9M_WE	1252	5	UNSCP9M_GY	1954	5	-	-	-	-	-	
12 Module Plastic Surround and Gridplate	UNSCP12M_WE	1394	5	UNSCP12M_GY	2451	5	UNSCP12M_CD	2359	5	UNSCP12M_CL	2355	5
16 Module Plastic Surround and Gridplate	UNSCP16M_WE	1715	5	UNSCP16M_GY	2959	5	UNSCP16M_CD	3193	5	UNSCP16M_CL	3193	5
18 Module Plastic Surround and Gridplate	UNSCP18M_WE	1778	1	UNSCP18M_GY	3159	1	UNSCP18M_CD	3422	1	UNSCP18M_CL	3422	1

Please contact Customer Care Center for Stockable and Non stockable status of references.

*Bold references are MTO reference.

Wiring Diagram Unica Pure

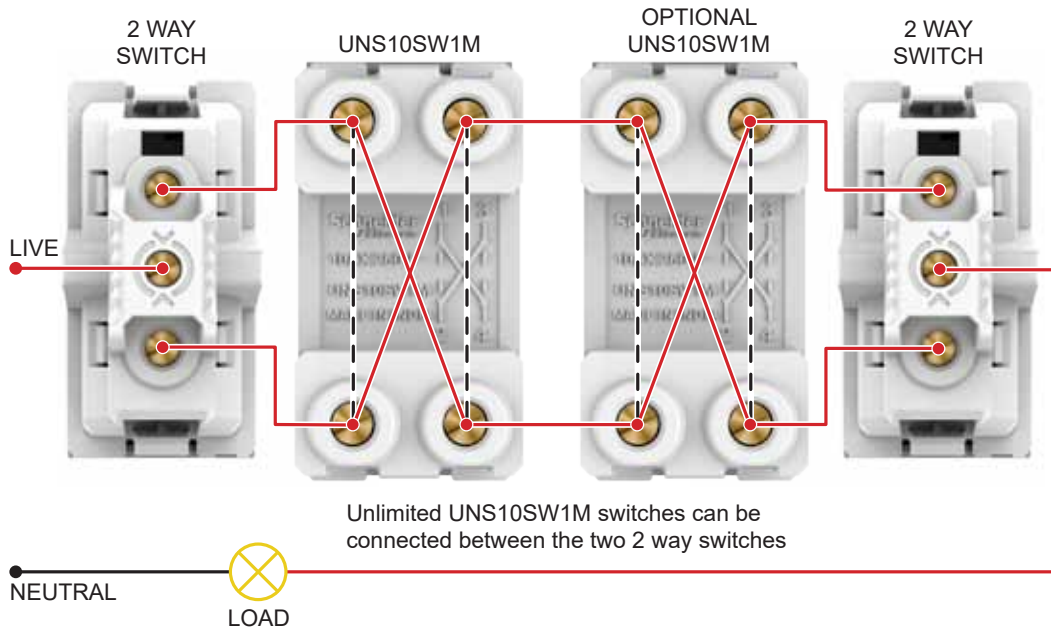

> 10AX Intermediate Switch

UNS10SW1M_WE, UNS10SW1M_GY

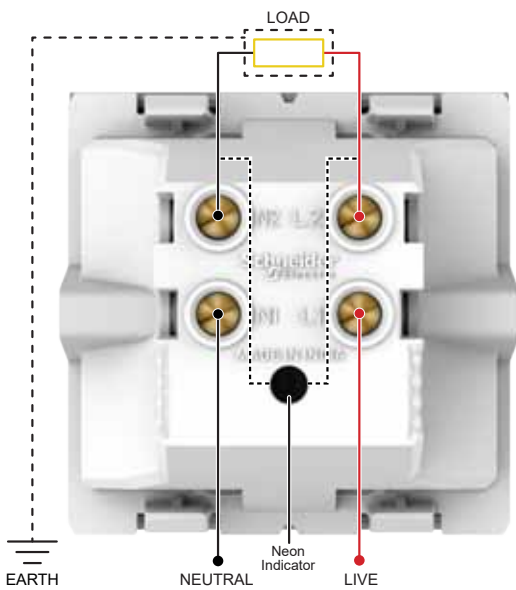

> 20A Double Pole Switch With Indicator

UNS20DP2M_WE, UNS20DP2M_GY

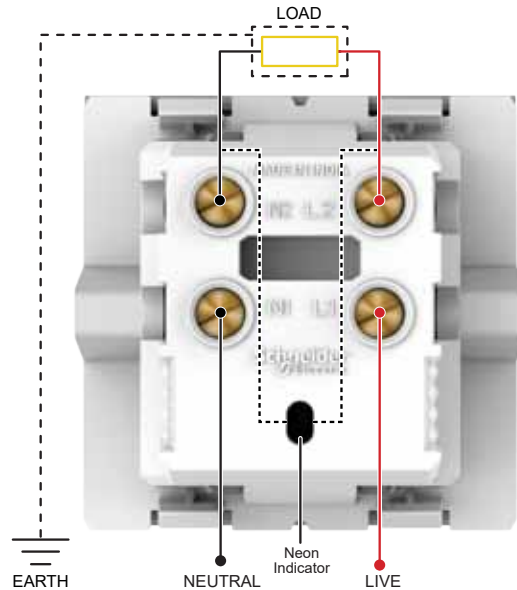

> 32A Double Pole Switch With Indicator

UNS32DP2M_WE, UNS32DP2M_GY

Wiring Diagram Unica Pure

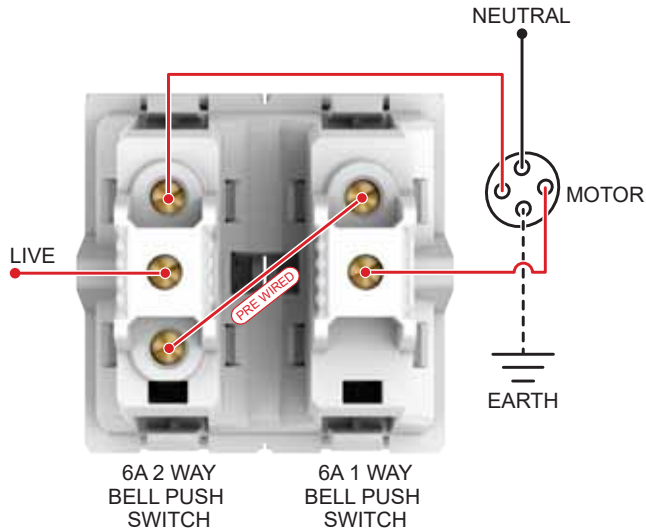

> Curtain Control Switch
UNSCURTAINSW2M_WE

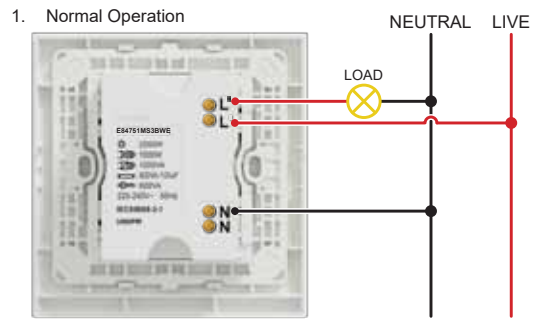

> PIR Motion Sensor*
UNSPIR_WE

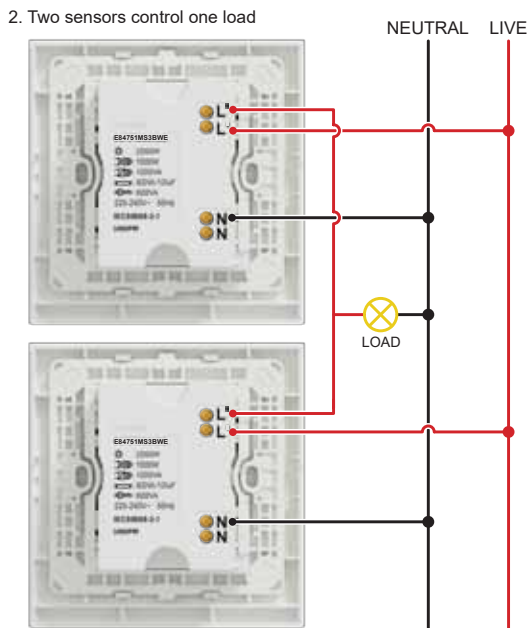

> PIR Motion Sensor*
UNSPIR_WE

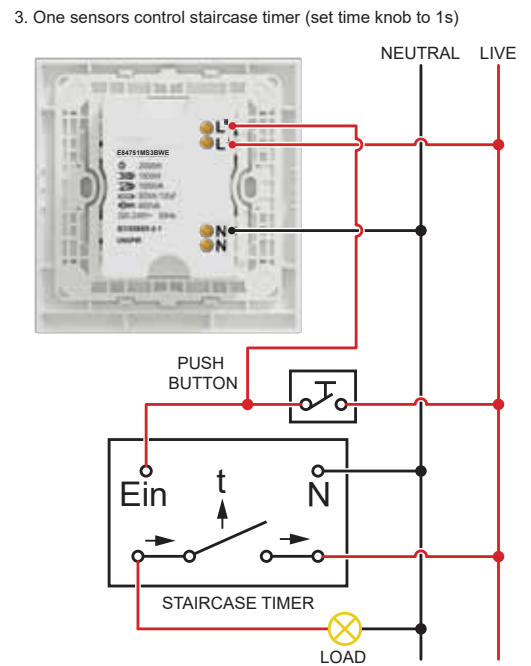

> PIR Motion Sensor*
UNSPIR_WE

Wiring Diagram Unica Pure

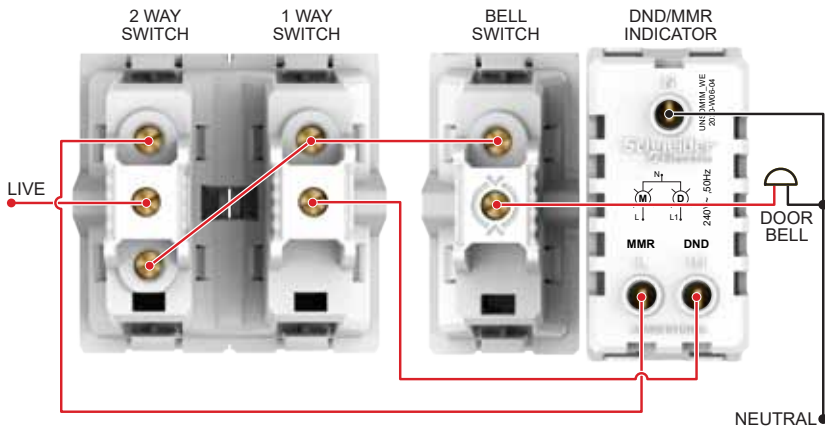

- > DND/MMR Indicator v.2
- > Do Not Disturb Switch
- > Make My Room Switch
- > DND Switch
- > MMR Switch

UNSDM1M_WE, UNSDM1M_GY, UNSDNDSW1M_WE,
UNSDNDSW1M_GY, UNSMMSW1M_WE, UNSMMSW1M_GY

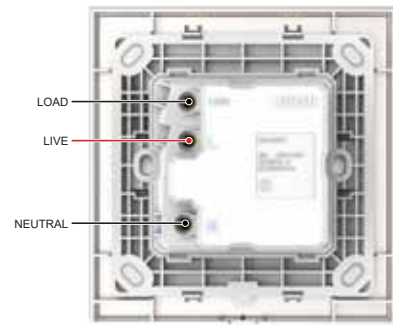

- > Unica Pure Key Card

UNSEKCSW_WE, UNSEKCSW_GY,
UNSEKCSW_CL, UNSEKCSW_CD

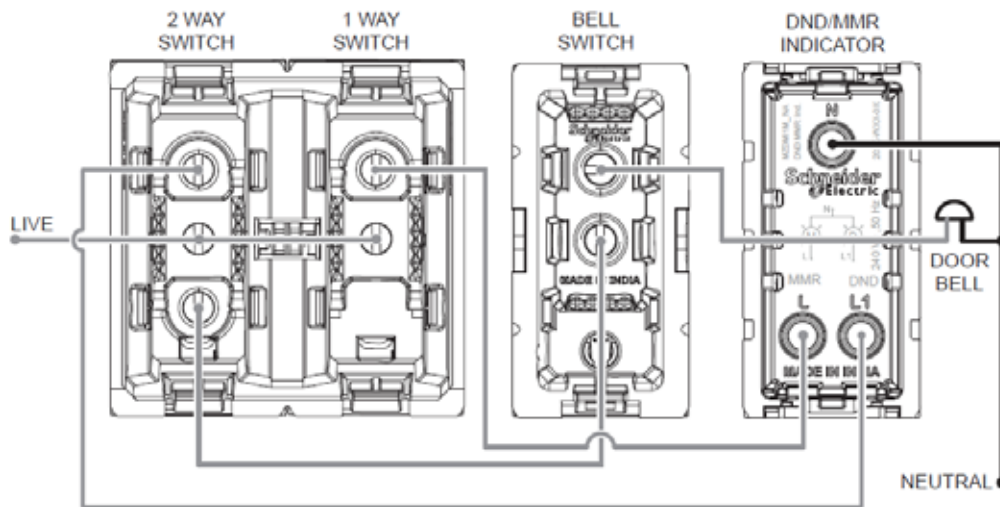

- > SW DNDMMR with interlock

UNSDNDMMRSW2M_WE & UNSDNDMMRSW2M_GY

ZENcelo India - The Revolutionary Full-Flat Switch



- **World's First and only Full-Flat Mechanical Switch**
- **Patented Iso-Motion Technology** - Ensures switch stays in the same position whether On or Off
- **Robust & Strong** - Made of corrosion-resistant, heat-resistant and impact-resistant polycarbonate
- **Safe to Use** - Electric arc encapsulated switches and Data Sockets with patented integrated shutter
- **Designed to Last** - Switches tested to 80,000 times; Sockets tested to 15,000 cycles.
- **Green & Eco Friendly** - RoHS compliant range
- **Dust Proof Cover**
- **All Dark Grey references covered with electrostatic protective film**
- **Intermediate switches to control multiple 2way switches**
- **16AX~20A 1 Way 2G Switch (1M) - IN8444/16: Single switch to control two loads**



Description	Reference for White	Unit MRP [₹]	Pack	Reference for Dark Grey	Unit MRP [₹]	Pack
Switches						
6AX 1 Way switch	IN8401	496	10	IN8401(BZ)	621	10
6AX 1 Way switch (2M)	IN8421	891	10	IN8421(BZ)	1054	10
6AX 2 Way switch	IN8402	621	10	IN8402(BZ)	747	10
6AX 1 Way switch with Neon	IN8481	797	10	IN8481(BZ)	954	10
16AX~20A 1 Way switch	IN8401/16	758	10	IN8401/16(BZ)	922	10
16AX~20A 1 Way switch (2M)	IN8421/16	1178	10	-	-	-
16AX~20A 1 Way switch with Neon	IN8481/16	1087	10	IN8481/16(BZ)	1288	10
16AX~20A 1 Way switch with Neon (2M)	IN8482/16	1392	10	IN8482/16(BZ)	1654	10
16AX~20A 2 Way switch	IN8402/16	1075	10	IN8402/16(BZ)	1394	10
16AX~20A 2 Way switch (2M)	IN8422/16	1288	10	IN8422/16(BZ)	1661	10
16AX~20A 1 Way 2G switch (1M)	IN8444/16	1238	10	IN8444/16(BZ)	1507	10
10AX Intermediate switch	IN8430/IM	2054	10	-	-	-
6A Momentary Switch	IN8487	1015	10	IN8487_BZ	1198	-
20A DP Switch with Neon (2M)	IN8486/20	1658	5	IN8486/20(BZ)	2252	5
32A DP Switch with Neon (2M)	IN8486/32	2581	5	IN8486/32(BZ)	3216	5
Motor Starter Switch						
25A Motor Starter switch (2M)	IN8425MS	4403	10	IN8425MS(BZ)	4707	10
Bell Push						
6A Bell Push switch	IN8405	705	10	IN8405(BZ)	887	10
6A Bell Push switch (2M)	IN8425	1145	10	IN8425(BZ)	1413	10
6A Bell Push switch with Neon	IN8485	1035	10	IN8485(BZ)	1219	10
6A Bell Push switch with Neon (2M)	IN8486	1211	10	IN8486(BZ)	1555	10
Sockets						
6A 3 PIN Socket Outlet with Shutter (BIS)	IN8426UNS	819	10	IN8426UNS_BZ	992	10
6A/16A 3 Pin Socket with Shutter	IN8426/16	1219	10	IN8426/16(BZ)	1493	10
Fan Regulators & Dimmers						
Fan Control (5 Speeds)	IN84SFR	3036	5	IN84SFR(BZ)	3644	5
Full Flat 500W Dimmer Module (1 Gang)	IN8404D	2758	10	IN8404D(BZ)	3267	10
USB Chargers						
1 Gang USB Charger - 2.1A (1M)	IN8431USB_WE	4723	10	IN8431USB_BZ	5419	10
2.4A 5V A+C USB Charger (1M)	IN8431ACUSB_WE	5222	10	IN8431ACUSB_BZ	5985	10
Accessories						
RJ11 Telephone Outlet with shutter (1 Gang)	IN8431RJS4	814	10	IN8431RJS4(BZ)	1002	10
RJ45 Cat6 Data Outlet with shutter	IN8431RJ6	2875	10	IN8431RJ6(BZ)	3511	10
TV Socket	IN8431TV	622	10	IN8431TV(BZ)	800	10
Foot Lamp with White LED (2M)	IN8490FLW	5847	10	-	-	-
Foot Lamp with Yellow LED (2M)	IN8490FLY	5702	10	-	-	-
Blank off unit (1M)	IN8430X	185	10	IN8430X(BZ)	228	10
Door Chime 230VAC 2M	INCHIME8488	2822	-	INCHIME8488_BZ	3157	-
Hotel Series						
Do Not Disturb Panel	INH8451	4515	10	INH8451(BZ)	5104	10
Make My Room Panel	INH8454	4220	10	INH8454(BZ)	4710	10
Do Not Disturb Switch	INH8452	2241	10	INH8452(BZ)	2474	10
Do Not Disturb Switch (2M)	-	-	-	INH8453(BZ)	2774	10
Make My Room Switch	INH8455	2190	10	INH8455(BZ)	2608	10

Please contact Customer Care Center for Stockable and Non stockable status of references.
*Bold references are MTO reference.

ZENcelo India - The Revolutionary Full-Flat Switch



IN8403C



IN8406C



IN8402C(BZ)

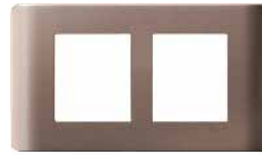

IN8404C(SZ)



IN84012C(SA)

Description	Reference for White	Unit MRP [₹]	Pack	Reference for Dark Grey	Unit MRP [₹]	Pack	Reference for Silver Bronze	Unit MRP [₹]	Pack	Reference for Satin Silver	Unit MRP [₹]	Pack
Cover Plates												
1M Grid & 1M Cover Frame	IN8401C	488	10	IN8401C(BZ)	606	10	IN8401C(SZ)	1424	10	IN8401C(SA)	1563	10
2M Grid & 2M Cover Frame	IN8402C	512	10	IN8402C(BZ)	636	10	IN8402C(SZ)	1410	10	IN8402C(SA)	1546	10
3M Grid & 3M Cover Frame	IN8403C	602	10	IN8403C(BZ)	750	10	IN8403C(SZ)	1733	10	IN8403C(SA)	1901	10
4M Grid & 4M Cover Frame	IN8404C	657	10	IN8404C(BZ)	881	10	IN8404C(SZ)	2082	10	IN8404C(SA)	2286	10
6M Grid & 6M Cover Frame	IN8406C	1002	5	IN8406C(BZ)	1251	5	IN8406C(SZ)	2859	5	IN8406C(SA)	3167	5
8M Grid & 8M Cover Frame - Horizontal	IN8408HC	1202	5	IN8408HC(BZ)	1496	5	IN8408HC(SZ)	3899	5	IN8408HC(SA)	4279	5
8M Grid & 8M Cover Frame - Square	IN8408SC	1603	5	IN8408SC(BZ)	2307	5	-	-	-	IN8408SC(SA)	5195	5
9M Grid & 9M Cover Frame	IN8409C	2207	5	-	-	-	IN8409C(SZ)	6546	5	-	-	-
12M Grid & 12M Cover Frame	IN84012C	2659	5	IN84012C(BZ)	3407	5	IN84012C(SZ)	8803	5	IN84012C(SA)	9661	5
18M Grid & 18M Cover Frame	IN84018C	3750	5	IN84018C(BZ)	5043	5	IN84018C(SZ)	11651	5	IN84018C(SA)	12789	5

Please contact Customer Care Center for Stockable and Non stockable status of references.
*Bold references are MTO reference.

Wiring Diagram ZENcelo

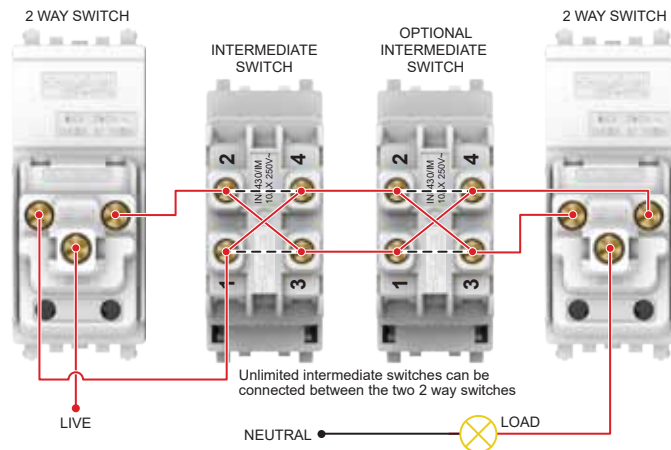

> 10AX Intermediate Switch

IN8430/IM, IN8430/IM (BZ)

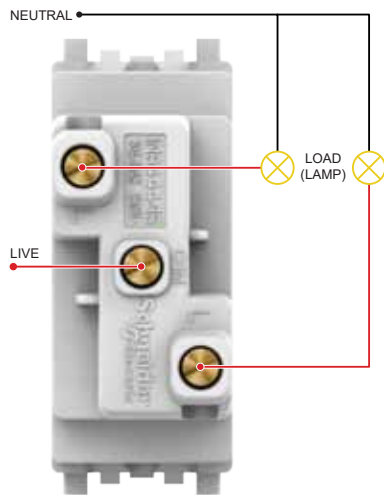

> 16AX~20A 1 Way 2G Switch (1M)

IN8444/16, IN8444/16 (BZ)

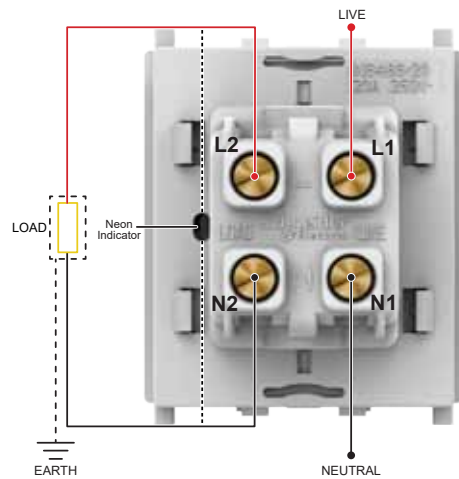

> 20A DP Switch with Neon (2M)

IN8486/20, IN8486/20 (BZ)

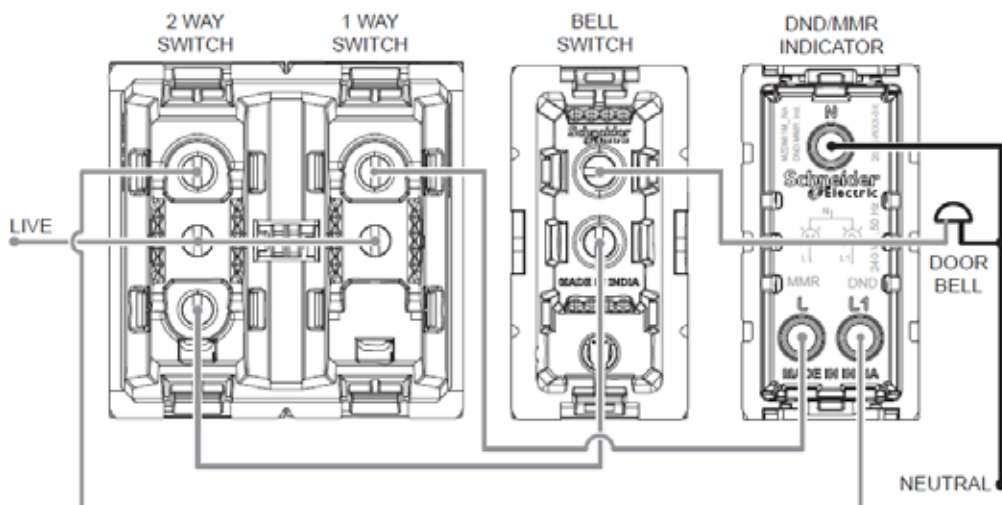

> SW DNDMMR White with interlock 2M

INH8456_WE & INH8456_BZ

Wiring Diagram ZENcelo

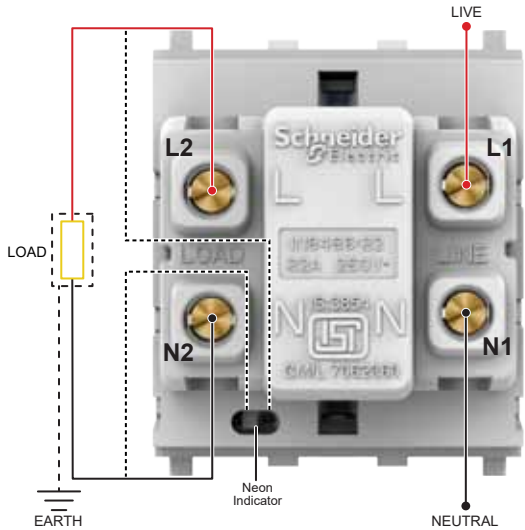

> 32A DP Switch with Neon (2M)

IN8486/32, IN8486/32 (BZ)

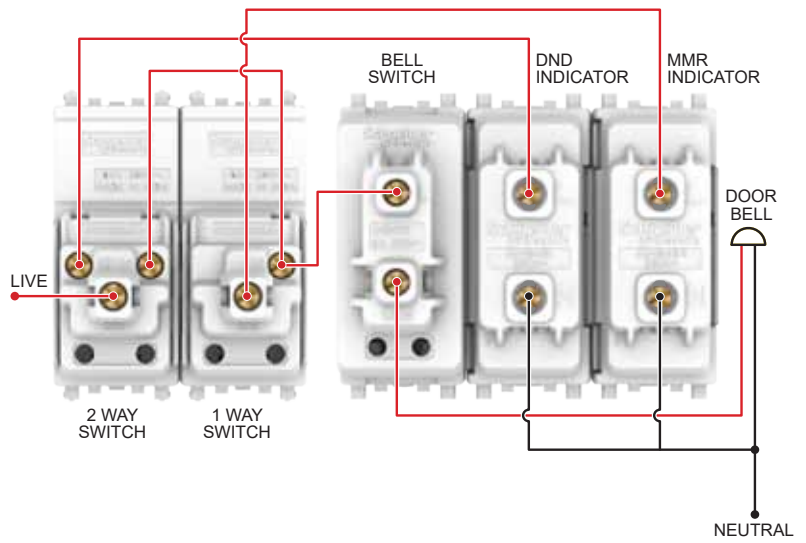

> Do Not Disturb Panel > Make My Room Panel
> Do Not Disturb Switch > Make My Room Switch

INH8451, INH8451 (BZ), INH8454, INH8454 (BZ),
INH8452, INH8452 (BZ), INH8455, INH8455 (BZ)

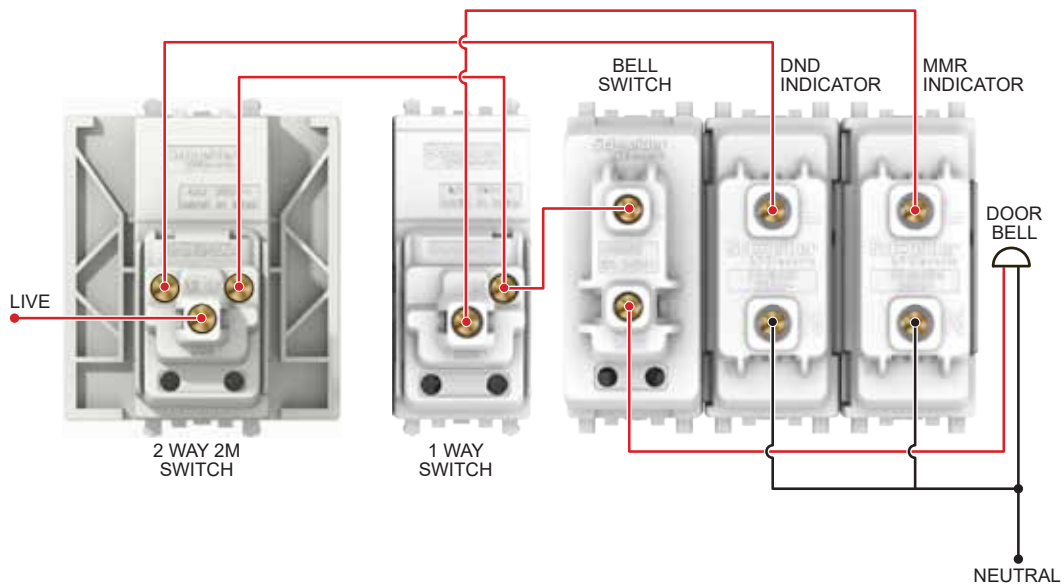

> Do Not Disturb Panel > Make My Room Panel
> Do Not Disturb Switch (2M) > Make My Room Switch

INH8451, INH8451 (BZ), INH8454, INH8454 (BZ)
INH8453 (BZ), INH8455, INH8455 (BZ)

AvatarOn - It's also a Switch



White (WE)



Wine Gold (WG)



Dark Grey (DG)



Dark Wood (WD)



Gold Hairline (GH)



Light Wood (LW)



Award-winning Designs: In 2017, AvatarOn gained international recognition for its innovative design and quality excellence and was awarded the iF Design Award

Ingenious Beauty

- The ground-breaking AvatarOn series is a true marriage of aesthetics and practicality, making it a perfect choice for all home or office designs.

Safe and Reliable

- Our patented "Slim Rocker, Sure Click" SS technology not only gives AvatarOn a greater thinness overall, but also a near-zero contact jitter that reduces sparks, thus ensuring a safe and reliable use.

Customisable Covers for True Adaptability

- AvatarOn switches are available in an array of replaceable covers for full customisation and integration into any home decor. The customised pattern covers of AvatarOn provides you with an extra canvas to showcase your creativity in a subtle yet apparent way.

Modern Look

- The stylish and streamlined design of AvatarOn switch covers are finished in white, soft wood, dark wood and gold hairline materials for a classic look and universal elegance.

Tech-chic Design that Shines

- The AvatarOn soft LED locators merges seamlessly with its sleek giant dolly, creating a stylish and streamlined design and glow with a soft luminescent in the dark, indicating the exact location of each switch at night.















Multifunctional Accessories for Every Day Conveniences

Product Description	Color	Product Ref. No.	Unit MRP [₹]	Pack
16A Switches (Base + Cover Plate)				
16AX 250V 1 Gang 1 Way Switch	White	E8331L1_WE_G8	726	1
	Wine Gold	E8331L1_WG_G8	1091	10
	Dark Grey	E8331L1_DG_G8	1091	1
	Metal Gold Hairline	E8331L1_GH_G8	1095	10
	Light Wood	E8331L1_LW_G8	1181	10
	Dark Wood	E8331L1_WD_G8	1095	10
16AX 250V 1 Gang 1 Way Switch with LED Indicator	White	E8331L1LED_WE_G8	1091	1
	Wine Gold	E8331L1LED_WG_G8	1631	10
	Dark Grey	E8331L1LED_DG_G8	1631	1
	Metal Gold Hairline	E8331L1LED_GH_G8	1639	10
	Light Wood	E8331L1LED_LW_G8	1926	10
	Dark Wood	E8331L1LED_WD_G8	1639	10
16AX 250V 1 Gang 2 Way Switch	White	E8331L2_WE_G8	750	1
	Wine Gold	E8331L2_WG_G8	1164	10
	Dark Grey	E8331L2_DG_G8	1164	1
	Metal Gold Hairline	E8331L2_GH_G8	1169	10
	Light Wood	E8331L2_LW_G8	1260	10
	Dark Wood	E8331L2_WD_G8	1169	10
16AX 250V 1 Gang 2 Way Switch with LED Indicator	White	E8331L2LED_WE_G8	1164	10
	Wine Gold	E8331L2LED_WG_G8	1747	10
	Dark Grey	E8331L2LED_DG_G8	1747	1
	Metal Gold Hairline	E8331L2LED_GH_G8	1756	10
	Light Wood	E8331L2LED_LW_G8	2064	10
	Dark Wood	E8331L2LED_WD_G8	1987	10
16AX 250V 2 Gang 1 Way Switch	White	E8332L1_WE_G8	1132	1
	Wine Gold	E8332L1_WG_G8	1699	10
	Dark Grey	E8332L1_DG_G8	1699	1
	Metal Gold Hairline	E8332L1_GH_G8	1715	10
	Light Wood	E8332L1_LW_G8	1789	10
	Dark Wood	E8332L1_WD_G8	1715	10
16AX 250V 2 Gang 1 Way Switch with LED Indicator	White	E8332L1LED_WE_G8	1699	1
	Wine Gold	E8332L1LED_WG_G8	2550	10
	Dark Grey	E8332L1LED_DG_G8	2550	1
	Metal Gold Hairline	E8332L1LED_GH_G8	2575	10
	Light Wood	E8332L1LED_LW_G8	3039	10
	Dark Wood	E8332L1LED_WD_G8	2575	10
16AX 250V 2 Gang 2 Way Switch	White	E8332L2_WE_G8	1378	1
	Wine Gold	E8332L2_WG_G8	2067	10
	Dark Grey	E8332L2_DG_G8	2067	1
	Metal Gold Hairline	E8332L2_GH_G8	2086	10
	Light Wood	E8332L2_LW_G8	2463	10
	Dark Wood	E8332L2_WD_G8	2086	10

Please contact Customer Care Center for Stockable and Non stockable status of references.

*Bold references are MTO reference.

AvatarOn - It's also a Switch

		Product Description	Color	Product Ref. No.	Unit MRP [₹]	Pack
16A Switches (Base + Cover Plate)						
	E8332L2LED_WE_G8	16AX 250V 2 Gang 2 Way Switch with LED Indicator	White	E8332L2LED_WE_G8	2067	10
			Wine Gold	E8332L2LED_WG_G8	3102	10
			Dark Grey	E8332L2LED_DG_G8	3102	1
			Dark Wood	E8332L2LED_WD_G8	3132	10
	E8332L2LED_WD_G8	16AX 250V 2 Gang 2 Way Switch with LED Indicator	White	E8333L1_WE_G8	1867	1
			Wine Gold	E8333L1_WG_G8	2801	10
			Dark Grey	E8333L1_DG_G8	2854	1
			Metal Gold Hairline	E8333L1_GH_G8	2841	10
	E8333L1LED_WE_G8	16AX 250V 3 gang 1 Way Switch	Light Wood	E8333L1_LW_G8	2935	10
			Dark Wood	E8333L1_WD_G8	2841	10
			White	E8333L1LED_WE_G8	2801	10
			Wine Gold	E8333L1LED_WG_G8	4199	10
	E8333L1LED_WD_G8	16AX 250V 3 gang 1 Way Switch	Dark Grey	E8333L1LED_DG_G8	4199	1
			Metal Gold Hairline	E8333L1LED_GH_G8	4259	10
			Light Wood	E8333L1LED_LW_G8	4981	10
			Dark Wood	E8333L1LED_WD_G8	4259	10
	E8333L2_WE_G8	16AX 250V 3 gang 1 Way Switch with LED Indicator	White	E8333L2_WE_G8	2009	1
			Wine Gold	E8333L2_WG_G8	3015	10
			Dark Grey	E8333L2_DG_G8	3015	1
			Metal Gold Hairline	E8333L2_GH_G8	3059	10
	E8333L2_WD_G8	16AX 250V 3 gang 1 Way Switch with LED Indicator	Dark Wood	E8333L2_WD_G8	3059	10
			White	E8333L2LED_WE_G8	3015	10
			Wine Gold	E8333L2LED_WG_G8	4522	10
			Dark Grey	E8333L2LED_DG_G8	4522	1
	E8333L2LED_WE_G8	16AX 250V 3 gang 2 Way Switch with LED Indicator	Metal Gold Hairline	E8333L2LED_GH_G8	4587	10
			Light Wood	E8333L2LED_LW_G8	5119	10
			Dark Wood	E8333L2LED_WD_G8	4587	10
			White	E8334L1_WE_G8	2685	1
	E8333L2LED_WD_G8	16AX 250V 3 gang 2 Way Switch with LED Indicator	Wine Gold	E8334L1_WG_G8	4030	10
			Dark Grey	E8334L1_DG_G8	4030	1
			Metal Gold Hairline	E8334L1_GH_G8	4086	10
			Light Wood	E8334L1_LW_G8	4222	10
	E8334L1_WE_G8	16AX 250V 4 Gang 1 Way Switch	Dark Wood	E8334L1_WD_G8	4086	10
			White	E8334L1LED_WE_G8	4030	10
			Wine Gold	E8334L1LED_WG_G8	6042	10
			Dark Grey	E8334L1LED_DG_G8	6042	1
	E8334L1_WD_G8	16AX 250V 4 Gang 1 Way Switch	Metal Gold Hairline	E8334L1LED_GH_G8	6129	10
			Light Wood	E8334L1LED_LW_G8	7167	10
			Dark Wood	E8334L1LED_WD_G8	6129	10
			White	E8334L2_WE_G8	3089	1
	E8334L1LED_WE_G8	16AX 250V 4 Gang 1 Way Switch with LED Indicator	Wine Gold	E8334L2_WG_G8	4631	10
			Dark Grey	E8334L2_DG_G8	4720	1
			Metal Gold Hairline	E8334L2_GH_G8	4699	10
			Dark Wood	E8334L2_WD_G8	4699	10
	E8334L1LED_WD_G8	16AX 250V 4 Gang 1 Way Switch with LED Indicator	White	E8334L2LED_WE_G8	4631	10
			Wine Gold	E8334L2LED_WG_G8	6949	10
			Dark Grey	E8334L2LED_DG_G8	6949	1
			Metal Gold Hairline	E8334L2LED_GH_G8	7048	10
	E8334L2_WE_G8	16AX 250V 4 Gang 2 Way Switch	White	E8334L2_WE_G8	3089	1
			Wine Gold	E8334L2_WG_G8	4631	10
			Dark Grey	E8334L2_DG_G8	4720	1
			Metal Gold Hairline	E8334L2_GH_G8	4699	10
	E8334L2_WD_G8	16AX 250V 4 Gang 2 Way Switch	Dark Wood	E8334L2_WD_G8	4699	10
			White	E8334L2LED_WE_G8	4631	10
			Wine Gold	E8334L2LED_WG_G8	6949	10
			Dark Grey	E8334L2LED_DG_G8	6949	1
	E8334L2LED_WE_G8	16AX 250V 4 Gang 2 Way Switch with LED Indicator	Metal Gold Hairline	E8334L2LED_GH_G8	7048	10

Please contact Customer Care Center for Stockable and Non stockable status of references.
*Bold references are MTO reference.

AvatarOn - It's also a Switch



E8331M_WE_G8



E8331PRL1_WD_G8



E8332PRL1_WE_G8



E8332PRL1_WD_G8



E8331D20N_WE_G8



E8331D20N_WD_G8



E8331D32N_WE_G8



E8332D20N_WD_G8



E8331D32N_WD_G8







E8331D45N_WD_G8

Product Description	Color	Product Ref. No.	Unit MRP ₹	Pack
16A Intermediate Switches				
16AX 250V 1 Gang Intermediate Switch	White	E8331M_WE_G8	2497	1
	Wine Gold	E8331M_WG_G8	3746	1
	Dark Grey	E8331M_DG_G8	3746	1
10A Momentary Switches				
10A 250V 1 Gang Momentary Switch	Dark Wood	E8331PRL1_WD_G8	1335	10
	White	E8332PRL1_WE_G8	1121	10
	Wine Gold	E8332PRL1_WG_G8	1678	10
	Dark Grey	E8332PRL1_DG_G8	1678	1
	Metal Gold Hairline	E8332PRL1_GH_G8	1678	10
10A 250V 2 Gang Momentary Switch	Dark Wood	E8332PRL1_WD_G8	1678	10
	Dark Wood	E8332PRL1_WD_G8	1678	10
Double Pole Switches				
20A 250V 1 Gang Double Pole Switch with LED Indicator	White	E8331D20N_WE_G8	1922	10
	Wine Gold	E8331D20N_WG_G8	2878	10
	Dark Grey	E8331D20N_DG_G8	2878	1
	Metal Gold Hairline	E8331D20N_GH_G8	2906	10
	Light Wood	E8331D20N_LW_G8	2827	10
	Dark Wood	E8331D20N_WD_G8	2906	10
20A 250V 2 Gang Double Pole Switch with LED Indicator	White	E8332D20N_WE_G8	2446	10
	Wine Gold	E8332D20N_WG_G8	3455	10
	Dark Grey	E8332D20N_DG_G8	3455	1
	Metal Gold Hairline	E8332D20N_GH_G8	3488	10
	Dark Wood	E8332D20N_WD_G8	3488	10
32A 250V 1 Gang Double Pole Switch with LED Indicator	White	E8331D32N_WE_G8	2549	10
	Wine Gold	E8331D32N_WG_G8	3822	10
	Dark Grey	E8331D32N_DG_G8	3822	1
	Metal Gold Hairline	E8331D32N_GH_G8	3858	10
	Light Wood	E8331D32N_LW_G8	3858	10
	Dark Wood	E8331D32N_WD_G8	3858	10
45A 250V 1 Gang Double Pole Switch with LED Indicator	Wine Gold	E8331D45N_WG_G8	4779	10
	Dark Grey	E8331D45N_DG_G8	4865	1
	Metal Gold Hairline	E8331D45N_GH_G8	4912	10
	Dark Wood	E8331D45N_WD_G8	4604	10

Please contact Customer Care Center for Stockable and Non stockable status of references.
*Bold references are MTO reference.

AvatarOn - It's also a Switch

		Product Description	Color	Product Ref. No.	Unit MRP ₹	Pack
Bell Push Switch						
 E8331BPL1_WE_G8	 E8331BPL1_WD_G8	10A 250V Door Bell Push Switch	White	E8331BPL1_WE_G8	813	1
			Wine Gold	E8331BPL1_WG_G8	1223	10
			Dark Grey	E8331BPL1_DG_G8	1217	1
			Metal Gold Hairline	E8331BPL1_GH_G8	1235	10
			Light Wood	E8331BPL1_LW_G8	1246	10
			Dark Wood	E8331BPL1_WD_G8	1235	10
Sockets						
 E8315_6_NS_WE	 E8315_6_NS_WD	6A 2/3 Pin Switched Socket	White	E8315_6_NS_WE	1619	8
			Wine Gold	E8315_6_NS_WG	2097	8
			Dark Grey	E8315_6_NS_DG	2058	1
			Metal Gold Hairline	E8315_6_NS_GH	2078	8
			Light Wood	E8315_6_NS_LW	2157	8
			Dark Wood	E8315_6_NS_WD	2078	8
 E8331FR350_WE_G8	 E8331FR350_WD_G8	6/16A Switched Socket	White	E8315_16_WE	2031	8
			Wine Gold	E8315_16_WG	2583	8
			Dark Grey	E8315_16_DG	2583	1
			Metal Gold Hairline	E8315_16_GH	2657	8
			Light Wood	E8315_16_LW	2707	8
			Dark Wood	E8315_16_WD	2608	8
Fan Regulators						
 E8331_WE	 E8331_WD	5 Steps 360 Deg Fan Regulator	White	E8331FR350_WE_G8	3857	1
			Wine Gold	E8331FR350_WG_G8	5084	1
			Dark Grey	E8331FR350_DG_G8	5084	1
			Metal Gold Hairline	E8331FR350_GH_G8	5084	1
			Light Wood	E8331FR350_LW_G8	5425	1
			Dark Wood	E8331FR350_WD_G8	5084	1
Switch & Socket Covers (Additional)						
 E8331_WE	 E8331_WD	1 Gang Switch Cover	White	E8331_WE	221	1
			Wine Gold	E8331_WG	611	1
			Metal Gold Hairline	E8331_GH	890	1
			Dark Wood	E8331_WD	611	1
 E8331KH_WE	 E8332_WD	1 Gang Switch Cover with Keyholder	White	E8331KH_WE	526	1
			Dark Wood	E8332_WD		
 E8332_WE	 E8333_WE	2 Gang Switch Cover	White	E8332_WE	333	1
			Wine Gold	E8332_WG	834	1
			Metal Gold Hairline	E8332_GH	834	1
			Light Wood	E8332_LW	857	1
			Dark Wood	E8332_WD	834	1
 E8332_WE	 E8333_WE	3 Gang Switch Cover	White	E8333_WE	515	1
			Wine Gold	E8333_WG	1226	1
			Metal Gold Hairline	E8333_GH	1226	1
			Light Wood	E8333_LW	1203	1

Please contact Customer Care Center for Stockable and Non stockable status of references.
 *Bold references are MTO reference.

AvatarOn - It's also a Switch



E8334_WE



E8334_WD



E8315C_6_NC_WE



E8315C_6_NC_WD



E8332USB_WE_G8



E8315C_16_WD



E8332ACQUSB_WE



E8332USB_WD_G8



E8331_26_WE



E8331_36_WE

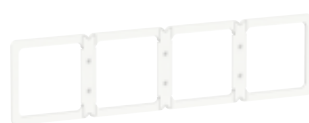

E8331_46_WE



E8330TX_WE

Product Description	Color	Product Ref. No.	Unit MRP ₹	Pack
4G Switch Cover	White	E8334_WE	805	1
	Wine Gold	E8334_WG	1504	1
	Dark Grey	E8334_DG	1437	1
	Metal Gold Hairline	E8334_GH	1671	1
	Light Wood	E8334_LW	1642	1
	Dark Wood	E8334_WD	1504	1
6A 2/3 Pin Switched Socket Cover	White	E8315C_6_NC_WE	575	12
	Wine Gold	E8315C_6_NC_WG	974	12
	Dark Grey	E8315C_6_NC_DG	974	1
	Metal Gold Hairline	E8315C_6_NC_GH	974	12
	Light Wood	E8315C_6_NC_LW	1125	12
	Dark Wood	E8315C_6_NC_WD	974	12
	16A 2/3 Pin Switched Socket Cover	Wine Gold	E8315C_16_WG	1019
Dark Grey		E8315C_16_DG	1019	1
Metal Gold Hairline		E8315C_16_GH	1131	12
Light Wood		E8315C_16_LW	1122	12
Dark Wood		E8315C_16_WD	1131	12
USB Chargers				
2 x 2.1A USB Charger with Mobile Holder (2.1A with 2 outputs used simultaneously)	White	E8332USB_WE_G8	9670	1
	Wine Gold	E8332USB_WG_G8	14507	1
	Dark Grey	E8332USB_DG_G8	14507	1
	Metal Gold Hairline	E8332USB_GH_G8	14507	1
	Light Wood	E8332USB_LW_G8	17193	1
	Dark Wood	E8332USB_WD_G8	14507	1
	Metal Gold Hairline	E8332ACQUSB_GH	8802	-
21W Type A+C, PD+QC3.0 USB Charger	Light Wood	E8332ACQUSB_LW	9434	-
	Dark Wood	E8332ACQUSB_WD	8802	-
	White	E8332ACQUSB_WE	7115	-
	Wine Gold	E8332ACQUSB_WG	8802	-
Bracket/Frame (to ensure alignment of switches on 2/3/4 Gang metal box)				
2 Gang Bracket/Frame	White	E8331_26_WE	365	1
	Wine Gold	E8331_26_WG	478	1
	Dark Grey	E8331_26_DG	455	1
3 Gang Bracket/Frame	White	E8331_36_WE	402	1
	Wine Gold	E8331_36_WG	563	1
	Dark Grey	E8331_36_DG	537	1
4 Gang Bracket/ Frame	White	E8331_46_WE	429	1
	Wine Gold	E8331_46_WG	604	1
	Dark Grey	E8331_46_DG	576	1
Blank Plates				
1 Gang Blank Plate	White	E8330X_WE	490	1
	Wine Gold	E8330X_WG	737	1
	Dark Grey	E8330X_DG	737	1
	Metal Gold Hairline	E8330X_GH	771	1
	Dark Wood	E8330X_WD	771	1
2 Gang Blank Plate	White	E8330TX_WE	685	10
	Wine Gold	E8330TX_WG	1063	10
	Dark Grey	E8330TX_DG	1063	1
	Metal Gold Hairline	E8330TX_GH	2947	10

Please contact Customer Care Center for Stockable and Non stockable status of references.
*Bold references are MTO reference.

AvatarOn - It's also a Switch



E8331BPDMW_WE_G8



E8331KPB_WE



E8332C_WE_G8



E8332C_WD_G8



E83T727V_WE



E83T727V_WD



E8331RJS4_WE



E8331RJS4_WD

Product Description	Color	Product Ref. No.	Unit MRP ₹	Pack
Hotel Series				
DND, PCU, PW Indicator with Bell Switch (Do Not Disturb, Please Clean Up, Please Wait)	White	E8331BPDMW_WE_G8	7042	1
	Wine Gold	E8331BPDMW_WG_G8	10562	10
	Dark Grey	E8331BPDMW_DG_G8	10562	1
16AX 3 Gang Switch with PCU, DND, PW Sym (Do Not Disturb, Please Clean Up, Please Wait)	White	E8333DMWS_WE_G8	6702	1
	Wine Gold	E8333DMWS_WG_G8	9779	10
	Dark Grey	E8333DMWS_DG_G8	10244	1
	Dark Wood	E8333DMWS_WD_G8	10435	10
250V 16A Electronic Keycard Switch	White	E8331EKT_WE	12536	1
	Wine Gold	E8331EKT_WG	18806	1
	Dark Grey	E8331EKT_DG	18805	1
Panic Button with Key Reset	Dark Wood	E8331EKT_WD	19700	1
	White	E8331KPB_WE	2352	1
	Wine Gold	E8331KPB_WG	3456	1
10A 2 Gang Mechanical Curtain Switch	Dark Grey	E8331KPB_DG	2971	1
	White	E8332C_WE_G8	1459	1
	Wine Gold	E8332C_WG_G8	2189	10
	Dark Grey	E8332C_DG_G8	2189	1
	Metal Gold Hairline	E8332C_GH_G8	2189	10
115/240V 20VA Universal Version Shaver	Light Wood	E8332C_LW_G8	2433	10
	Dark Wood	E8332C_WD_G8	2189	10
	White	E83T727V_WE	6958	1
	Wine Gold	E83T727V_WG	11269	1
	Dark Grey	E83T727V_DG	11808	1
Connection Units	Metal Gold Hairline	E83T727V_GH	11808	1
	Dark Wood	E83T727V_WD	12370	1
	Wine Gold	E8331DFSGN_WG	6339	10
13A 250V 1 Gang Fused Connection with DP Switch and Neon				
25A 250V 1 Gang Connection Unit	Metal Gold Hairline	E8331TB_GH	2743	10
Telecom, Network, Connectivity & Media Series				
1 Gang Telephone Socket, Shuttered Wallplate	White	E8331RJS4_WE	1084	1
	Wine Gold	E8331RJS4_WG	1808	1
	Dark Grey	E8331RJS4_DG	1808	1
	Metal Gold Hairline	E8331RJS4_GH	1808	1
	Light Wood	E8331RJS4_GH	1808	1
	Dark Wood	E8331RJS4_WD	1808	1

Please contact Customer Care Center for Stockable and Non stockable status of references.
*Bold references are MTO reference.

AvatarOn - It's also a Switch



E8332RJS4_WE



E8331RJS5_WE



E8332RJS5_WE



E8331RJS6_WE



E8332RJS6_WE



E8331TV_WE



E8331TVSF_WE



E8332TDRJS5_WE



E8332TVRJS5_WE



E8332HDUSB_WE



E8332HDHD_WE



E8331RJS_WE



E8332RJS_WE

Product Description	Color	Product Ref. No.	Unit MRP [₹]	Pack
2G Tel Socket, Shuttered Wallplate	White	E8332RJS4_WE	2661	1
	Wine Gold	E8332RJS4_WG	3996	1
1 Gang RJ45 Data Cat5E, Shuttered	White	E8331RJS5_WE	1695	1
	Wine Gold	E8331RJS5_WG	2957	1
	Dark Grey	E8331RJS5_DG	2822	1
	Metal Gold Hairline	E8331RJS5_GH	2822	1
	Dark Wood	E8331RJS5_WD	2957	1
2 Gang RJ45 Data Cat5E, Shuttered	White	E8332RJS5_WE	3099	1
	Wine Gold	E8332RJS5_WG	5168	1
	Dark Grey	E8332RJS5_DG	4933	1
1 Gang RJ45 Data Cat6, Shuttered	Metal Gold Hairline	E8332RJS5_GH	4933	10
	White	E8331RJS6_WE	2026	1
	Wine Gold	E8331RJS6_WG	3037	1
2 Gang RJ45 Data Cat6, Shuttered	Dark Grey	E8331RJS6_DG	3037	1
	White	E8332RJS6_WE	3795	1
	Wine Gold	E8332RJS6_WG	5694	1
1 Gang TV Socket, 75Ω, Through-Connect	Dark Grey	E8332RJS6_DG	5694	1
	White	E8331TV_WE	855	1
	Wine Gold	E8331TV_WG	1424	1
	Dark Grey	E8331TV_DG	1424	1
	Metal Gold Hairline	E8331TV_GH	1424	10
1 Gang TV Socket, Slave 5-1000	Dark Wood	E8331TV_WD	1424	1
	White	E8331TVSF_WE	945	10
	Wine Gold	E8331TVSF_WG	1583	0
1 Gang Tel + RJ45 Data Cat5E, Shuttered	Dark Grey	E8331TVSF_DG	1508	1
	White	E8332TDRJS5_WE	2661	1
	Wine Gold	E8332TDRJS5_WG	4437	1
	Dark Grey	E8332TDRJS5_DG	4236	1
	Metal Gold Hairline	E8332TDRJS5_GH	4236	1
1 Gang TV+ RJ45 Data Cat5E, Shuttered	Dark Wood	E8332TDRJS5_WD	4437	1
	White	E8332TVRJS5_WE	3300	1
	Wine Gold	E8332TVRJS5_WG	5507	1
	Dark Grey	E8332TVRJS5_DG	5255	1
	Metal Gold Hairline	E8332TVRJS5_GH	5255	1
1 Gang TV+ RJ45 Data Cat6, Shuttered	Dark Wood	E8332TVRJS5_WD	6118	1
	White	E8332TVRJS6_WE	3300	1
	Wine Gold	E8332TVRJS6_WG	5507	1
HDMI + USB Socket	Dark Grey	E8332TVRJS6_DG	5255	1
	White	E8332HDUSB_WE	7033	1
	Wine Gold	E8332HDUSB_WG	11720	8
2 Gang HDMI+HDMI, Keystone on Wallplate	Dark Grey	E8332HDUSB_DG	11187	1
	White	E8332HDHD_WE	3857	1
Volume Control, 5W, 8Ohm	Wine Gold	E8331VC_WG	4648	10
	Dark Grey	E8331VC_DG	4645	1
1 Gang S Keystone Wallplate (w/o Mod)	White	E8331RJS_WE	855	10
	Wine Gold	E8331RJS_WG	1282	10
	Dark Grey	E8331RJS_DG	1316	1
2 Gang S Keystone Wallplate (w/o Mod)	White	E8332RJS_WE	1563	10
	Wine Gold	E8332RJS_WG	2343	10
	Dark Grey	E8332RJS_DG	2342	1

Please contact Customer Care Center for Stockable and Non stockable status of references.
*Bold references are MTO reference.

Kavacha - Weather Protected Series



CSW110-GY-EX



A3031WBP_WE

- Pleasing looks with **IP56 protection**
- Large press switch
- Co-moulded sealing with no risk of gasket damage
- Chemical resistant & UV stabilised

Description	Reference	Unit MRP [₹]	Pack
Kavacha IP56 Surface Mount Combined Switched Socket Outlets			
Combination Switch Socket Outlets			
16A Single Pole Switched Socket Outlet	CSC316RP_GY	5318	1
Kavacha IP56 Surface Mount Socket Outlets			
16A Socket Outlet	CSO316RP-GY-EX	3757	1
Kavacha Full-Time Weatherproof Cover			
Full-Time Weatherproof Single Gang Socket Cover (Transparent) IP55	E223R_TR	1360	1
Weatherproof Bell Press Grey	A3031WBP_GY	2077	1
Weatherproof Bell Press White	A3031WBP_WE	1815	1

Please contact Customer Care Center for Stockable and Non stockable status of references.

*Bold references are MTO reference.

Metal Boxes



- **Weld free design** to minimize corrosion and rusting without compromising on strength
- Mounting clip and earth pin designed for **easier installation** and to **avoid loss during transportation**
- Removable side plates and optimized knock outs and for **easier wiring**
- Completely tested & validated as per **IS 14772**

Description	Reference	Unit MRP ₹	Pack
Metal Boxes for Indian Format Ranges (Livia, Opale, Clipsal X, Unica Pure & ZENcelo India)			
0.8 mm thickness			
Metal Box 1 & 2 modules	ME0102	121	20
Metal Box 3 modules	ME0103	158	20
Metal Box 4 modules	ME0104	181	20
1 mm thickness			
Metal Box 1 & 2 modules	MR1102	135	20
Metal Box 3 modules	MR1103	178	20
Metal Box 4 modules	MR1104	205	20
Metal Box 6 modules	MR1106	279	10
Metal Box 8 modules - Horizontal	MR1108	362	10
Metal Box 8 modules - Square	MR1109	362	10
Metal Box 12 module	MR1112	465	5
Metal Box 18 modules	MR1118	552	5

Description	Reference	Unit MRP ₹	Pack
Metal Boxes for BS Format Ranges (AvatarON) - New & Improved Design			
Use Bracket/Frame to ensure alignment of switches on 2/3/4 Gang Metal Box (refer to AvatarOn section for references)			
1 mm thickness			
2 GANG GI Metal Boxes	MM1102	353	20
3 GANG GI Metal Boxes	MM1103	499	20
4 GANG GI Metal Boxes	MM1104	646	20

Please contact Customer Care Center for Stockable and Non stockable status of references.

*Bold references are MTO reference.

Smart Home Energy Management System



The Future of Homes

It's Time to
Get **Wiser**



Smart Home **Energy Management** System

With the rise of the Internet of Things (IoT), automation has simplified our lives and made our homes smarter. Smart homes, the foundation of smart cities, offer a more secure lifestyle by automating functions and providing greater control over living spaces.

Introducing **Wiser**, the next leap in Home Energy Management. Schneider Electric's vision for a sustainable, connected home of the future enables every device to be easily controlled and personalized through the Wiser Home Application.

Wiser offers an intuitive system with tools to control electricity usage and optimize energy needs without sacrificing comfort. It goes beyond convenience and security, empowering smarter, more sustainable living. Wiser homes focus on people, adding a new dimension to Stylish, Smart, Sustainable and Safe.

Together, we are creating the homes of the future by connecting electricity with digital solutions to help you achieve your sustainability goals.

Home Automation Possibilities



Semi Home Automation

- Lighting Control
- Fan Control
- HVAC Control
- Curtain Control
- Dimming – 10-100%
- Voice, App Control



Full Home Automation

- Mood Creation
- Geo-Fencing
- Digital Door-Lock Integration
- Sensor Based Automation
- Air Quality Management



Safety

- Appliance Protection
- Arc Fault Protection
- Thermal Protection



Home Energy Management

- Energy Monitoring
- Energy Efficiency Features
- Prosumer Management
- NEL Integration



AI / Machine Learning

- Lifestyle Recommendations
- Energy Saving Tips
- Appliance Management Tips



Wiser: One System. Infinite Control.

Make your home **Smart and Sustainable** with **Wiser**



SE Ref.	Description of reference	Unit MRP [₹]
CS16A1MSW_WE*	16A 1M Connected Switch, White	7200
CS16A1MSW_GY*	16A 1M Connected Switch, Grey	9450
CD4SFR2M_WE*	4 Step Connected Fan Regulator, White	7600
CD4SFR2M_GY*	4 Step Connected Fan Regulator, Grey	9800
ENMOD1P*	Energy Monitoring Device, Single Phase	On Request
ENMOD3P*	Energy Monitoring Device, Three Phase	On Request
CCIRC1M*	IR Controller- Wi-Fi	On Request
CR2CHRLYPG*	5A 2 Channel Relay Puck- Wi-Fi	On Request
CDWRLY1CH16A*	16A 1 Channel Connected Relay Puck- Wi-Fi	On Request
B1GTEWY*	Multi-Protocol Gateway	On Request
IH100WFVDP*	Smart Doorbell	On Request
IH14000100*	4 Channel Automation Relay	On Request
IH1200010F*	Fan Speed Controller	On Request
IH12000020*	2 Channel Dimmer Controller	On Request
IH101ZW2IR*	ZW_IR Controller	On Request
IH11000200*	2 Channel Curtain Controller	On Request
IH101ZWIFI*	Automation Gateway	On Request

Please contact Customer Care Center for Stockable and Non stockable status of references.

*Bold references are MTO reference.

Surface and Flush Mount Occupancy Sensors



PIR, Ultrasonic Sensors & High Frequency sensor suitable for both Surface & Flush Mount

Description	Reference	Unit MRP [₹]
Surface Mount Single-Load 360 degrees PIR	CSS54E_WE	4140
Flush/Surface Mount Single-Load 360 degrees PIR	SAE-UE-MS-CSAWE	5043
ARGUS Presence Dual-Tech PIR & Ultrasonic Sensor - 1ch	CCT551011	16588
ARGUS Presence Dual-Tech PIR & Ultrasonic Sensor - 2ch	CCT551012	17821
ARGUS IR Remote Controller Dual-Tech	CCT556011	23596
ARGUS Presence High Frequency High Bay Sensor - 2ch	CCT551023	19503
ARGUS IR Remote Controller HF	CCT556023	21631
ARGUS Presence Wide Sense - 2ch	CCT551003	16514
INFRASCAN OUTDOOR 3WIRE 10A	750WPR-GY	25305
INFRASCAN INDOOR 3WIRE 10A	751R-WE	14682
INFRASCAN 360 DEGREE 3WIRE	753R-WE	12752



PIR Flush Mount Sensors

Description	Reference	Unit MRP [₹]
ARGUS Standard min 360° False ceiling indoor movement detector	CCT570005	5902
ARGUS Standard 360° False ceiling indoor movement detector - 2ch	CCT570003	8664
Flush Mount Dual load 360 degrees standalone sensor	SAE-UE-MS-CDBWE	9864



Dimmable Sensors with Light Regulation

Dali Dimmable Sensor

Description	Reference	Unit MRP [₹]
ARGUS Presence Master with IR, DALI	MTN5510-1519	17821

Please contact Customer Care Center for Stockable and Non stockable status of references.
*Bold references are MTO reference.

W.E.F. June 10th, 2026

Wall Mount Sensors



BS Standard & Outdoor IP55 Sensor

Description	Reference	Unit MRP [₹]
Neo C-Metro 200 degrees wall mount sensor, grey colour	E3751MS3C_GS	7881
Zencelo 110 degrees wall mount sensor, white colour	E84751MS3B_WE	7980
Zencelo 90 degrees wall mount sensor, white colour	E84751MS3A_WE	6085
Argus 110 Electronic outdoor movement detector, angle of detection 110 degrees, max. range 12 mtrs, IP55 protection	MTN565119	8688
Argus 220 Electronic movement detector for outdoor ceiling mounting angle of detection 220 degrees, max. range 12 mtrs, IP55 protection	MTN565219	13406

Hotel - ELV Dual Motion Sensor

Description	Reference	Unit MRP [₹]
ELV DUAL TECH MOTION SENSOR	SAE_UE_MS_CULV_WE	11022

Please contact Customer Care Center for Stockable and Non stockable status of references.
*Bold references are MTO reference.



Schneider Electric India Pvt. Ltd.

Corporate Office: 15th Floor, DT-4 Downtown, DLF Phase 3, Sector 25A, Gurugram, Haryana - 122002

Ahmedabad

Schneider Electric India (P) Ltd.
1506-1507, 15th Floor Shapth-5
Opp.Karnavati Club, SG Highway,
Ahmedabad, Gujarat - 380015
Tel.: 079-66826701

Bengaluru

Schneider Electric India (P) Ltd.
No. 3/1, JP Techno Park
Mezzanine Floor, Millers Tank Bund
Road, Vasanth Nagar
Bengaluru - 560052
Tel.: 080-71481351

Bhubaneswar

Schneider Electric India (P) Ltd.
Workloop Co-Working in the property
Office No. 316, Esplanade One Mall
Rasulgarh, Bhubaneswar - 751010

Chennai

Schneider Electric India (P) Ltd.
No: 29, 2nd Floor,
Bannari Amman Towers, B-Block
Dr. Radhakrishnan Road, Mylapore
Chennai - 600 004
Tel.:044-71912000

Cochin

Schneider Electric India (P) Ltd.
Alapatt Properties Private Limited
(Trade Name: Centre A)
Main Door Number: 66/4971
(Old Door Number: 40/6584-H)
7th Floor Alapatt Heritage Building
MG Road Kochi - 682035

Coimbatore

Schneider Electric India Pvt. Ltd.
Mikro Grafeo Services Pvt Ltd.,
Elysium Tower, #21, A.TT
Colony, Near Honda Office,
Coimbatore, Tamil Nadu - 641018

Hyderabad

Schneider Electric Pvt. Ltd.
4B-4th Floor, Gumidelli Towers,
Prakash Nagar, Begumpet,
Hyderabad - 500016

Indore

Schneider Electric India (P) Ltd.
219, Dhan Trident Building
Vijay Nagar, A.B.Road
Indore - 452001

Jaipur

Schneider Electric India (P) Ltd.
Jaipur Business Centre 309
3rd Floor, Sangam Tower 190
Church Road, Jaipur - 302001
Tel.: 0141-2374810

Kolkata

Schneider Electric (I) Pvt. Ltd.
BN3, Salt Lake, Sector V,
Kolkata - 700091

Lucknow

Schneider Electric India (P) Ltd.
Summit, Plot No. TCG 3/3
6th Floor, 604A/B/C, Vibhuti Khand
Gomti Nagar, Lucknow
Uttar Pradesh - 226010
Tel.: 0522-3500334

Ludhiana

Schneider Electric India (P) Ltd.
SCO 23, 2nd Floor,
Chandigarh Road, Sector 32
Ludhiana, Punjab -141010
Tel.: 0161- 5203011

Mohali

Schneider Electric India (P) Ltd.
2nd Floor, Tower-A
Bestech Business Tower
Mega Information & Technology Park
Industrial Plot No.1, Phase IX
(Expansion), Mohali - 160059
Tel.: 0172-7198200

Mumbai

Schneider Electric India Pvt. Ltd.
L&T Business Park, Tower B,
7th Floor, TC-II, Gate No.5,
Saki Vihar Road, Powai,
Mumbai - 400072

Nagpur

Schneider Electric India (P) Ltd.
6, Vasant Vihar Complex
W.H.C Road, Shankar Nagar
Nagpur - 440010
Tel.: 0712-2558581

Nashik

Schneider Electric India (P) Ltd.
401, 4th Floor, Rishi Raj Towers
Jehan Circle, Gangapur Road
Nashik - 422013
Tel.: 0253-2344333

New Delhi

Schneider Electric India (P) Ltd.
C-56, Mayapuri Industrial Area, Phase-2
New Delhi - 110064
Tel.: 011-61317400

Pune

Schneider Electric India (P) Ltd.
Amar Caliber, CTS No 911, BMCC Road,
OFF F.C. Road, Deccan Gymkhana,
Shivaji Nagar, Pune - 411007
Tel.: 020-67492500

Vadodara

Schneider Electric India (P) Ltd.
Notus IT Park, 10th Floor, Block-D
Sarabhai Campus, Vadiwadi
Vadodara, Gujarat - 390017

Vishakhapatnam

Schneider Electric India (P) Ltd.
D.N.10-1-43, 1st Floor
Ratnam's Business Centre,
Siripuram Fort, C.B.M.Compound
Visakhapatnam - 530016
Tel.: 0891-6675500

Customer Care Centre

Monday-Saturday, 9 a.m. to 8 p.m.

Toll-free numbers: 1800 419 4272, 1800 103 0011

Email: customercare.in@schneider-electric.com

For more information, visit our website at: www.se.com/in

- All Prices are in Indian Rupees
- Prices are subject to change without prior notice
- Product evolution is a continuous process and Schneider Electric reserves the right to modify/withdraw any product at any time without prior notice
- Prices charged will be as prevailing on the date of dispatch
- Invoice Amount = (MRP – less Applicable discount) + Applicable GST %
- Tax incidence on invoices is basis applicable GST rates
- Invoice amount not to exceed MRP
- Product pictures shown are for illustration purpose only; actual product may vary
- Kindly refer product datasheet for detailed specification
- SE recommends to procure products from our authorized sellers only, list of our authorized sellers can be found on <https://www.se.com/in/en/work/support/locator/partner-map/>

Distributor