

W.E.F : 04 Novemeber 2021

PeCOX[®]

Quality Never Dies
Engineered For Electrical Control Panels



“Your Partner
In
Electrical Control Panels Accessories”



2021
Product Catalog



Reject Single Use Plastic

63

Countries have extended producer responsibility or companies to take back single-use plastic from consumers

27

Countries have banned specific products like plates, cups and straws or material like polystyrene

PeCOx[®]
Quality Never Dies

*Invites you to be a partner in
GREEN INDUSTRIAL REVOLUTION
in INDIA*

8

Countries have banned Microbeads, which are plastic particles less than or equal to 5mm size

PeCox uses only **Engineering Grade Recyclable Thermoplastic**.

We do not use any form of **Single Use Plastic** -

Thermoset plastic category such as DMC, SMC, Bakelite, Mellamine, etc...

"The choices that we make today will define our collective future"
...India has pledged to eliminate all single use plastic by 2020 and ...so do We...

 Save EARTH...Think **PeCOx**[®]
Quality Never Dies



Who Are We....?

PeCox is an upcoming name in the field of "Electrical Control Panel Accessories". Established in the year 2015, with an ultimate aim of serving the Control Panel Industry with an extremely Innovative Concept, Strategic Design saving Labor-cost bundled with Extraordinary Quality.

PeCox has been started by a team of professionals who have rich expertise of plastic vertical, mechanical vertical & the practical experience in the Electrical Control panel industry. Product range is categorized into 4 verticals- Panel Hardware, Cable Termination, Cable Management & Marking and Polyamide Low Voltage bus bar supports.

Company Vision

At PeCox, our objective is to create a range of world class Electrical Control Panel Accessories uniquely designed & crafted to achieve a sustainable growth with a key focus on the Environment.

Our commitment to the Control Panel Industry. . . "Distinctive & Compact Designs(which also saves Labor cost) Recyclable/Eco Friendly Raw materials, Better Insulation at Affordable Pricing".

Company Mission

At PeCox, we understand the technical hitches in the traditionally enduring panel accessories and so have developed a range of products which help overcome these typical problems. Our endeavour is to develop world class Eco-Friendly panel accessories by substituting their basic raw material from THERMOSET to GLASS-FILLED ENGINEERING GRADE THERMOPLASTIC which exhibits:

- Recyclable in nature
- Superior degree of Mechanical & Electrical Strength
- High Tensile Strength

Unique & aesthetically astounding designs have been crafted keeping the mounting alike. Most of the products comply with RoHS directives & meet the requisite parameter of Ingression Protection (IP), High Voltage, Flame Retardant, Load Bearing Test, Torque Test etc as and where required duly tested by third party laboratories such as CPRI, Spectro, SGS etc.

Taking into consideration all the aspects we have still tried to bridge the gap of price & quality by adopting the multi-cavity production technique.

Product Description

Panel Air Vents/ Air Filters Screw Fit

Material

ABS

Colour

Pecox - RAL7035 / Blue/Orange

P-Konnect - Grey

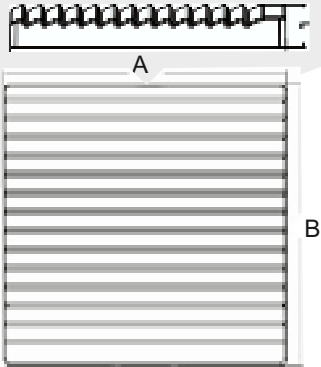

Why PECOX?

- "Twist-to-Open" for outer cover.
- "Curve Shaped" for exaggerating the heat dissipation.
- "Dust Protector" from direct impact from dust.
- "Additional fan mounting" for next lower fan size

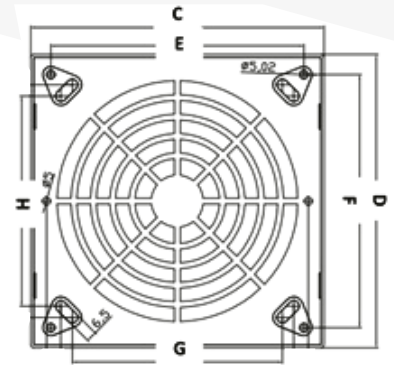

Technical Datasheet

Product Code	Size (mm)						Fan Mounting Size(mm)		Filter Height	For Fan Size(inch)
	Front		Back	Panel Mounting		G	H	L		
	A	B	C	D	E	F	G	H	L	
PAV/PKF01	131	131	127	127	105	105	90 ± 3	90 ± 3	25	4
PAV/PKF02	185	185	180	180	155.56	155.56	134 ± 5	134 ± 5	27	6
PAV/PKF03	238	238	231	231	202.94	202.94	170 ± 3	170 ± 3	31	8

Packaging & Pricing

Product Code	List Price (Rs.)	Unit	Specification	Standard Packing (No.)	Master Packing (No.)
PKF01 **	50.00	No.	Screw Type 4"	1	300
PKF01 VP **	46.25	No.	Screw Type 4"	10	300
PKF02 **	107.00	No.	Screw Type 6"	1	150
PKF03 **	213.00	No.	Screw Type 8"	1	80
PAV01	70.00	No.	Screw Type 4"	1	300
PAV01 VP	66.25	No.	Screw Type 4"	10	300
PAV02	170.00	No.	Screw Type 6"	1	150
PAV03	327.00	No.	Screw Type 8"	1	80
PAV06 FA	98.00	NO.	Screw Type 8"	1	80

** "P-konnet" - Series - An ECO Brand of PECOX. | VP is PeCox Value Pack (10 Pcs Box)

Product Description

Panel Air Vents/ Air Filters Screw Fit (Sleek Design)

Material

ABS

Colour

RAL7035 / Blue / Orange

Gasket

EPDM Sponge Rubber



Why PECOX?

- "Sleek Design" minimizes the possibility of being damaged during transit.
- "Press To Open" by screw driver, option provided on top for easy operation.
- "Optional Interlocking" option provided to lock the front cover
- "Optional Additional Lower size fan mounting option.
- "Curved Shped" Accelerates heat dissipation & protects from dust.
- **Ip54 Protection** - Tested by Spectro Lab.
- **RoHS** - Tested by SGS.

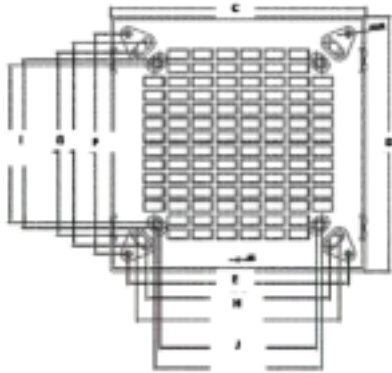

Technical Datasheet

Product Code	Overall Size (mm)		Cut Out Size (mm)		Screw Mounting Provision (mm)		Fan Mounting Provision (mm)		For Fan Size (Inch)	Fan Mounting (Additional Provision)(mm)		For Fan Additional Size (Inch)
	A	B	C	D	E	F	G	H	I	J		
PAV005	92	92	87	87	71	71	71	71	3"			
PAV015	131	131	127	127	105	105	105	87	4"	107.8	107.8	3"
PAV025	185	185	180	180	155.5	155.5	136±6	136±6	6"	159.3	159.3	4"

Packaging & Pricing

Product Code	List Price (Rs.)	Unit	Specification	Standard Packing (No.)	Master Packing (No.)
PAV005	58.00	No.	Screw Type - 3"	1	600
PAV015	70.00	No.	Screw Type - 4"	1	300
PAV015 VP	67.00	No.	Screw Type - 4"	10	300
PAV025	158.00	No.	Screw Type - 6"	1	150

Note: VP is pecox Value Pack (10 Pc Pr Box)

Product Description

Fan attachment unit-Dome Type

Material
ABS

Colour
Grey RAL7035



NEW

Why PECOX?

- Fan Attachment Unit act as a Mounting unit for Fans wherein the airvents are not used and ventilation is provided through fins in the panel door.
- It may also be used in combination with AirVents PAV06/PAV02/PKF02/PAV02S turning it as a FanMounting Unit (Dome Type) panel air vent

Packaging & Pricing

Product Code	List Price (Rs.)	Unit	Specification	Standard Packing (No.)	Master Packing (No.)
PAV06FA	98.00	No.	Suitable for Mounting 4" Fan	5	90

Panel AirVent Cum Breather (IP65)

Product Description

Panel Airvents with Breather
Screw Mounting

Material
Polycarbonate UV stablized

Gasket
EPDM

Colour
Grey RAL7035



NEW

Why PECOX?

- Best Suitable for outdoor applications needing IP65 Protection

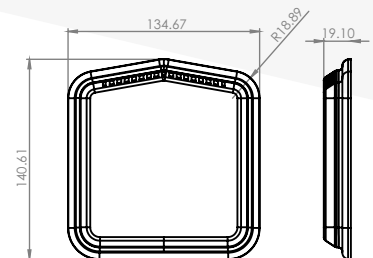
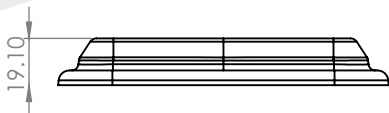

Packaging & Pricing

Product Code	List Price (Rs.)	Unit	Mounting Dimension	Standard Packing (No.)	Master Packing (No.)
PAV10UV	400.00	No.		0	0

Product Description

Panel Air Vents/ Air Filters Snap Fit

Material

ABS

Colour

RAL7035 / Blue / Orange

Gasket

EPDM Sponge Rubber



Why PECOX?

- "Curve Shaped" accelerates heat dissipation & protects from direct impact of dust.
- Optional Internal Locking system of cover.
- Optional for next Lower Size Fan mounting option.
- **Ip54 Protection** - Tested by Spectro Lab.
- **RoHS** - Tested by SGS.

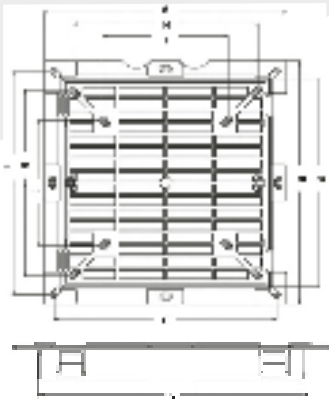

Technical Datasheet

Product Code	Overall Size (mm)		Cut Out Size (mm)		Screw Mounting Provision (mm)		Fan Mounting Provision (mm)		For Fan Size (Inch)	Fan Mounting (Additional Provision)(mm)		For Fan Additional Size (Inch)	Front Overall Size (mm)	
	A	B	C	D	E	F	G	H		I	J		K	L
PAV04/PKF04	145	145	122.5	122.5	137	137	107.8	107.8	4"				148	148
PAV06/PKF06	208	208	176.5	176.5	191	191	159.3	159.3	4"/6"	107.8	107.8	4"	213	213
PAV07	254	254	222.5	222.5	239	239	202.9	202.9	6"/8"	159.3	159.3	6"	260	260
PAV08	316	316	290.5	290.5	304	304	262	262	8"/10"	202.9	202.9	8"	322	322

Packaging & Pricing

Product Code	List Price (Rs.)	Unit	Specification Type & Size For Fan Size	Standard Packing (No.)	Master Packing (No.)
PKF04**	77.50	No.	Snap Type 4" Air Vent - 4"	1	240
PAV04	103.00	No.	Snap Type 4" Air Vent - 4"	1	240
PKF06**	170.00	No.	Snap Type 6" Air Vent - 6"	1	90
PAV06	245.00	No.	Snap Type 6" Air Vent - 6"	1	90
PAV07	372.00	No.	Snap Type 10" Air Vent - 8"	1	55
PAV08	780.00	No.	Snap Type 12" Air Vent - 10"	5	30

** "P-konnet" - Series - An ECO Brand of PECOX. | VP is PeCox Value Pack (10 Pcs Box)

Meter Window Glass - Screw Fit

Product Description

Panel Meter Glass Screw Fit

Material

CRYSTAL

Gasket

Sponge Rubber

Colour

Transparent (Clear)



Why PECO?

- Pre- fitted "Sponge Rubber Gasket" in the meter glass, saving labor time.
- Mounting Screws Enclosed.

Packaging & Pricing

Product Code	List Price (Rs.)	Unit	Overall Size (mm)	Standard Packing (No.)	Master Packing (No.)
PKMG01	31.50	No.	96x96	20	600

Meter Window Glass - Snap Fit

Product Description

Panel Meter Glass Snap Fit

Material
Polycarbonate
(UV Stabilized)

Suitability
1.6 mm & 2mm
Thick panel Sheet

Colour

Transparent (Clear)

Gasket

EPDM

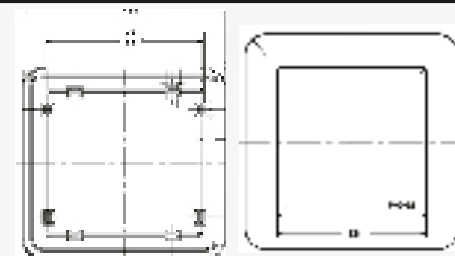

PMG02

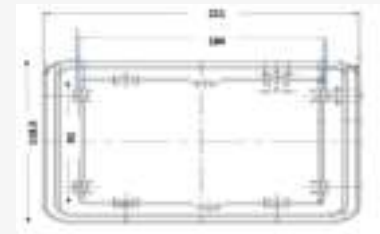

PMG03



Why PECO?

- Saves Labor time - No drilling & fixing screws.
- Polycarbonate reduces the probability of Breakage during the transit..
- UV Stabilized Polycarbonate material makes it more transparent & insurgents to any weather conditions.
- RoHS- Tested by SGS.

Packaging & Pricing

Product Code	List Price (Rs.)	Unit	Overall Size (mm)	Cut Out Size (mm)	Standard Packing (No.)	Master Packing (No.)
PMG02	62.50	No.	96x96	92x92	20	600
PMG03	130.00	No.	118.5x211	92x184	5	300

Product Description Din Rail Channels

Material
Cold Rolled Steel

Colour
White

Plating
Electro Plating 'trivalent Blue'
with >5 microns



Why PECO?

➤ Accurate Thickness as per industry standards.



PMCHSW3575

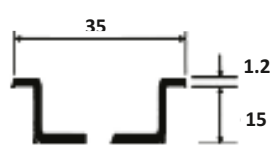

PMCHSW3515

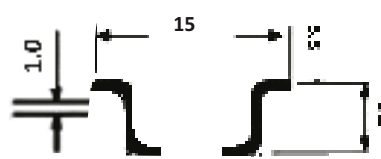

PMCHSW1555

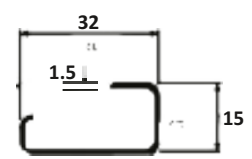

PTBCHSW3215

Technical Data Sheet, Pricing & Packaging

Product Code	List Price(Rs.)	Unit	Description	Specification (mm)	Standard Packing (Mtr)	Master Packing (Mtr)
PMCHSW3575	105.00	Mtr	MCB Mounting Channe (1mmThickness)	35 x 7.5 x 1	100	-
PMCHSW357509	96.00	Mtr	P-konnect MCB Mounting channel (0.9mm Thickness)	35 x 7.5 x 0.9	100	-
PMCHSW3575N	116.00	Mtr	Easy Cut MCB Mounting channel(1mm Thickness)	35. x 7.5 x 1	100	-
PMCHSW3515	200.00	Mt	Contactora/ MCB Mounting Channel-Deep(1.2mm thickness)	35 x 15 x 1.2	50	-
PMCHSW351515	215.00	Mtr	Contactora/ MCB Mounting Channel-Deep(1.5mm thickness)	35 x15 x 1.5	50	-
PMCHSW1555	73.50	Mtr	Micro Channel (1mm Thickness)	15 x 5.5 x 1	100	-
PTBCHSW321512	183.00	Mtr	Terminal Block Channel (1.2mm Thickness)	32 x15 x 1.2	50	-
PTBCHSW3215	223.00	PC	Terminal Block Channel (1.5mm Thickness)	32 x15 x 1.5	50	-
PDRC	84000.00	PC	Universal Din Rail Cutting Tool		1	
PDRCM	36750.00		Din RailCutter for PMCHSW3575		1	



PDRC



PDRCM

Product Description

Stoppers/End Clamps For Din Rails

Material

Engineering Grade Thermoplastic/MS



NEW



Why PECOX?

➤ Range of Stoppers provides a Cost Advantages keeping the quality intact.



PSCUN



PECP



PSCKN



PSCS



PSCKNMLH



PTBS1

Technical Data Sheet, Pricing & Packaging

Product Code	List Price(Rs.)	Unit	Specification	Standard Packing (No.)	Master Packing (No.)
PSCUN	11.50	No.	Polyamide Stopper Universal Mounting (Suitable for C&G Channel)	100	2600
PECP	9.40	No.	Polyamide Stopper Universal Mounting	100	2400
PSCKN	9.00	No.	Polyamide Stopper Suitable for 'C' (MCB) Channel	100	4000
PSCS	7.5	No.	MS Stopper Suitable for 'G' / Terminal Block Channel	100	2000
PSCKNMLH	18.00	No.	Polymide Stopper for Marking Holder & Shroud	100	4000
PTBS1	75.00	No.	Polycarbonate Shroud-300mm * 60mm	100	2000

Panel Lock - Metallic

Product Description

Metallic Panel Lock 22.5 mm

Material

Zinc Alloy(Zamark3) with MS Lever

Gasket

EPDM

Chucknut

Zinc Alloy(Zamark3) with Knurling

Inserts Available

Center Pin(PPL01), Minus(PPL02), Triangle(PPL03)

Square(PPL04), Hexagonal(PPL05)

Bends Available

20mm, 25mm.

30mm, 35mm,45mm

(At Extra cost).



Chuck - Nut



Gasket



Why PECOX?

- Chucknut with Knurling for proper gripping..
- EPDM Gasket to provide IP54 protection.

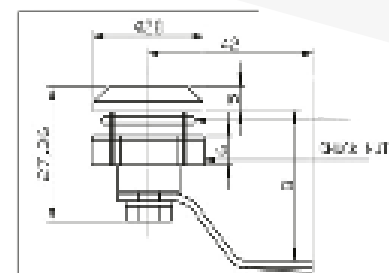
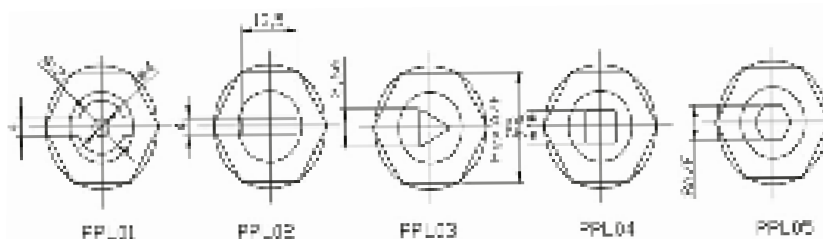
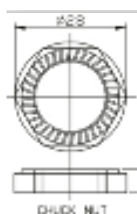

Packaging & Pricing

Product Code	List Price (Rs)	Unit	Specification	Standard Packing (Nos)	Master Packing (Nos)
PPL01/02/03/04/05	80.00	Nos	22.5 mm	25	600

Panel Key

Product Description

Panel Key

Body Material

Zinc Alloy(Zamark3)

Inserts Available

Center Pin, Minus, Square, Triangle, Hexagonal



Why PECOX?

- Compact Design to accommodate easily in key-chain.

Packaging & Pricing

Product Code	List Price (Rs)	Specification	Standard Packing (No.)	Master Packing (Nos)
PPKL01/02/03/04/05	37.50	For Metallic Lock	100	1000

Panel Lock - Polyamide

Product Description

Polyamide Panel Lock 22.5 mm

Material

Polyamide body With Metallic insert & MS Lever

Chucknut

Zinc Alloy(Zamark3) with knurling

Gasket

EPDM

Inserts Available

Center Pin(PPLP01), Minus(PPLP02), Triangle(PPLP03), Square(PPLP04), Hexagonal(PPLP05)

Bends Available

20mm, 25mm, 30mm, 45mm.

Spanner Size

26



Why PECOX?

- ▶ Deep Threading avoid Thread failure.
- ▶ Polyamide chucknut is spanner operated which ease the fastening process. Saves Labor Cost.
- ▶ EPDM Gasket provides IP54 protection to the panels.
- ▶ Polyamide Handle(at extra cost)in combination with Lock is best suitable for small Distribution Boxes.
- ▶ Zinc/Polyamide Heavy Chucknut with knurling provides proper gripping.
- ▶ Powder Coated(RAL7035) Inserts contrast with the Panel Color, making it asthetically better.



Polyamide Chuck-Nut Zinc Chuck-Nut

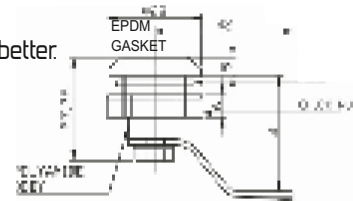
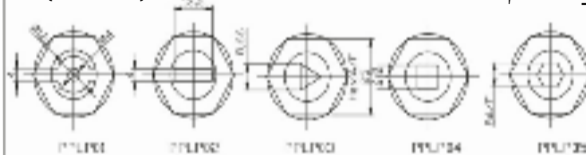
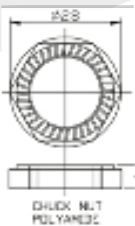

Packaging & Pricing

Product Code	List Price (Rs)	Unit	Specification	Insert	Standard Packing (Nos)	Master Packing (Nos)
PPLP-01/02/03/04/05M	41.25	Nos	Polyamide Lock 22.5 mm (Lever Height 20 or 25mm)	Aluminium Die-Casted	25	600
PPLPZ-01/02/03/04/05M	47.50	Nos	Polyamide Lock 22.5 mm (Lever Height 20 or 25mm)	Zinc Die-Casted	25	600

Note: For 30 mm lever height-kindly add Rs. 2.00/- & for 45mm lever height- kindly add Rs. 6.00/- in above LP.

Panel Lock Accessories



Packaging & Pricing

Product Code	List Price (Rs)	Unit	Specification	Standard Packing (Nos)	Master Packing (Nos)
PPLH	6.00	Nos	Polyamide Handel for panel lock PPL/PPLP series	100	3000
PPLPPL1	17.50	Nos	Polyamide PADLOCK for panel lock PPLP series(Also helps to provide IP55 protection)	100	3000
PL01	175.00	Per Leaf @35 Stickers	Laminated Legend sticker with 3M adhesive for panel lock PPL/PPLP/PPLPT series	50 leafs	
PPLK-U	19.00	Nos	MS sheet key-Universal type for Panel Lock PPLP01/PPLP02 series	100	2400
PPLK-U5	19.00	Nos	MS sheet key for panel lock type PPLP05.	100	2400

Panel Lock - Knob Type

Product Description

knob type Panel Lock

Material

Combination of Polyamide & Metal

Chucknut

Zinc Alloy/Polyamide

Bend Available

25mm & 20mm

Gasket

EPDM

Knob Color

Grey(RAL7035)



Why PECOX?

- Knob Type lock is duly powder coated & in combination with polyamide body, reduces risk of corrosion.

Packaging & Pricing

Product Code	List Price (Rs)	Unit	Specification	Chuck Nut	Standard Packing (Nos)	Master Packing (Nos)
PPLP-T1M	60.00	Nos	Polyamide Lock 22.5 mm	Zinc Casted	25	600

Panel Lock - Rust Free

Product Description

Rust free panel Lock & Knob Type Lock

Material

Combination of Polyamide body with stainless SS304 Lever & SS Screw

Chucknut

Zinc Alloy/Polyamide

Bend Available

25mm & 20mm

Gasket

EPDM



Why PECOX?

- Salt Spray Test

Packaging & Pricing

Product Code	List Price (Rs)	Unit	Specification	Chuck Nut	Standard Packing (Nos)	Master Packing (Nos)
PPLRF-01/02/03/04/05	88.00	Nos	Polyamide Lock 22.5 mm	Zinc Alloyed	25	600
PPLRF-T1	105.00	Nos	Polyamide Lock 22.5 mm with knob	Zinc Alloyed	25	600

Three Point Lock - Polyamide(With Round Rods)

Product Description

Three Point Lock with Round Rod
(optional Pad locking arrangement)

Body Material

Engineering Grade Glass Filled Thermoplastic

Colour
Black

Keys Set
2 NO.



Extended Lever Bolt with 3 lock nuts for adjustment as per door depth

Optional Pad Locking arrangement



Why PECOX?

- Optional Pad Locking arrangement.
- Extended Lever - bolt with extra hardwares, enabling T- Lever to be adjusted as per the depth of the panel.
- Glass filled Thermoplastic Polymer exhibits better mechanical strength compared to other Plastic (PP)
- An extended Thumb Grip.

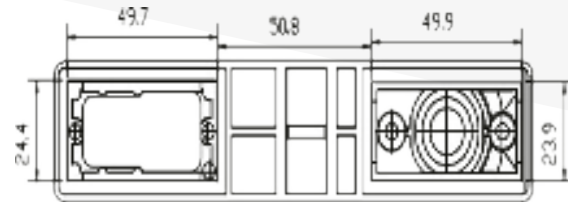

Packaging & Pricing

Product Code	List Price (Rs)	Specification	No. of Round Rods(1050mm)	Mounting Accessories	Pad Locking Arrangement	Standard Packing (No.)	Master Packing (No.)
P3PL00	325.00	Without Rod & Accessories	No	No	Yes	2	100
P3PL01	380.00	With Accessories, Without Rod	No	Yes	Yes	2	100
P3PL02	625.00	With Accessories & Rod (1050mm)	2	Yes	Yes	2	100
P3PL02-1250	690.00	With Accessories & Rod (1250mm)	2	Yes	Yes	2	100

3/5/7 Point Locking - Polyamide(With Flat Rods)

Product Description

Gear Operated Three Point Lock
with Flat Road

Body Material

Engineering Grade Glass
Filled Thermoplastic

Keys Set
2 NO.

Color
Black



Optional Pad Locking arrangement



Why PECOX?

- Optional Pad Locking arrangement.
- An extended Thumb Grip.
- Glass filled Thermoplastic Polymer exhibits better mechanical strength compared to other Plastic (PP)

Packaging & Pricing

Product Code	List Price (Rs)	Specification	No. of Flat Rods	Mounting Accessories	Catchers (NO.)	Pad Locking Arrangement	Standard Packing (Nos)	Master Packing (Nos)
P3PL06	930.00	Three Point Locking(Rod 900mm)	2	Yes	-	Yes	5	75
P3PL06-1250	995.00	Three Point Locking(Rod 1250mm)	2	Yes	-	Yes	5	75
P3PL05	POR*	Five Point Locking	2	Yes	4	Yes	5	75
P3PL07	POR*	Seven Point Locking	2	Yes	4	Yes	5	75

* POR - Price On Request

Three Point Lock - Metallic(Push Fit Type)

Product Description

Three Point Lock Metallic Body
Push Button Operated

Body Material
Aluminum Die Casting

Colour
Black



Packaging & Pricing

Product Code	List Price (Rs)	Specification	No. Of Rods	Mounting Accessories	Pad Locking Arrangement	Standard Packing (No.)	Master Packing (No.)
P3PL03	875.00	Without Rod & Accessories	No	No	NO	2	75
P3PL04	1225.00	With Accessories & Rod (1050mm)	2	Yes	NO	2	75
P3PL04-1250	1290.00	With Accessories & Rod (1250mm)	2	Yes	NO	2	75

Three Point Lock - Metallic(With Round Rods)

Product Description

Metallic 3 Point Lock with Round ROD
(Optional Pad Locking arrangement)

Body Material
Aluminum Die Casting

Colour
Black



NEW

Packaging & Pricing

Product Code	List Price (Rs)	Specification	No. Of Rods	Mounting Accessories	Pad Locking Arrangement	Standard Packing (No.)	Master Packing (No.)
P3PL10	900.00	Without Rod & Accessories	NO	NO	Yes	2	100
P3PL11	970.00	With Accessories, Without Rod	NO	Yes	Yes	2	100
P3PL12	1250.00	With Accessories & Rod (1050mm)	2	Yes	Yes	2	100
P3PL12-1250	1315.00	With Accessories & Rod (1250)	2	Yes	Yes	2	100

CANOPY LOCK

Product Description

Compression Type Canopey Lock

Body Material
Die Casting Duly Powder Coater

Colour
Black



NEW

Packaging & Pricing

Product Code	List Price (Rs)	Specification	Standard Packing (No.)	Master Packing (No.)
PCL01	962.00	Provides Ip54 Protection	2	50

Panel Lock 16mm

Product Description

Panel Lock 16mm

Material

Zinc Alloy Duly Power Coated with MS Lever

Chucknut/Catcher	Gasket	Insert	Key
MS Chrome Plated	EPDM	Square	Polyamide



NEW



Why PECOX?

- Powder Coated With Chrome plating reduces risk of corrosion.

Packaging & Pricing

Product Code	List Price (Rs)	Unit	Description	Standard Packing (Nos)	Master Packing (Nos)
PPL-S04	60.00	Nos	16mm Lock with chucknut	50	1200
PPL-SC	45.00	Nos	Catcher for Lock	50	1200
PPL-SH	20.00	Nos	Side handle	100	3000
PPLK-S04	30.00	Nos	Key for Lock	100	2400

Latch Type/DB Lock

Product Description

Latch Type/DB lock for Distribution Boxes & MCB enclosures

Material

Engineering Grade Thermoplastic

Color

RAL 7035(Grey), Black, Dark Grey



Why PECOX?

- Preeminent spring quality.
- The Moulding architecture provides proper gripping
- Provision for " Name Engraving" on the top against Standard MOQ,

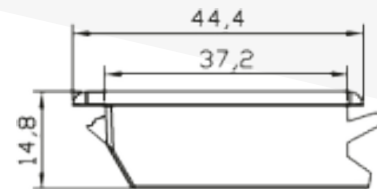
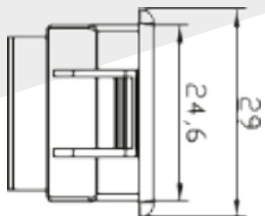

Packaging & Pricing

Product Code	List Price (Rs)	Unit	Cut-Out Size (mm x mm)	Color	Standard Packing (Nos)	Master Packing (Nos)
PDB01	13.00	Nos	37.2 x 24.6	Grey 7035	100	3000
PDB01 DG	13.00	Nos	Catcher for Lock	Dark Grey	100	3000
PDB01N	13.00	Nos	Side handle	Black	100	3000

Self Adhesive Foam Gasket

Product Description

Self Adhesive Foam Gasket

Material
EVA Foam

Color
Black



Why PECOX?

➤ Strong Adhesive.



Packaging & Pricing

Product Code	List Price (Rs)	Unit	Specification	Standard Packing (Nos)	Master Packing (Nos)
PAG0310	35.49	Roll=10 Mtr	10mm x 3mm	30	360
PAG0312	42.36	Roll=10 Mtr	12mm x 3mm	30	360
PAG0315	52.68	Roll=10 Mtr	15mm x 3mm	15	180
PAG0318	64.10	Roll=10 Mtr	18mm x 3mm	15	180
PAG0320	70.98	Roll=10 Mtr	20mm x 3mm	15	180
PAG0325	88.72	Roll=10 Mtr	25mm x 3mm	12	144
PAG0330	106.47	Roll=10 Mtr	30mm 3mm	10	120
PAG0340	142.27	Roll=10 Mtr	40mm x 3mm	7	84
PAG0518	49.29	Roll=5 Mtr	18mm x 5mm	15	180
PAG0520	57.31	Roll=5 Mtr	20mm x 5mm	15	80
PAG0525	68.17	Roll=5 Mtr	25mm x 5mm	12	144
PAG0540	109.36	Roll=5 Mtr	40mm x 5mm	7	84

Product Code	List Price (Rs)	Unit	Description	Standard Packing (Nos)	Master Packing (Nos)
PHN-SH40	27.60	Nos	MS Single Hole 40 mm	100	600
PHN-DH40	28.75	Nos	MS Double Hole 40mm	100	600

Description - Concealed Hinge
Material - MS Zinc passivized



Product Code	List Price (Rs)	Unit	Description	Standard Packing (Nos)	Master Packing (Nos)
PHN-DH55	33.00	Nos	MS Double Hole 55 mm	100	600
PHN-DH60	48.40	Nos	MS Double Hole 60 mm	50	300
PHN-DH-90	88.55	Nos	MS Double Hole 90 mm	50	300



Product Code	List Price (Rs)	Unit	Description	Standard Packing (Nos)	Master Packing (Nos)
PHN-DB1	31.63	Nos	MS DB Hinge	100	1000



Product Code	List Price (Rs)	Unit	Description	Standard Packing (Nos)	Master Packing (Nos)
PHNU20	23.00	Nos	MS U Type Hinge for 20 mm Depth	50	1000
PHNU25	25.30	Nos	MS U Type Hinge for 25 mm Depth	50	1000

Description - U-type Hinge
Material - MS Zinc passivized



Product Code	List Price (Rs)	Unit	Description	Standard Packing (Nos)	Master Packing (Nos)
PHNUS	34.50	Nos	MS U Type Hinge for 20 mm Depth	50	1000



Material - Zinc Die Casted

Product Code	List Price (Rs)	Unit	Description	Standard Packing (Nos)	Master Packing (Nos)
PHN-DB2	26.45	Nos	Die Casted Male / Female DB Hinge	100	1000



Product Code	List Price (Rs)	Unit	Description	Standard Packing (Nos)	Master Packing (Nos)
PHN-05	50.60	Nos	Die Casted Concealed Hinge	50	1000



Product Code	List Price (Rs)	Unit	Description	Standard Packing (Nos)	Master Packing (Nos)
PHN-37	149.50	Nos	Die Casted Consealed Hinge 75mm	20	300



Material - Stainless Steel

Product Code	List Price (Rs)	Unit	Description	Standard Packing (Nos)	Master Packing (Nos)
PHN-19SQSS	408.25	Nos	Stainless Steel with Square hole	10	200



Product Description

Thermoelastic Grommets

Material

Engineering Grade Thermoelastic

Color

Black/Orange



Why PECOX?

- Thermo-Elastic material has a property to reshape and compressed down post the wire is inserted making the panel dust proof.

Packaging & Pricing

Product Code	List Price (Rs)	Unit	Suitable for Hole Dia (mm)	Standard Packing (Nos)	Master Packing (Nos)
PGR50	POR*	Nos	50mm	100	2000

* POR - Price On Request

Snap Fit Grommets

Product Description

Snap Fit Gormmets With Optional Center knockout

Material

Engineering Grade Thermoplastic

Gasket

EPDM

Color

RAL 7035(Grey)



Why PECOX?

- It's Open & Close type grommet, with breakable center knockout (press & break from the center as when required).
- EPDM gasket to maintain Ip54 degree protection.
- Compatible with both 1.6 mm & 2mm thick Panel Sheet.
- No- "Wear & Tear" due to environment as compared to rubber grommet.

Packaging & Pricing

Product Code	List Price (Rs)	Unit	Suitable for Hole Dia	Standard Packing (Nos)	Master Packing (Nos)
PGS10	3.00	Nos	10 mm	500	20000
PGS22	6.00	Nos	22 mm	100	5000
PGS25	6.00	Nos	25 mm	100	5000
PGS32	6.50	Nos	32 mm	100	2500
PGS38	7.50	Nos	38 mm	100	2000
PGS50	10.00	Nos	50 mm	100	1000

Panel Door Handles

Product Description

Panel Door Handle
(With Insert/Without Insert)

Material

Engineering Grade Thermoplastic

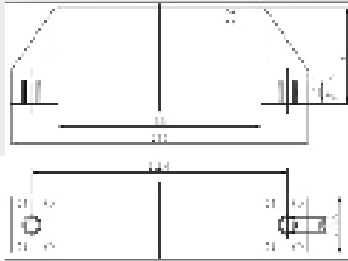

Why PECOX?

- Insert have been provided to have an inter-locking
- Designed for proper gripping & handling.

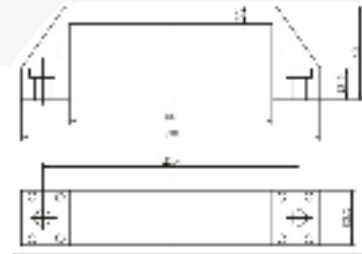

Packaging & Pricing

Product Code	List Price (Rs)	Unit	Specification	Standard Packing (Nos)	Master Packing (Nos)
PDH	30.00	Nos	Handle Without Insert	40	480
PDH-I	44.00	Nos	Handle With Insert	40	480

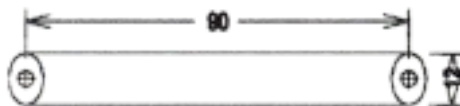

Product Code	List Price (Rs)	Unit	Specification	Standard Packing (Nos)	Master Packing (Nos)
PDH90	12.50	Nos	C to C - 90mm	100	1200

Pocket handles

Product Description

Snap Fit Pocket Handle(Flush)

Material

Engineering Grade Thermoplastic

Gasket

Color

EPDM Black & Grey(RAI 7035)

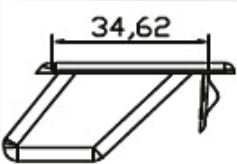

Why PECOX?

- EPDM Gasket to maintain Ip54 degree protection.
- Extra depth for perfect gripping

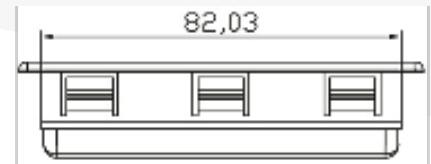

Packaging & Pricing

Product Code	List Price (Rs)	Unit	Cutout Size (mm x mm)	Color	Standard Packing (Nos)	Master Packing (Nos)
PDPH	22.00	Nos	82.03 X 34.62	Grey	480	480
PDPHN	22.00	Nos	82.03 X 34.62	Black	480	480

Product Description

Screw Knobs(Pointed)

Material

Polyamide head With MS Hexagonal

Bolt (Zinc Plated) Moulded

Locking washer

PVC

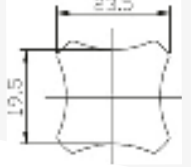
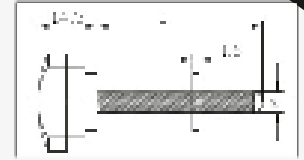

Why PECOX?

- Screw Knobs are moulded with Hexagonal Bolt to provide perfect grip (No Threaded Rod is used).
- Top Lock/Head made up of Polyamide which makes it Unbreakable
- A unique designed PVC Washer is provided which can scale up & down quickly keeping the gripping perfect.

Packaging & Pricing

Product Code	List Price (Rs)	Unit	Specificaation		Standard Packing (Nos)	Master Packing (Nos)
			M	L (mm)		
PSK625	8.00	Nos	M6	25	100	3000
PSK632	8.40	Nos	M6	32	100	2600
PSK638	9.10	Nos	M6	38	100	2600

Product Description

Lifting Hook With Mounting Washers

Material

MS Sheet (Zinc Passivated)



Mounting

At Corners of Panel-frame, L-shape also available for mounting at center of panel-frame



Why PECOX?

- > A unique design, well tested to have a breaking load at 20.8 kN by Spectro Lab.
- > The centre punch is well crafted to make its internal edges smooth.
- > Mounting washers are provided for proper fastening.
- > Uniquely designed to be mounted on every corner of the Top Frame of the Panel
- > L-Shape is also provided for mounting in the centre of the frame, if required.
- > Soon "ST" type will be introduced for mounting at sides of the Panel.

Packaging & Pricing

Product Code	List Price (Rs)	Unit	Sheet Thickness	Specification			Mounting Holes Dia	Standard Packing (Nos)	Master Packing (Nos)
				Center punch	Load Bearing Capacity				
PLH50/PLH50L	86.90	Nos	5mm	50mm	19KN	-	12mm	20	120
PLH38/PLH38L	68.20	Nos	4mm	38mm	-	-	10mm	30	180
PLH25/PLH25L	53.90	Nos	3mm	25mm	-	-	8mm	40	240

Finger Contact

Product Description

Finger Contacts for Output Connections

Material

Brass (Tinned Plated)



Why PECOX?

- > Finger Contacts can be used as SPREADER LINK for Input connections from the Bus Bars/MCB/Contactors to control circuit with help of snap type Lugs

Packaging & Pricing

Product Code	List Price (Rs)	Unit	Specification		Standard Packing (Nos)	Master Packing (Nos)
			Bolt Size	No of Output		
PFC02	18.60	Nos	M8	2	100	-
PFC03	21.00	Nos	M12	3	100	-

Neutral Link-Base Mounting

Product Description

Base Mounting Neutral Link

Material

Engineering Grade Glass Filled
Thermoplastic base With Brass Contacts

Color

Black & Red

Contact Finish

Tinned



Why PECOX?

- ▶ PNL16/32/63, Uniqually designed with extended side guards, so that the Sliding Bar do not short to other links during operation.
- ▶ No current leakage since Glass filled Thermoplastic is adverse to moisture or humidity.
- ▶ Double hole mounting also available in 16A & 32A.

Note : For **FR** grade, Price will be 20% Extra with MOQ (Color : Golden Yellow)

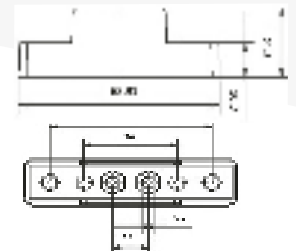
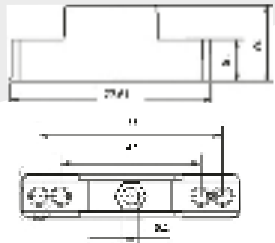

Packaging & Pricing

Product Code	List Price (Rs)	Unit	Specification Current Capacity	Standard Packing (No.)	Master Packing (Nos)
PNL16	41.00	Nos	16 Amps	60	1020
PNL16DH	45.00	Nos	16 Amps	60	1020
PNL32	45.00	Nos	32 Amps	60	1020
PNL32DH	50.00	Nos	32 Amps	60	1020
PNL63	130.00	Nos	63 Amps	30	450
PNL100	205.00	Nos	100 Amps	20	300

Neutral Link - Channel Mounting

Product Description

Din Rail Mounting Neutral Link Body

Material

Engineering Grade Thermoplastic Body

Color

Black



PKNL 32

PKNL 63

PKNL 125/200/250



Why PECOX?

- ▶ A new concept replacing the traditional design, reducing the labor cost & time by simply making snapfit on din rails.
- ▶ PKNL125-250 have additional Unique Feature of universal mounting arrangement on both Rails also on surface.

Packaging & Pricing

Product Code	List Price (Rs)	Unit	Specification Current Capacity	Contacts Materials	Standard Packing (Nos)	Master Packing (Nos)
PKNL16	44.50	Nos	16 Amps	Brass	50	800
PKNL32	46.25	Nos	32 Amps	Brass	50	800
PKNL63	121.25	Nos	63 Amps	Brass	30	480
PKNL125	PDR	Nos	125 Amps	brass	10	200
PKNL200	PDR	Nos	200 Amps	Brass	10	200
PKNL250	PDR	Nos	250 Amps	Brass	10	200

Product Description

Neutral Bars With Bases

Material

Base: Engineering Grade Glass Filled Thermoplastic

Bars: Brass with MS Zinc Screws

Base Color

Black, White & Red



Packaging & Pricing

Product Code	List Price (Rs)	Current Rating	Screw Size	Number of Ways	Standard Packing (smps)	Master Packing
PELB163205	20.82	16-32Amps	M3	5	100	-
PELB163207	29.10	16-32Amps	M3	7	100	-
PELB163209	37.44	16-32Amps	M3	9	100	-
PELB163213	54.14	16-32Amps	M3	13	100	-
PELB163217	70.71	16-32Amps	M3	17	100	-
PELB3205	39.97	32Amps	M4	5	50	-
PELB3207	55.97	32Amps	M4	7	50	-
PELB3209	71.97	32Amps	M4	9	50	-
PELB3213	103.98	32Amps	M4	13	50	-
PELB3217	135.98	32Amps	M4	17	50	-
PELB3237	296.01	32Amps	M4	37	20	-
PELB6309	115.24	63Amps	M5	9	50	-
PELB6313	166.47	63Amps	M5	13	50	-
PELB6317	217.58	63Amps	M5	17	50	-
PELB6337	473.11	63Amps	M5	37	20	-
PELB10013	312.46	100Amps	M6	13	20	-
PELB10017	407.33	100Amps	M6	17	20	-
PELB10037	888.03	100Amps	M6	37	20	-

Neutral Base

PELB-B2



PELB-3810



Product Code	List Price (Rs)	Unit	Suitability	Mounting Hole	Standard Packing	Master Packing
PELB-B2	7.50	Nos	For 32-100 Amp Neutral Bar	M4	100	3000
PELB-3810	8.50	Nos	For 16/32 Amp Neutral bar	M4	100	9000
PELB-3710	8.50	Nos	For 16/32 Amp Neutral Bar	M4	100	9000
PELB-3709	8.50	Nos	For 16/32 Amp Neutral Bar	M4	100	9000

Product Description

Standard Connection Plates

Material

Engineering Grade Glass Filled Thermoplastic

Colour

Pecox - White
P-Konnect - Red

Caps

As per International Standards

PTPN100



PTPN63



PKTPN63



PTP63



PDP63



Why PECOX?

- No current leakage since Glass filled Thermoplastic is adverse to moisture or humidity.
- Glass filled material exhibits excellent mechanical strength making it more rigid and strong.
- Balanced mounting design avoids breakage due to excessive Weight of cable.
- Hexagonal mounting arrangements speeds up the fixing/mounting process

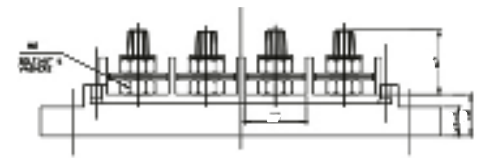
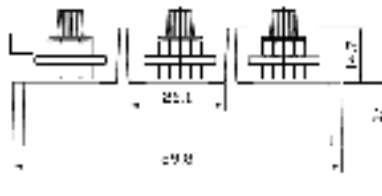
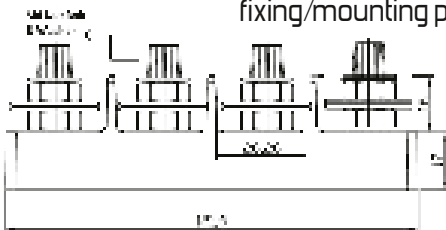

PTPN63/PKTPN63

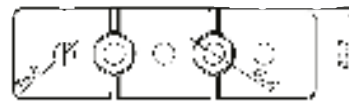
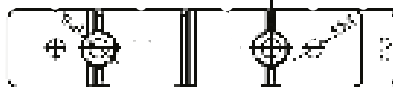

PTP63

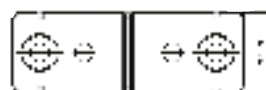
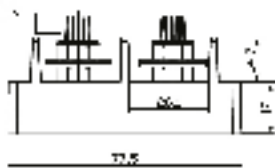

PDP63

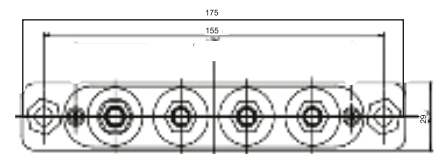

PTPN100

Packaging & Pricing

Product Code	List Price (Rs)	Current Rating	Number of Poles	Bolt Specs	Mounting Hole (C to C) (mm)	Standard Packing (Nos)	Master Packing (Nos)
PDP63	52.50	63Amps	2	M6	59	50	600
PTP63	60.00	63Amps	3	M6	29.5	45	540
PTPN63	70.00	63Amps	4	M6	59	30	360
PKTPN63**	52.00	63Amps	4	M6	59	30	360
PTPN100	107.00	100Amps	4	M8	155	7	210

** "P-konnet" - Brand, An "Economical" Series of Pecox.

For FR grade, 20% extra Price will be charged with MOQ (color - Golden Yellow)

Product Description

Standard Connection Plates with Protection Cover

Material

Engineering Grade Glass Filled Thermoplastic

Colour

Base - White

Cover - Transparent (Clear)

Caps - As Per International Standards



PTSB4



PTSB6



Why PECO X?

- No current leakage since Glass filled Thermoplastic is adverse to moistures or humidity.
- Glass filled material exhibits excellent mechanical strength making it more rigid & strong.
- Balanced mounting design avoids breakage due to weight of cable.
- Hexagonal mounting arrangements speeds up the fixing/mounting process
- Polycarbonate Protection Cover is unbreakable & UV Stabilized thus preventing from tanning to yellow.

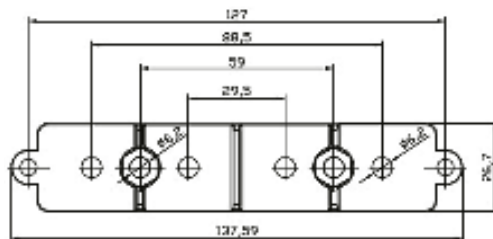
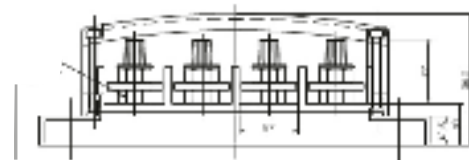
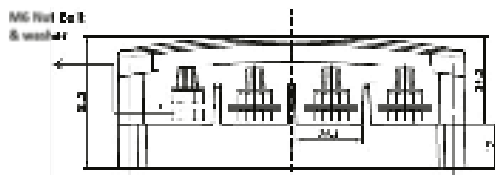

PTSB4

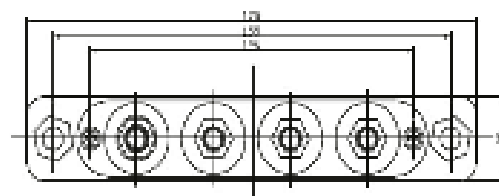

PTSB6

Packaging & Pricing

Product Code	List Price (Rs)	Current Rating	Number of Poles	Bolt Specs	Mounting Hole (C to C) (mm)	Protection Cover Material	Standard Packing Nos	Master Packing Nos
PTSB4C	103.00	63 Amps	4	M6	59	Crystal	15	180
PTSB4P	116.00	63 Amps	4	M6	59	Polycarbonate (UV Stabilized)	15	180
PTSB6C	140.00	100 Amps	4	M8	155	Crystal	5	140
PTSB6P	154.00	100 Amps	4	M8	155	Polycarbonate (UV Stabilized)	5	140

Note : For FR grade, 20% extra Price will be charged with MOQ (color - Golden Yellow)

Product Description

HRC Fuse Holder

Body Material

Engineering Grade Glass Filled Thermoplastic

Contact Material

Moving - Phosphorus Bronze (Pb)

Fix - Nickel Plated Brass

Color

Black/Grey(RAL 7035)



Why PECOX?

- "Pb Contact" exhibits better spring action(zero chances of losing Contact).
- "Glass Filled Polyamide" adverse to moisture thus "Zero Current leakage"

Packaging & Pricing

Product Code	List Price (Rs)	Unit	Specification	Standard Packing (Nos)	Master Packing (Nos)
PFH2032	128.00	Nos	20-32 Amps	25	500

Indicating Lights

Product Description

Led Indicating Lights

Material

Engineering Grade thermoplastic



Why PECOX?

- PICL - 22M Provides Multi-voltage option, reducing Inventory.

Packaging & Pricing

Product Code	List Price (Rs)	Unit	Size	Voltage	Color	Standard Packing (Nos)	Master Packing (Nos)
PILL-16	C	Nos	16mm	220VAC	R, Y, G	20	500
					B, W	20	500
PILL-22	M	Nos	22.5mm	220VAC	R, Y, G	20	500
					B, W	20	500
PILC-22	G	Nos	22.5mm	220VAC	R, Y, G	20	500
					B, W	20	500
PILC-22M	O	Nos	22.5mm	MULTI-VOLATGE 12VDC -24VDC 110VAC -220VAC	R, Y, G	20	500
					B, W	20	500

Product Description

MCB Shorting Insulated Comb Bus Bars

Material

Electrolytic Copper Duly Tinned Plated
Insulated with PVC Section

Color

Light Grey



Why PECOX?

- ▶ Comb bus bars are tinned plated to prevent from oxidization .
- ▶ Pvc Insulation Provide Protection form any shock & unforeseen events.
- ▶ Electrolytic Grade of Copper provide better conductivity.



Packaging & Pricing

Product Code	List Price (Rs)	Unit	Type of MCB	Specifications No. of MCB Shorting	Current Rating	Standard Packing (Mtr)	Master Packing (Mtr)
PMSP-P	1134.71	Mtr	Single Pole Pin	57	63 Amps	50	-
PMSP-U	1186.28	Mtr	Single Pole Fork	28	63 Amps	24	-
PMDP-P/U	2139.37	Mtr	Double Pole	19	63 Amps	20	-
PMTP-P/U	3409.18	Mtr	Three Pole	14	63 Amps	12	-
PMFP-P/U	4383.23	Mtr	Four Pole				

TIE Mounts

Tie Mounts

Product Code	List Price (Rs)	Unit	Specification	Standard Packing (Nos)	Master Packing (Nos)
PMT19	3.80	Nos	19x19	100 Nos	1800
PMT25	5.00	Nos	25x25	100 Nos	6000



Tie Mounts - Ladder Type

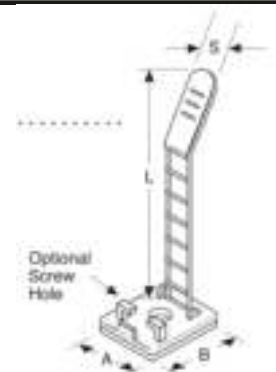

Product Code	List Price (Rs)	Unit	Height (mm)	Weight (mm)	length (mm)	Depth (mm)	Standard Packing (Nos)	Master Packing (Nos)
PTM-L1	7.93	Nos	20	29	84	12.4	100	1800

Tie Mounts - Flat Adhesive

Product Code	List Price (Rs)	Unit	Height (mm)	Weight (mm)	length (mm)	Depth (mm)	Standard Packing (Nos)	Master Packing (Nos)
PTM-F1	6.61	Nos	144	24.7	29.7	7	100	1800



Product Description

Conical Insulator

Material

Body: Engineering Grade Glass Filled Thermoplastic

Inserts Construction

MS(Hexagonal Grooved)

Color
Red



Why PECOx?

- Strategic Design based on combination of Multi Fold Technique Ribs & Gussets which has revolutionized Insulators segment by delivering more STRENGTH and economical too.
- Glass filled Thermoplastic exhibits excellent mechanical & Dielectric strength making it more rigid and strong as compared to Thermoset material.
- No current leakage Since Glass filled Thermoplastic is adverse to moistures or humidity.
- Hexagonal Multi Grooved inserts accelerates better gripping as compared to round ones.
- Insert Pull Out at force of 5.6 kN, tested by Spectro lab calibrated at 50 ton U.T.M.

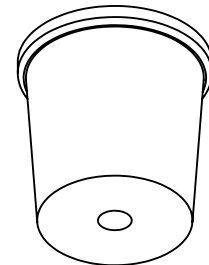
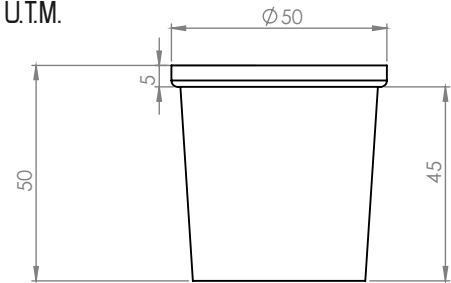
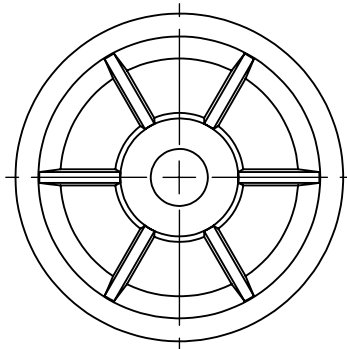
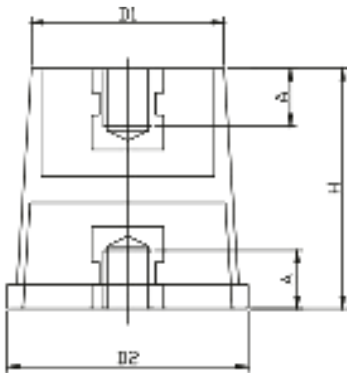

Technical Datasheet, Pricing & Packaging

Product Code	List Price (Rs)	Unit	Dimension			Insert Thread Length (A)		Standard Packing	Master Packing
			D1	D2	H	(mm)			
PKB1625C**	20.24	Nos	20	25	25	M6	10	60	1800
PKB1630C**	18.75	Nos	25	30	30	M6	10	60	1800
PKB1840C**	33.75	Nos	33	40	40	M8	12	60	960
PKB11050C**	57.5	Nos	40	50	50	M10	14	60	360

** "P-konnet" - Brand, An "Economical" Series of Pecox.

Product Description

Hexagonal Insulator

Material

Body: Engineering Grade Glass Filled Thermoplastic

Inserts Construction

MS(Hexagonal-Multi Grooved)

Color
White



Why PECO?

- Strategic Design based on combination of Multi Fold Technique AND Ribs & Gussets which has revolutionized Insulators segment by delivering more STRENGTH and economical too.
- Glass filled Thermoplastic exhibits excellent mechanical & Dielectric strength making it more rigid and strong as compared to Thermoset material. For Technical comparison of raw material. Refer page No-
- No current leakage Since Glass filled Thermoplastic is adverse to moisture or humidity.
- Hexagonal Multi Grooved inserts accelerates better gripping as compared to round ones.
- High Voltage 3.3KV Passed & Tested by CPRI, Noida Report No- CPRI RT LHV2017 T102.
- Insert Pull Out at force of 5.6 KN, tested by Spectro lab calibrated at 50 ton U.T.M.
- Hexagonal design is Compatible for Wrench / Spanner operation for easy fitting/tightening
- Also Available in **FR LS ZH** Material at EXTRA COST.

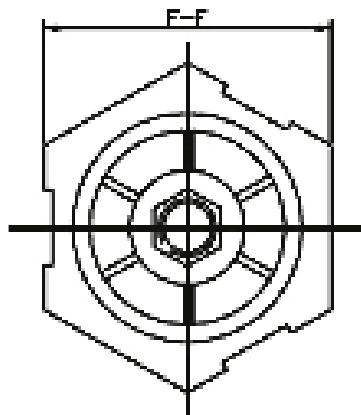
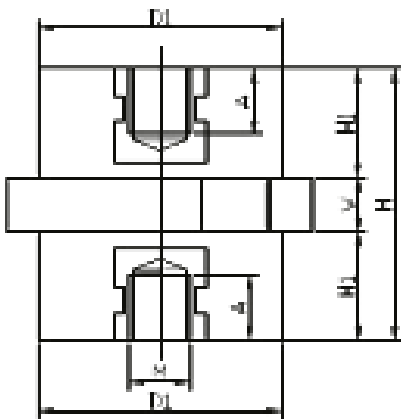

Packaging & Pricing

Product Code	List Price (Rs)	Unit	Dimension					Insert Thread Length (A) (mm)	Standard Packing Nos	Master Packing Nos	
			D1	(FF)	H	H1	W				
PBI415H	25.00	Nos	11.5	14	15	5.5	4	M4	5	100	2000
PBI630H	35.00	Nos	26	30	30	11	8	M6	10	50	1500
PBI830H	45.00	Nos	26	30	30	11	8	M8	12	50	1500
PBI840H	62.50	Nos	40	45	40	15.25	9.5	M8	12	45	540
PBI1050H	90.00	Nos	40	50	50	20	10	M10	14	60	360

Product Description

P-Series Insulator (PeCox - Patented Design) is PYRAMID shaped Spanner Operated design

Material

Engineering Grade Glass Filled Thermoplastic

Color

Off white (Natural)



Inserts Constructions

MS (Multi Grooved - Hexagonal)



Why PECOX?

- Based on the fundamental of Civil & Electrical engineering.
- It can be fitted/ tighten well with the Spanners.
- Glass filled Thermoplastic exhibits excellent mechanical & Dielectric strength making it more rigid and strong as compared to Thermoset material. For Technical comparison of raw material.
- No current leakage Since Glass filled Thermoplastic is adverse to moisture or humidity.

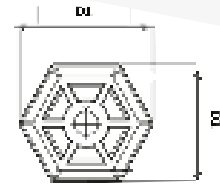
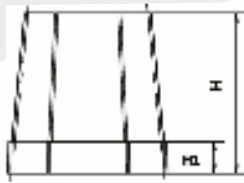

Packaging & Pricing

Product Code	List Price (Rs)	Unit	D1	Dimension D2	H1 mm	H	Insert Size Length	Suggested Spanner Size	Standard Packing (Nos)	Master Packing (Nos)
PBI415P	24.00	Nos	14	13	4	15	M4	5	100	2000
PBI625P	30.00	Nos	25	22	6	25	M6	8	60	1680
PBI630P	30.00	Nos	29	26	6	30	M6	8	60	1680
PBI830P	40.00	Nos	29	26	6	30	M8	10	60	1680
PBI840P	45.00	Nos	41	36	8	40	M8	10	45	540
PBI1050P	70.00	Nos	50	43	10	50	M10	12	60	300

L Support

Product Description

L Type Support

Material

Engineering grade Glass Filled Thermoplastic

Color

Off White (Natural)

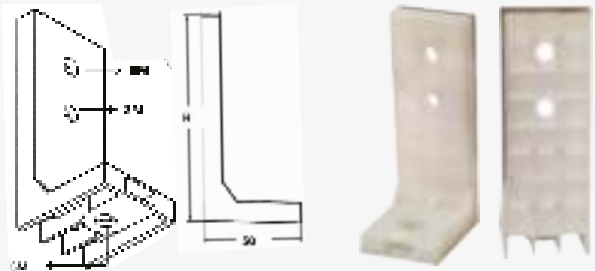

Why PECOX?

- L- Supports are so Uniquely designed that a Hexagonal mounting hole has been provided on base & two holes have been provided for Bus Bars mounting, both saves labour cost.
- Also Available in **FR LS ZH** Material at EXTRA COST.

Packaging & Pricing

Product Code	List Price (Rs)	Unit	Specifications (H)	Standard Packing (Nos)	Box Packing (Nos)
PLS85	38.50	Nos	L Support 85 mm	40	480
PLS105	50.00	Nos	L Support 105 mm	40	480
PLS125	58.00	Nos	L Support 125 mm	40	480

Product Description

Single Pole Support System

Material
Engineering Grade Glass Filled Thermoplastic

Color
Off white (Natural), Red, Yellow, Blue, & Black

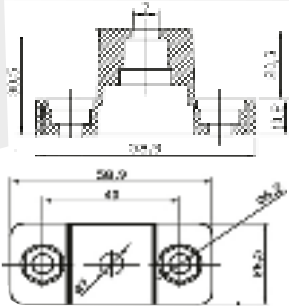

PSP-30



Why PECOX?

- Glass filled Thermoplastic exhibits excellent mechanical & Dielectric strength making it more rigid and strong as compared to Thermoset material.
- No current leakage Since Glass filled Thermoplastic is adverse to moisture or humidity.
- Hexagonal Mounting Arrangements for speedy fixing.

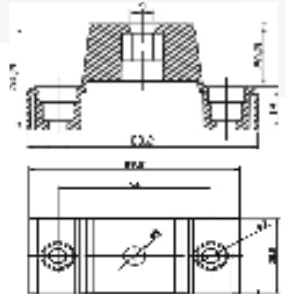

PSP-35

Packaging & Pricing

Product Code	List Price	Unit	Specification	Standard Packing (Nos)	Master Packing (Nos)
PSP30	12.50	Nos	Single Support 30mm Height (Natural Color)	90	1680
PSP30R/Y/B/N	14.00	Nos	Single Support 30mm Height (Red/yellow/Blue/Black)	90	1680
PSP35	25.00	Nos	Single Support 35mm Height (Natural Color)	70	350
PSP35R/Y/B/N	30.00	Nos	Single Support 35mm Height (Red/yellow/Blue/Black)	70	350

Grip Type Support (Snap-Fit Type)

Product Description

Grip Type Support for Vertical Bus Bar Mounting

Material
Engineering grade Glass Filled Thermoplastic

Color
Off White (Natural)



Why PECOX?

- Glass filled Thermoplastic exhibits excellent mechanical & Dielectric strength making it more rigid and strong
- No current leakage since Glass Filled Thermoplastic is adverse to moisture or humidity
- Snap Fit design Saves Labour Cost.
- Also Available in **FR LS ZH** Material at EXTRA COST.

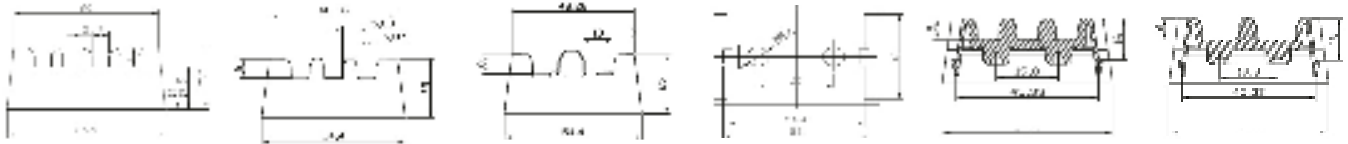

Packaging & Pricing

Product Code	List Price (Rs)	Specifications	Mounting Dimensions (mm) Hole (C to C)	Mounting Dimensions (mm) Slots (C to C)	Standard Packing Nos	Master Packing Nos
PAGP407	41.25	6mmx 4 run	30	54.4	60	720
PAGP307	38.50	6mmx 3run	20	45.3	60	720
PAGP210	38.50	10mmx 2 run	20	45.3	60	720

Product Description

FR Grade Ferruling Sleeves/Printing Sleeves

Material
PVC

Color
White
Yellow(Optional)



Why PECOX?

- Flame Retardant grade V2 tested by Spectro Labs RoHS No. N180530010.
- Box Packing refrains sleeves from being tangled & also protects from dust & other particles.
- Ferruling Sleeves Comply to RoHS directives.

Packaging & Pricing

Product Code	List Price (Rs)	Unit	Description	Standard Packing (Per Box)	Master Carton (Per Box)
PPT2.5	454.00	100 Mtr	Suitable for 0.5 sqmm wire	100 Mtr	22
PPT3.2	509.00	100 Mtr	Suitable for 0.75/1.0 sqmm wire	100 Mtr	22
PPT3.5	532.00	100 Mtr	Suitable for 1/1.5 sqmm wire	100 Mtr	22
PPT4.2	655.00	100 Mtr	Suitable for 2.5 sqmm wire	100 Mtr	22
PPT5.2	730.00	100 Mtr	Suitable for 4 sqmm wire	100 Mtr	22
PPT5.5	813.00	100 Mtr	Suitable for 4/6 sqmm wire	100 Mtr	22
PPT6	565.00	50 Mtr	Suitable for 6 sqmm wire	50 Mtr	22
PPT7	875.00	50 Mtr	Suitable for 10 sqmm wire	50 Mtr	22

Spiral

Product Description

Spiral sleeves for Wrapping wires

Material
PVC

Color
Grey (RAL 7035)
White (Optional)



Why PECOX?

- Spirals are heavy duty and Comply to RoHS directives.
- FR Grade is also available at EXTRA COST.

Packaging & Pricing

Product Code	List Price (Rs)	Unit	Description		Standard Packing (Per Roll)	Master Packing (Roll)
			O. D (mm)	Thickness (mm)		
PSW6	245.00	Roll	6	0.5 ± 5	50 Mtr	50
PSW9	245.00	Roll	9	0.5 ± 5	25 Mtr	50
PSW12	410.00	Roll	12	0.6 ± 5	25 Mtr	20

Self-Locking Non-Releasable Cable Tie

Product Description

Self Locking Non-Releasable Cable Ties

Material

Pa66

Operating Temperature

-30°C To +85°C

Color

Black & White



Why PECOX?

- **Low Smoke Halogen Free (LSZH)** cable ties makes very low levels of smoke and toxic fumes when burnt.
- **Ziplock Packing** stabilizes the hydrophobicity impact on cable ties helps in retaining the moisture during storage for later use making the cable ties flexible for installation.

Standard Size

Product Code	Nominal Overall Length (mm)	Strap Width (mm)	Max Bundle Cable Dia (mm)	Min Loop Tensile Strength Kgf	Min Loop Tensile Strength lbs	Standard Packing (Nos)	Master Packing (No. Of Pkts)	List Price (Rs.)
PCT10025	100	2.5	20	8	18	1000	65	515.30
PCT10025S	100	2.5	20	8	18	100	500	55.77
PCT15036	150	3.6	35	18	40	100	250	131.75
PCT20036	200	3.6	35	18	40	100	200	165.01
PCT25048	250	4.8	60	22.7	50	100	130	275.98
PCT30048	300	4.8	75	22.7	50	100	100	361.46
PCT40048	400	4.8	100	23	50	100	90	514.34
PCT45048	450	4.8	100	23	50	100	90	562.47
PCT10025SUV	100	2.5	20	8	18	100	500	60.97
PCT15036UV	150	3.6	35	18	40	100	250	144.52
PCT20036UV	200	3.6	35	18	40	100	200	181.08
PCT25048UV	250	4.8	60	22.7	40	100	130	302.93
PCT30048UV	300	4.8	75	22.7	50	100	100	396.92
PCT45048UV	450	4.8	100	23	50	100	90	617.85

ECO SIZE

Product Code	Nominal Overall Length (mm)	Strap Width (mm)	Max Bundle Cable Dia (mm)	Min Loop Tensile Strength Kgf	Min Loop Tensile Strength lbs	Standard Packing (Nos)	Master Packing (No. Of Pkts)	List Price (Rs.)
PCT10022	100	2.2	20	8	18	1000	80	339.07
PCT10022S	100	2.2	20	8	18	100	80	38.13
PCT15022	150	2.2	35	8	18	100	50	58.89
PCT15030	150	3	35	18	40	100	230	78.77
PCT20030	200	3	35	18	40	100	200	115.06
PCT25040	250	4	60	23	50	100	150	209.84
PCT30040	300	4	75	23	50	100	125	241.70
PCT30040UV	300	4.8	75	23	50	100	125	265.22

Product Description

LV Grade Heat Shrinkable Bus Bar PVC Sleeves

Material

PVC

Standard Color

Red, Yellow, Blue, Black, & Green



Why PECOX?

➤ Heat Shrinkable Bus Bar Sleeves Complies to RoHS directives tested by SGS.

Packaging & Pricing

Product Code	List Price (Rs)	Unit	Suitable for Bus Bar (Size in mm)	Standard Packing (Nos)	Lay Flat Size In mm
PHS 15	12.27	Per Mtr	6x4, 6x6	50 Mtr	15
PHS 17	12.27	Per Mtr	10x3	50 Mtr	17
PHS 20	10.78	Per Mtr	12X3, 10X6	50 Mtr	20
PHS 25	10.63	Per Mtr	15X3, 12X6	50 Mtr	25
PHS 30	12.01	Per Mtr	20X3, 18X6, 16X3	50 Mtr	30
PHS 35	12.32	Per Mtr	25X3, 20X6	50 Mtr	35
PHS 41	14.17	Per Mtr	25X6, 25X9	50 Mtr	41
PHS 48	16.79	Per Mtr	30X10, 30X6, 25X12	50 Mtr	48
PHS 55	18.94	Per Mtr	38X6, 30X12	50 Mtr	55
PHS 61	21.10	Per Mtr	40X10, 40X6, 38X12, 38X9	50 Mtr	61
PHS 73	25.56	Per Mtr	50X6	50 Mtr	73
PHS 81	28.03	Per Mtr	50x12, 50x10	50 Mtr	81
PHS 93	32.34	Per Mtr	75x6	50 Mtr	93
PHS 103	37.88	Per Mtr	75x12	50 Mtr	103
PHS 110	40.35	Per Mtr	90x2, 90x6	50 Mtr	110
PHS 128	46.97	Per Mtr	100x9, 100x6	50 Mtr	128
PHS 140	51.28	Per Mtr	100x12	50 Mtr	140
PHS 170	62.68	Per Mtr	125x10, 125x6	50 Mtr	170
PHS 190	69.92	Per Mtr	150x12, 150x10, 150x6	50 Mtr	190
PHS 210	77.31	Per Mtr	175x12, 175x10, 175x6	50 Mtr	210
PHS 230	84.39	Per Mtr	2000x12	50 Mtr	230

Technical Parameters

Sr. No.	Description	Test Method	Results
1.	Working Temperature	-----	94.73 °C
2.	Dielectric Strength	ASTM D 149	15 kV/mm
3.	Insulation Resistance	-----	20x10
4.	Tensile Strength	ASTM D 638	397 kg/cm ²
5.	Ultimate Elongation	ASTM D 638	12.1%
6.	Shrinking Temperature	ASTM E 28	150- 155 °C
7.	Thickness of sleeve	ASTM D 1000	0.16mm



Format No: SALLGN/TRF/GEN
Issue No:01, Issue Date: 01-04-2017
Page 1 of 4

TEST REPORT

Test Report Issued To:

PECOX INTERNATIONAL

E-66, 2ND FLOOR, SECTOR-9, NOIDA, UTTAR PRADESH, INDIA, 201301.

Test Report No: D180323033/D180323033-1
Date of Issue: 26-Mar-2018

Sample Receipt Date: 23-Mar-2018
Date of Start of Testing: 24-Mar-2018
Date of Completion of Test: 26-Mar-2018



Customer Relationship Number: 50206

Sample Description:
PECOX MAKE AIRVENT TYPE-PAV-04



Customer Reference No:

WO/PO No:

Kind Attention: MR ABHISHEK MAITRA
E-Mail: abhishekmaitra18@gmail.com Contact No: NA

Sample Condition:
Sample Quantity (Approx): Sample Size (Approx):
SAMPLE NOT DRAWN BY OUR LABORATORY. THE RESULTS RELATE ONLY TO THE ITEMS TESTED

Report issued by

Authenticity of report can be verified by mail at verification@spectrolab.in
This is a Digitally Signed Report and hence doesn't require Physical Signature.

Spectro Analytical Labs Limited S-1, GNEPIP, Surajpur Industrial Area, Phase-V, Kasna, Greater Noida-201308 (India)
Phone: +91-120-2341250/2341251 | URL: www.spectro.in | Email: care@spectro.in
BIS & DDA Approved, ISO 9001:2008, ISO 14001:2004 & OHSAS 18001:2007 Certified Laboratory
Please refer to our Website www.spectro.in for Terms & Condition



Format No: SALLGN/TRF/GEN
Issue No: 01, Issue Date: 01.04.17

TEST REPORT

Page 2 of 4
Report No. D180323033/D180323033-1

ID: D180323033-1

DEGREE OF PROTECTION: IP-54

PROTECTION AGAINST FIRST CHARACTERISTIC NUMERAL: IP5X

SL.NO.	TEST PARAMETERS	RESULTS	TEST METHOD
1	Protection against access to hazardous parts: (First characteristic Numeral 5) Test Condition: <ul style="list-style-type: none"> Dia of Rigid metal Wire:1 mm Length of Wire:100 mm Wire edges free from burrs Applied force:1N 	The wire does not penetrate through the opening of enclosure and adequate clearance was kept.	IEC 60529:2001
	Protection against solid foreign object : (First characteristic Numeral 5) Sample kept in the dust chamber with the dust volume 2kg/m ³ for duration of 8 hours	No ingress of dust found inside the EUT after the test.	

Analyst Signature



Authorised Signatory



TEST REPORT

Report No. : **MAN:EE:8550001176** DATE : 13/09/2017
8550001176

PECOX INTERNATIONAL
E-66, 2ND FLOOR
NOIDA-201301
INDIA

CONTACT PERSON: MR. VIVEK KOTHARI
THE FOLLOWING SAMPLE(S) WAS/WERE SUBMITTED AND IDENTIFIED BY/ON BEHALF OF THE CUSTOMER AS :
SAMPLE DESCRIPTION: PANEL FILTER 4 SNAP TYPE
COLOUR: RAL 7035
MATERIAL: ABS
REFERENCE NO.: PAV04
BUYER: PECOX INTERNATIONAL
COUNTRY OF ORIGIN: INDIA
SAMPLE RECEIVED ON: 05/09/2017
TEST(S) REQUESTED: ROHS 6E TESTING PERIOD : 06/09/2017 - 13/09/2017

CONCLUSION : Based on the performed tests on submitted sample(s), the results of Cadmium, Lead, Mercury, Hexavalent chromium, Polybrominated biphenyls (PBBs), Polybrominated diphenyl ethers (PBDEs) comply with the limits as set by RoHS Directive (EU) 2015/863 amending Annex II to Directive 2011/65/EU

Per Pro SGS India Pvt Ltd.

Authorized Signatory
Kapil Patil
(Asst. Manager- Chemical)

Email your Test Report Related Enquiries at Feedback.HL.T@sgs.com

JOE No. : 175800428

Page 1 of 7

Control No. 8555001232

This document is issued by the Company subject to its General Conditions of Service printed overleaf, available on request or accessible at <http://www.sgs.com/terms> and, for electronic format documents, subject to Terms and Conditions for Electronic Documents at www.sgs.com/terms_e-document.htm. Attention is drawn to the limitation of liability, indemnification and jurisdiction issues defined therein. Any holder of this document is advised that information contained herein reflects the Company's findings at the time of its intervention only and within the limits of Client's instructions, if any. The Company's sole responsibility is to its Client and this document does not exonerate parties to a transaction from exercising all their rights and obligations under the transaction documents. This document cannot be reproduced except in full, without prior written approval of the Company. Any unauthorized alteration, forgery or falsification of the content or appearance of this document is unlawful and offenders may be prosecuted to the fullest extent of the law. Unless otherwise stated the results shown in this test report refer only to the sample(s) tested and such sample(s) are retained for 30 days only.

SGS India Pvt. Ltd. Consumer and Retail, Plot no. 21, Sector 3, IIT Main Road, Gurgaon District, Haryana: 122050 (India) | (+91) 124 678 7900
Block 4, Corp. Off. SGS House, 4B, A.S. Marg, Vashi (West), Mumbai-400088 | (+91) 6640 8888 | (+91) 6640 8829

www.sgs.com
Member of the SGS Group (ISSS SA)



TEST REPORT

Report No. : **MAN:EE:8550001176** DATE : 13/09/2017
8550001176

Test result:

Test Item(s):	Unit	Results	MDL	Limit
		Sample -1		
Cadmium (Cd)	mg/kg	n.d.	5	100
Lead (Pb)	mg/kg	n.d.	5	1000
Mercury (Hg)	mg/kg	n.d.	5	1000
Hexavalent Chromium (CrVI)	mg/kg	n.d.	8	1000
Sum of PBBs	mg/kg	n.d.	-	1000
Monobromodiphenyl	mg/kg	n.d.	50	-
Dibromodiphenyl	mg/kg	n.d.	50	-
Tribromodiphenyl	mg/kg	n.d.	50	-
Tetrabromodiphenyl	mg/kg	n.d.	50	-
Hexabromodiphenyl	mg/kg	n.d.	50	-
Pentabromodiphenyl	mg/kg	n.d.	50	-
Heptabromodiphenyl	mg/kg	n.d.	50	-
Octabromodiphenyl	mg/kg	n.d.	50	-
Nonabromodiphenyl	mg/kg	n.d.	50	-
Decabromodiphenyl	mg/kg	n.d.	50	-
Sum of PBDEs	mg/kg	n.d.	-	1000
Monobromodiphenyl ether	mg/kg	n.d.	50	-
Dibromodiphenyl ether	mg/kg	n.d.	50	-
Tribromodiphenyl ether	mg/kg	n.d.	50	-
Tetrabromodiphenyl ether	mg/kg	n.d.	50	-
Pentabromodiphenyl ether	mg/kg	n.d.	50	-
Hexabromodiphenyl ether	mg/kg	n.d.	50	-
Heptabromodiphenyl ether	mg/kg	n.d.	50	-
Octabromodiphenyl ether	mg/kg	n.d.	50	-
Nonabromodiphenyl ether	mg/kg	n.d.	50	-
Decabromodiphenyl ether	mg/kg	n.d.	50	-

Notes:

- The maximum permissible limit is quoted from RoHS Directive (EU) 2015/863. IEC 62321 series is equivalent to EN 62321 series
http://www.conelec.eu/dyn/www/?p=104:30:1742232870351101:::FSP_ORG_ID_FSP_LANG_ID:1258637_25
- Test has been performed as per client's request.
- The result of Hexavalent Chromium (Cr(VI)) is "ND" as the result of Chromium (Cr) is "ND", and confirmation test of Hexavalent Chromium (Cr(VI)) is not required.
- If the Chromium (Cr) content is greater than the MDL of Hexavalent Chromium (Cr(VI)), confirmation test of Hexavalent Chromium (Cr(VI)) is required.

JOE No. : 175800428

Page 3 of 7

Control No. 8555001232

This document is issued by the Company subject to its General Conditions of Service printed overleaf, available on request or accessible at <http://www.sgs.com/terms> and, for electronic format documents, subject to Terms and Conditions for Electronic Documents at www.sgs.com/terms_e-document.htm. Attention is drawn to the limitation of liability, indemnification and jurisdiction issues defined therein. Any holder of this document is advised that information contained herein reflects the Company's findings at the time of its intervention only and within the limits of Client's instructions, if any. The Company's sole responsibility is to its Client and this document does not exonerate parties to a transaction from exercising all their rights and obligations under the transaction documents. This document cannot be reproduced except in full, without prior written approval of the Company. Any unauthorized alteration, forgery or falsification of the content or appearance of this document is unlawful and offenders may be prosecuted to the fullest extent of the law. Unless otherwise stated the results shown in this test report refer only to the sample(s) tested and such sample(s) are retained for 30 days only.

SGS India Pvt. Ltd. Consumer and Retail, Plot no. 21, Sector 3, IIT Main Road, Gurgaon District, Haryana: 122050 (India) | (+91) 124 678 7900
Block 4, Corp. Off. SGS House, 4B, A.S. Marg, Vashi (West), Mumbai-400088 | (+91) 6640 8888 | (+91) 6640 8829

www.sgs.com
Member of the SGS Group (ISSS SA)



TEST REPORT

Report No. : MAN:EE:8550001177 DATE : 13/09/2017

8550001177

PECOX INTERNATIONAL
E-66, 2ND FLOOR
NOIDA-201301
INDIA
CONTACT PERSON MR. VIVEK KOTHARI
THE FOLLOWING SAMPLE(S) WAS/WERE SUBMITTED AND IDENTIFIED BY/ON BEHALF OF THE CUSTOMER AS :
SAMPLE DESCRIPTION PANEL METER GLASS SNAP FIT 96X96
COLOUR TRANSPARENT
MATERIAL POLYCARBONATE
REFERENCE NO. PMG02
BUYER PECOX INTERNATIONAL
COUNTRY OF ORIGIN INDIA
SAMPLE RECD ON 05/09/2017 TESTING PERIOD : 06/09/2017 - 13/09/2017
TEST(S) REQUESTED ROHS 6E

CONCLUSION : Based on the performed tests on submitted sample(s), the results of Cadmium, Lead, Mercury, Hexavalent chromium, Polybrominated biphenyls (PBBs), Polybrominated diphenyl ethers (PBDEs) comply with the limits as set by RoHS Directive (EU) 2015/863 amending Annex II to Directive 2011/65/EU

Per Pro SGS India Pvt Ltd.

Authorized Signatory
Kapil Patil
(Asst. Manager- Chemical)
Email your Test Report Related Enquiries at Feedback.HLT@sgs.com

JOE No. : 1755800428 Page 1 of 7 Client No. 855001231

This document is issued by the Company subject to its General Conditions of Service printed overleaf, available on request or accessible at <http://www.sgs.com/terms> and, for electronic format documents, subject to Terms and Conditions for Electronic Documents at www.sgs.com/terms_e-document.htm. Attention is drawn to the limitation of liability, indemnification and jurisdiction issues defined therein. Any holder of this document is advised that information contained hereon reflects the Company's findings at the time of its intervention only and within the limits of Client's instructions, if any. The Company's sole responsibility is to its Client and this document does not exonerate parties to a transaction from exercising all their rights and obligations under the transaction documents. This document cannot be reproduced except in full, without prior written approval of the Company. Any unauthorized alteration, forgery or falsification of the content or appearance of this document is unlawful and offenders may be prosecuted to the fullest extent of the law. Unless otherwise stated the results shown in this test report refer only to the sample(s) tested and such sample(s) are retained for 30 days only.

SGS India Pvt. Ltd. Consumer and Retail, Plot no. 21, Sector 3, IIT Manesar, Gurgaon District, Haryana-122050 (India) t: (+91) 124 678 7600 Regd. & Corp. Off: 5/5 House, 4B, A.S. Marg, Vikhroli (West), Mumbai-400083. t: (022) 6640 8888 f: (022) 6640 8829 www.sgs.com Member of the SGS Group (SGS SA)



TEST REPORT

Report No. : MAN:EE:8550001177 DATE : 13/09/2017

8550001177

Test result:

Test Item(s):	Unit	Results	MDL	Limit
		Sample -1		
Cadmium(Cd)	mg/kg	n.d.	5	100
Lead (Pb)	mg/kg	n.d.	5	1000
Mercury (Hg)	mg/kg	n.d.	5	1000
Hexavalent Chromium (Cr(VI))	mg/kg	n.d.	8	1000
Sum of PBBs	mg/kg	n.d.	-	1000
Monobromobiphenyl	mg/kg	n.d.	50	-
Dibromobiphenyl	mg/kg	n.d.	50	-
Tribromobiphenyl	mg/kg	n.d.	50	-
Tetrabromobiphenyl	mg/kg	n.d.	50	-
Hexabromobiphenyl	mg/kg	n.d.	50	-
Pentabromobiphenyl	mg/kg	n.d.	50	-
Heptabromobiphenyl	mg/kg	n.d.	50	-
Octabromobiphenyl	mg/kg	n.d.	50	-
Nonabromobiphenyl	mg/kg	n.d.	50	-
Decabromobiphenyl	mg/kg	n.d.	50	-
Sum of PBDEs	mg/kg	n.d.	-	1000
Monobromodiphenyl ether	mg/kg	n.d.	50	-
Dibromodiphenyl ether	mg/kg	n.d.	50	-
Tribromodiphenyl ether	mg/kg	n.d.	50	-
Tetrabromodiphenyl ether	mg/kg	n.d.	50	-
Pentabromodiphenyl ether	mg/kg	n.d.	50	-
Hexabromodiphenyl ether	mg/kg	n.d.	50	-
Heptabromodiphenyl ether	mg/kg	n.d.	50	-
Octabromodiphenyl ether	mg/kg	n.d.	50	-
Nonabromodiphenyl ether	mg/kg	n.d.	50	-
Decabromodiphenyl ether	mg/kg	n.d.	50	-

Notes:

- The maximum permissible limit is quoted from RoHS Directive (EU) 2015/863. IEC 62321 series is equivalent to EN 62321 series
http://www.cenelec.eu/dyn/www?pp=104.30:1742232870351101:::FSP_ORG_ID.FSP_LANG_ID:12586637_25
- Test has been performed as per client's request.
- The result of Hexavalent Chromium (Cr(VI)) is "ND" as the result of Chromium (Cr) is "ND", and confirmation test of Hexavalent Chromium (Cr(VI)) is not required.
- If the Chromium (Cr) content is greater than the MDL of Hexavalent Chromium (Cr(VI)), confirmation test of Hexavalent Chromium (Cr(VI)) is required.

JOE No. : 1755800428 Page 3 of 7 Client No. 855001231

This document is issued by the Company subject to its General Conditions of Service printed overleaf, available on request or accessible at <http://www.sgs.com/terms> and, for electronic format documents, subject to Terms and Conditions for Electronic Documents at www.sgs.com/terms_e-document.htm. Attention is drawn to the limitation of liability, indemnification and jurisdiction issues defined therein. Any holder of this document is advised that information contained hereon reflects the Company's findings at the time of its intervention only and within the limits of Client's instructions, if any. The Company's sole responsibility is to its Client and this document does not exonerate parties to a transaction from exercising all their rights and obligations under the transaction documents. This document cannot be reproduced except in full, without prior written approval of the Company. Any unauthorized alteration, forgery or falsification of the content or appearance of this document is unlawful and offenders may be prosecuted to the fullest extent of the law. Unless otherwise stated the results shown in this test report refer only to the sample(s) tested and such sample(s) are retained for 30 days only.

SGS India Pvt. Ltd. Consumer and Retail, Plot no. 21, Sector 3, IIT Manesar, Gurgaon District, Haryana-122050 (India) t: (+91) 124 678 7600 Regd. & Corp. Off: 5/5 House, 4B, A.S. Marg, Vikhroli (West), Mumbai-400083. t: (022) 6640 8888 f: (022) 6640 8829 www.sgs.com Member of the SGS Group (SGS SA)



Format No: SALL/TRF/GEN
Issue No: 01, Issue Date: 01-04-2017
Page 1 of 2

TEST REPORT

Test Report Issued To:

PECOX INTERNATIONAL
E-66,2ND FLOOR,SECTOR-9, NOIDA, UTTAR PRADESH,
INDIA, 201301.

Test Report No: D180215047/D180215047-2

Date of Issue: 23-Feb-2018

Sample Receipt Date: 15-Feb-2018
Date of Start of Testing: 23-Feb-2018
Date of Completion of Test: 23-Feb-2018

Customer Relationship Number 50206

Sample Description :
NYLON/PBT CONICAL INSULATOR M10X50MM(H)



Sample as Received

Customer Reference No

WO/PO No:

Kind Attention : MR ABHISHEK MAITRA
E-Mail: sales@pecox.co.in

Contact No: NA

Sample Condition :

Sample Quantity (Approx) : Sample Size (Approx) :

SAMPLE NOT DRAWN BY OUR LABORATORY. THE RESULTS RELATE ONLY TO THE ITEMS TESTED

Report issued By

Authenticity of report can be verified by mail at veri_cation@spectrolab.in

This is a Digitally Signed Report and hence doesn't require Physical Signature.

Spectro Analytical Labs Limited, E-41, Okhla Indl. Area, Phase-II, New Delhi-110020(India)

Phone :+91-11-40522000, 41611000 || Web: www.spectro.in || Email: care@spectro.in

BIS, DGS&D, DDA, MOEF and DGCA Approved, ISO 9001:2008, ISO 14001:2004 & OHSAS 18001:2007 Certfied Laboratory
Please refer to our Website www.spectro.in for Terms & Condition



TEST REPORT

Format No: SALL/TRF/GEN
Issue No: 01, Issue Date: 01-04-17

Page 2 of 2
Report No. D180215047/D180215047-2

ID - D180215047-2

Mechanical Testing

S. No.	Test Parameter	Observed Result	Test Method
1	Pull Out Load (KN)	5.60	Tested on calibrated 50 ton U.T.M.

Remark :- *Nut came out at the above load.



After Testing

-- End of Test Report --

Analyst Signature



Authorised Signatory



Format No: SALL/TRF/GEN
Issue No:01, Issue Date: 01-04-2017
Page 1 of 2

TEST REPORT

Test Report Issued To:
PECOX INTERNATIONAL
E-66,2ND FLOOR,SECTOR-9, NOIDA, UTTAR PRADESH,
INDIA, 201301,

Test Report No: D180215047/D180215047-1
Date of Issue: 24-Feb-2018
Sample Receipt Date: 15-Feb-2018
Date of Start of Testing: 24-Feb-2018
Date of Completion of Test: 24-Feb-2018

Customer Relationship Number: 50206

Sample Description:
PECOX MAKE, MS LITTING HOOK (75MM HEIGHT)



Sample as Received

Customer Reference No:
WO/PO No:

Kind Attention : MR ABHISHEK MAITRA
E-Mail: sales@pecox.co.in Contact No: NA

Sample Condition:
Sample Quantity (Approx): Sample Size (Approx):
SAMPLE NOT DRAWN BY OUR LABORATORY. THE RESULTS RELATE ONLY TO THE ITEMS TESTED

Report Issued By

Authenticity of report can be verified by mail at verification@spectrolab.in
This is a Digitally Signed Report and hence doesn't require Physical Signature.

Spectro Analytical Labs Limited, E-41, Okhla Ind. Area, Phase-II, New Delhi-110020(India)
Phone: +91-11-40522000, 41611000 | Web: www.spectro.in | Email: care@spectro.in
BIS, DGS&D, DDA, MOEF and DGCA Approved, ISO 9001:2008, ISO 14001:2004 & OHSAS 18001:2007 Certified Laboratory
Please refer to our Website www.spectro.in for Terms & Condition



TEST REPORT

Format No: SALL/TRF/
Issue No: 01, Issue Date: 01.04.17
Page 2 of 2
Report No. D180215047/D180215047-1

ID – D180215047-1

Mechanical Testing

S. No.	Test Parameter	Observed Result	Test Method
1	Breaking Load (F)	20.8f	Tested on calibrated U.T.M.



After Testing

Spectro Analytical Labs Limited, E-41, Okhla Ind. Area, Phase-II, New Delhi-110020(India)
Phone: +91-11-40522000, 41611000 | Web: www.spectro.in | Email: care@spectro.in
BIS, DGS&D, DDA, MOEF and DGCA Approved, ISO 9001:2008, ISO 14001:2004 & OHSAS 18001:2007 Certified Laboratory
Please refer to our Website www.spectro.in for Terms & Condition

CENTRAL POWER RESEARCH INSTITUTE



TEST REPORT

CPRI

Test Report Number & Date	CPRI/TL/IN/2017/101	Date: 08.09.2017
Name and address of the Customer	M/s. A. Care International E-66, 2nd Floor, Sector-9, Noida	
Name & Address of the Manufacturer	M/s. A. Care International E-66, 2nd Floor, Sector-9, Noida	
Particulars of the apparatus tested	1) Wire, Control Insulator: 662D (model: MITG20C)	
Condition of samples as receipt	New	
Type	Control Nylon 66/PPS/glass fibre	
Designation	High Voltage Polymeric Insulator: HVT-100000	
Serial Number	HVT100	
No. of samples tested	One	
Address of facility	CPRI	
CPRI Sample Code Number	CPRI/TL/IN/2017/101	
Particulars of test conducted	High Voltage Frequency Voltage Withstand Test	
Test in accordance with standard/specification	As per Customer requirements	
Sampling Plan	Not Applicable	
Customer's requirement	Test in accordance with following requirements:	
Deviation if any	No	
Name of the witnessing person	Mr. Prince Kumar, Business Manager	
a) Customer's representative	NI	
b) Other than Customer's representative	NI	
Test Subcontracted with address of the	None	
Statement constituting this report its scope		
Number of sheets	Three	
Number of Original copies	NI	
Number of copies	NI	
Number of photos	One	
Number of Circuit Diagrams	NI	
Number of Drawings	One Drawing, No. (C211-1830)	

P. K. Mishra
Test Engineer

(S. Bhattacharya)
Unit Head

CPRI
Central Power Research Institute
Regional Testing Laboratory, No. 2A, Institutional Area, Sector - 62, Noida - 201309
Phone no: (0120) 2402022, Fax: (0120) 2402024

Sheet 1 of 1

HIGH VOLTAGE LABORATORY
CENTRAL POWER RESEARCH INSTITUTE
Regional Testing Laboratory, No. 2A, Institutional Area, Sector - 62, Noida - 201309
Phone no: (0120) 2402022, Fax: (0120) 2402024

CENTRAL POWER RESEARCH INSTITUTE



TEST REPORT

CPRI

Test Report No.	CPRI/TL/IN/2017/101	Date:	08.09.2017
Laboratory condition			
Dry bulb temperature: 27°C, Wet bulb temperature: 25°C, Atmospheric pressure: 1014 mb			
Dry Power Frequency Voltage Withstand Test at 10 kV/Sec			
Type Connection	Voltage applied (kV/Sec)	Remarks	
The sample was connected as per circuit diagram and top-end of insulator was connected to high voltage	10	Withstand for 60 sec.	
Conclusion: The sample tested complies as per customer requirements.			

Sanjay Kumar
Unit Head

Sheet 2 of 1

HIGH VOLTAGE LABORATORY
CENTRAL POWER RESEARCH INSTITUTE
Regional Testing Laboratory, No. 2A, Institutional Area, Sector - 62, Noida - 201309
Phone no: (0120) 2402022, Fax: (0120) 2402024



Format No: SALLGN/TRF/GEN
Issue No:01, Issue Date: 01-04-2017
Page 1 of 2

TEST REPORT

Test Report Issued To:

PECOX INTERNATIONAL

E-66,2ND FLOOR,SECTOR-9, NOIDA, UTTAR PRADESH,
INDIA, 201301,

Test Report No: N180530010/N180530010-1

Date of Issue: 19-Jun-2018



Sample Booking/Receipt Date: 30-May-2018

Date of Start of Testing: 16-Jun-2018

Date of Completion of Test: 19-Jun-2018

Customer Relationship Number 50206

Sample Description :

PECOX FERRULING / PRINTING SLEEVE 2.5 / 3.2 / 3.5 / 4.2



Customer Reference No :

WO/PO No:

Kind Attention :

E-Mail: pecoxinternational@gmail.com

Contact No: NA

Sample Condition :

Sample Quantity (Approx) : Sample Size (Approx) :

SAMPLE NOT DRAWN BY OUR LABORATORY. THE RESULTS RELATE ONLY TO THE ITEMS TESTED

Report Issued by

Authenticity of report can be verified by mail at verification@spectrolab.in
This is a Digitally Signed Report and hence doesn't require Physical Signature.

Spectro Analytical Labs Limited S-1, GNEPIP, Surajpur Industrial Area,Phase-V, Kaana, Greater Noida-201308 (India)

Phone : +91-120-2341250,2341251 || URL : www.spectro.in || Email : care@spectro.in

BIS & DDA Approved, ISO 9001:2008, ISO 14001:2004 & OHSAS 18001:2007 Certified Laboratory
Please refer to our Website www.spectro.in for Terms & Condition



TEST REPORT

Format No: SALLGN/TRF/GEN
Issue No: 01, Issue Date: 01.04.17

Page 2 of 2

Report No. N180530010/N180530010-1

Date of start of test : 16/06/2018
Date of completion of test : 19/06/2018

ID-N180530010-1

S. No. Name of test Results Test Method

1. Flammability test Guideline of
Horizontal Burning test ASTM D635
Condition of test piece
(At 23° C and 50% R.H. for 48 hour)
Burning Rate, mm/min Cease to burn
before 25mm
mark after removal
the test flame

Remark: The testing was done on component
(Required 130x13x3mm size of ten sample as per specification)



TEST REPORT

Report No. : BG-EE:9510002416 DATE : 15/06/2018

PECOX INTERNATIONAL
F-76,6R FLOOR
SECTOR- 08, NOIDA
NOIDA UTTAR PRADESH (09) 201301
INDIA

CONTACT PERSON SHANKAR SHARMA

THE FOLLOWING SAMPLE(S) WAS/WERE SUBMITTED AND IDENTIFIED BY/ON BEHALF OF THE CUSTOMER AS :

SAMPLE DESCRIPTION PECOX LT HEAT SHRINKABLE BUS BAR SLEEVES

COLOUR BLUE

MATERIAL PVC

REF NO. PHS170

COUNTRY OF ORIGIN INDIA

SAMPLE RECD ON. 06/06/2018

TEST(S) REQUESTED ROHS 6E

TESTING PERIOD : 9/06/2018 - 14/06/2018

CONCLUSION : Based on the performed tests on submitted sample(s), the results of Cadmium, Lead, Mercury, Hexavalent chromium, Polybrominated biphenyls (PBBs), Polybrominated diphenyl ethers (PBDEs) comply with the limits as set by RoHS Directive (EU) 2015/863 amending Annex II to Directive 2011/65/EU

Per Pro SGS India Pvt Ltd.

Authorized Signatory
S.Sasikumar
(Assistant Manager)- RSTS
Email your Test Report Related Enquiries at Feedback.HI.T@sgs.com

JOE No. : 1851800679

4213652

Page 1 of 7

Control No.:9515022191

This document is issued by the Company subject to its General Conditions of Service printed overleaf, available on request or accessible at <http://www.sgs.com/terms> and, for electronic format documents, subject to Terms and Conditions for Electronic Documents at www.sgs.com/terms_electronicformat.htm. Attention is drawn to the limitation of liability, indemnification and jurisdiction issues defined therein. Any holder of this document is advised that information contained hereon reflects the Company's findings at the time of its intervention only and within the limits of Client's instructions, if any. The Company's sole responsibility is to its Client and this document does not exonerate parties to a transaction from exercising all their rights and obligations under the transaction documents. This document cannot be reproduced except in full, without prior written approval of the Company. Any unauthorized alteration, forgery or falsification of the content or appearance of this document is unlawful and offenders may be prosecuted to the fullest extent of the law. Unless otherwise stated the results shown in this test report refer only to the sample(s) tested and such sample(s) are retained for 30 days only.

SGS India Pvt. Ltd. Consumer and Retail, Ahmed Plaza, no. 381/2, New Bypass NO. 88/45/45, Bandra East, Mumbai-400052, India (022) 6640 8800 F: (022) 6640 8829 www.sgs.com
Member of the SGS Group (SGS SA)



TEST REPORT

Report No. : BG-EE:9510002416 DATE : 15/06/2018

Test result:

Test Item(s):	Unit	Results	MDL	Limit
		Sample -1		
Cadmium(Cd)	mg/kg	n.d.	5	100
Lead (Pb)	mg/kg	n.d.	5	1000
Mercury (Hg)	mg/kg	n.d.	5	1000
Hexavalent Chromium (Cr(VI))*	mg/kg	n.d.	8	1000
Sum of PBBs	mg/kg	n.d.	-	1000
Monobromodiphenyl	mg/kg	n.d.	50	-
Dibromodiphenyl	mg/kg	n.d.	50	-
Tribromodiphenyl	mg/kg	n.d.	50	-
Tetrabromodiphenyl	mg/kg	n.d.	50	-
Hexabromodiphenyl	mg/kg	n.d.	50	-
Pentabromodiphenyl	mg/kg	n.d.	50	-
Heptabromodiphenyl	mg/kg	n.d.	50	-
Octabromodiphenyl	mg/kg	n.d.	50	-
Nonabromodiphenyl	mg/kg	n.d.	50	-
Decabromodiphenyl	mg/kg	n.d.	50	-
Sum of PBDEs	mg/kg	n.d.	-	1000
Monobromodiphenyl ether	mg/kg	n.d.	50	-
Dibromodiphenyl ether	mg/kg	n.d.	50	-
Tribromodiphenyl ether	mg/kg	n.d.	50	-
Tetrabromodiphenyl ether	mg/kg	n.d.	50	-
Pentabromodiphenyl ether	mg/kg	n.d.	50	-
Hexabromodiphenyl ether	mg/kg	n.d.	50	-
Heptabromodiphenyl ether	mg/kg	n.d.	50	-
Octabromodiphenyl ether	mg/kg	n.d.	50	-
Nonabromodiphenyl ether	mg/kg	n.d.	50	-
Decabromodiphenyl ether	mg/kg	n.d.	50	-

Notes:

- The maximum permissible limit is quoted from RoHS Directive (EU) 2015/863. IEC 62321 series is equivalent to EN 62321 series
http://www.cenelc.eu/dyn/www?ps=104301742232870351101...:FSP_ORG_ID:FSP_LANG_ID:1258637_25
- Test has been performed as per client's request.
- The result of Hexavalent Chromium (Cr(VI)) is "ND" as the result of Chromium (Cr) is "ND", and confirmation test of Hexavalent Chromium (Cr(VI)) is not required.
- If the Chromium (Cr) content is greater than the MDL of Hexavalent Chromium (Cr(VI)), confirmation test of Hexavalent Chromium (Cr(VI)) is required.

JOE No. : 1851800679

4213652

Page 3 of 7

Control No.:9515022191

This document is issued by the Company subject to its General Conditions of Service printed overleaf, available on request or accessible at <http://www.sgs.com/terms> and, for electronic format documents, subject to Terms and Conditions for Electronic Documents at www.sgs.com/terms_electronicformat.htm. Attention is drawn to the limitation of liability, indemnification and jurisdiction issues defined therein. Any holder of this document is advised that information contained hereon reflects the Company's findings at the time of its intervention only and within the limits of Client's instructions, if any. The Company's sole responsibility is to its Client and this document does not exonerate parties to a transaction from exercising all their rights and obligations under the transaction documents. This document cannot be reproduced except in full, without prior written approval of the Company. Any unauthorized alteration, forgery or falsification of the content or appearance of this document is unlawful and offenders may be prosecuted to the fullest extent of the law. Unless otherwise stated the results shown in this test report refer only to the sample(s) tested and such sample(s) are retained for 30 days only.

SGS India Pvt. Ltd. Consumer and Retail, Ahmed Plaza, no. 381/2, New Bypass NO. 88/45/45, Bandra East, Mumbai-400052, India (022) 6640 8800 F: (022) 6640 8829 www.sgs.com
Member of the SGS Group (SGS SA)

CENTRAL POWER RESEARCH INSTITUTE
TEST REPORT
CPRI

Test Report No. CPRI/DAHV/18TS202 Date: 18.10.2018

Name & Address of the Customer: M/s PeCoX International
E-66, 2nd Floor, Sector-9, Noida (UP)
Name and Address of the Manufacturer: M/s PeCoX International
E-66, 2nd Floor, Sector-9, Noida (UP)
Particulars of sample tested: 5 KV Insulator
Condition of Sample on receipt: Good

Type: NI
Designation: PBI404P
Serial Number: NI
Number of samples tested: One
(Date) of Test(s): 11.10.2018
CPRI Sample code Note: NCVN/18S2108
Particulars of tests conducted: Dry Power Frequency Voltage withstand Test
Test in accordance with: IS: 9431, IS: 9 and as per Customer requirement
Sampling Plan: NI
Customer's Requirement: Dry Power Frequency Voltage withstand Test at 5 MVrms
Deviation if any: NI
Name of the witnessing persons: NI
Customer's representative: NI
Other than customer's representatives: NI
Test subcontracted with address of the laboratory: None
Documents constituting this report (in words):
Number of Sheets: Three
Number of Drawings: Nil
Number of Graphs: Nil
Number of Photos: One
Number of Test circuit Diagrams: Nil
Number of Drawings: One (Dry No. - PINSULATOR08)

(M.K.Jaiswal) Test Engineer (S.Bhattacharyya) Head of Division Approved by

CENTRAL POWER RESEARCH INSTITUTE
TEST REPORT
CPRI

Test Report No. CPRI/DAHV/18TS202 Date: 18.10.2018

Laboratory conditions
(Dry bulb temperature, 30.0°C, Wet bulb temperature, 28°C, Atmospheric pressure, 988 mbars)

Dry Power Frequency Voltage withstand Test at 5 MVrms with correction factor - 1.0

Test Condition	Voltage applied (kVrms)	Remarks
The insulator was mounted on its plate and connected by earthed and top end of insulator was connected to high voltage source	5.0	Withstood for 60 sec.

Conclusion: Samples tested comply with IS: 9431, IS: 9 of IS 9431, 1978

(M.K.Jaiswal) Test Engineer

SPECTRO[®]
Analytical Labs Limited
CIN:U74220DL1998PLC092698

Format No: SALLGN/TRF/GEN
Issue No:01, Issue Date: 01-04-2017
Page 1 of 2

TEST REPORT

Test Report Issued To: **PECOX INTERNATIONAL**
E-66,2ND FLOOR,SECTOR-9, NOIDA, UTTAR PRADESH, INDIA, 201301.

Test Report No: N180928006/N180928006-1
Date of Issue: 12-Oct-2018

Sample Booking/Receipt Date: 28-Sep-2018
Date of Start of Testing: 12-Oct-2018
Date of Completion of Test: 12-Oct-2018

Customer Relationship Number: 50206

Sample Description: PECOX P-SERIES INSULATOR, PBI404P

Customer Reference No:

Kind Attention: MR ABHISHEK MAITRA
E-Mail: pecoxinternational@gmail.com Contact No: NA

Sample Condition: NA
Sample Quantity (Approx): NA Sample Size (Approx): NA

SAMPLE NOT DRAWN BY OUR LABORATORY. THE RESULTS RELATE ONLY TO THE ITEMS TESTED

Report Issued by

Authenticity of report can be verified by mail at verification@spectrolab.in
This is a Digitally Signed Report and hence doesn't require Physical Signature.

Spectro Analytical Labs Limited S-1, GNEPIP, Surajpur Industrial Area, Phase-V, Kasna, Greater Noida-201308 (India)
Phone: +91-120-2341250,2341251 || URL: www.spectro.in || Email: care@spectro.in
BIS & DDA Approved, ISO 9001:2008, ISO 14001:2004 & OHSAS 18001:2007 Certified Laboratory
Please refer to our Website www.spectro.in for Terms & Condition

SPECTRO[®]
Analytical Labs Limited
CIN:U74220DL1998PLC092698

Format No: S4BMTRF/GEN
Issue No: 06 Issue Date: 04/07
Page 2 of 2
Test Report No. N180928006/N180928006-1

TEST REPORT

ID-N18@28006

Mechanical Testing

S.No.	Test Parameter	Observed Result	Test Method
1	Pull out Load (KN),Kgf	(7.30),744.9	Tested by Calibrated Tm UTM
2	Applied Torque (Nm)	140	Tested by Calibrated Torque Wrench

(1) Pull out Test

Sample before test Sample during Test Sample after Test

(2) Torque Test

Sample during Torque Test

-- End of Test Report --

Analyst Signature: (Signature) Authorised Signatory: (Signature)

Spectro Analytical Labs Limited S-1, GNEPIP, Surajpur Industrial Area, Phase-V, Kasna, Greater Noida-201308 (India)
Phone: +91-120-2341250,2341251 || URL: www.spectro.in || Email: care@spectro.in
BIS, DDA Approved, ISO 9001:2008, ISO 14001:2004 & OHSAS 18001:2007 Certified Laboratory
Please refer to our Website www.spectro.in for Terms & Condition

Mechanical

Properties	Unit	Test Method	Thermoset	Engineering Glass Filled Thermoplastic
Tensile Strength at Yield	Mpa	ASTM D - 638	45-70	125-130
Tensile Elongation at yield	%	ASTM D - 638	1.5	7
Flexural Strength	Mpa	ASTM D - 790	85-90	135-140
Flexural Modulus	Gpa	ASTM D - 790	9	3.3
Notch Impact Strength at 23°C	KJ/m	ASTM D - 256	0.3	6

Physical

Properties	Unit	Test Method	Thermoset	Engineering Glass Filled Thermoplastic
Specific Gravity	g/cm ³	ASTMD-792	1.75-1.90	1.36
Glass Fibre Content	%		15-20	33

Electricals

Properties	Unit	Test Method	Thermoset	Engineering Glass Filled Thermoplastic
Dialectic Strength	(KV/mm)	ASTM D-149	10-12	16-18
Comparative Tracking Index	(Volts)	ASTM D-3638	Material Group-I (>= 600)	Material Group-I (>= 600)
ARC Resistance	(Secs.)	ASTM D- 495	170-180	200
Glow Wire Ignition Test Over 3mm Thickness Specimen	(°C)	IEC-60695-2-12	950	750-960
Hot Wire Ignition Test	(Secs.)	ASTM D-3874	>120	7-15
RTI, Str (Thickness 3mm)	(°C)	UL-746B	130	130
RTI, Elect. (Thickness 3mm)	(°C)	UL-746B	105	130
High Voltage Arc Tracking Rate	(mm/min)	UL-746A	0 through 10	over 10 through 25.4
High Amp Arc Ignition	mean no. or arcs	UL-746A	>120	>120
Relative Permittivity (1Mhz)		IEC 60250	4.5	3.8
Dissipation Factor (1 Mhz)	E4	IEC 60250	-	150

"ENGINEERED FOR ELECTRICAL CONTROL PANELS"

PeCOX[®]
Quality Never Dies

PeCox International



F-76, Ground Floor, Sector-08, Noida,
Uttar Pradesh - 201301
+91- 8368782887, +91-8178320583,
0120-4098193

sales@pecox.co.in | www.pecox.co.in



Authorized Channel Partner