

# Motor starters up to 150 A

## TeSys GV2, GV3 and GV7 motor circuit-breakers

---

■ **Thermal-magnetic circuit-breakers**

**Selection guide** ..... **page 30**

- Presentation ..... *page 34*
- Characteristics ..... *page 36*
- Curves ..... *page 52*
- References ..... *page 74*
- Dimensions, mounting ..... *page 94*
- Schemes ..... *page 102*

■ **Magnetic circuit-breakers**

**Selection guide** ..... **page 32**

- Characteristics ..... *page 42*
- Curves ..... *page 52*
- References ..... *page 80*
- Dimensions, mounting ..... *page 104*
- Schemes ..... *page 109*

■ **Enclosed circuit-breakers**

- References, dimensions, schemes ..... *page 110*

**Applications**

**Protection of motors against short-circuits and overloads**



<b>Tripping threshold on short-circuit</b>	13 I <sub>n</sub>			
<b>Standard motor power ratings in AC-3, 415 V</b>	Up to 15 kW	Up to 30 kW	37 kW	
<b>Operational current at 415 V</b>	0.1...32 A	9...65 A	56...80 A	
<b>Breaking capacity at 415 V (I<sub>cu</sub>) to IEC 60947-2</b>	10...100 kA	35...100 kA	50...100 kA	15 kA
<b>Door interlock mechanism</b>	Without	With	With	Without
<b>Circuit-breaker type</b>	<b>GV2 ME</b>	<b>GV2 P</b>	<b>GV3 P</b>	<b>GV3 ME80</b>
<b>Pages</b>	74 and 75	76	76	76

Protection of motors with high current peak on starting



7.5...110 kW

12...220 A

35 and 36 kA

With

**GV7 RE**

77

70 kA

**GV7 RS**

20 In

Up to 11 kW

0.25...23 A

15...100 kA

With

**GV2 RT**

78 and 79

**Applications**

**Protection of motors**

Magnetic circuit-breakers provide short-circuit protection. They must be combined with thermal overload relays to provide motor overload protection.



Tripping threshold on short-circuit

13 I<sub>n</sub>

Standard motor power ratings in AC-3, 415 V

Up to 15 kW

Operational current at 415 V

0.4...32 A

Breaking capacity at 415 V (I<sub>cu</sub>) to IEC 60947-2

10...100 kA

35...100 kA

Door interlock mechanism

With

Circuit-breaker type

**GV2 LE**

**GV2 L**

Pages

80

81

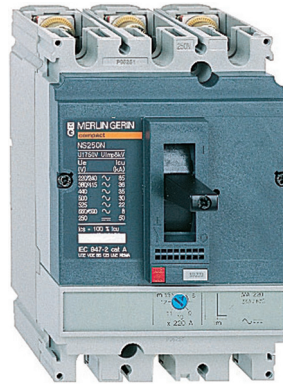

		6...14 In	8...13 In	6.3...12.5 In
Up to 30 kW	37 kW	0.37...250 kW		
25...65 A	80 A	1.5...500 A		
50...100 kA	35 kA	25.7 and 150 kA	35.7...150 kA	45.7...150 kA
With	With	With		
<b>GV3 L</b>	<b>GK3 EF80</b>	<b>NS 80</b>	<b>NS 100 to NS 250</b>	<b>NS 400 and NS 630</b>
81	81	Please consult the Merlin Gerin catalogue - Low Voltage Distribution		

# TeSys protection components

## Thermal-magnetic motor circuit-breakers

### GV2, GV3 and GV7

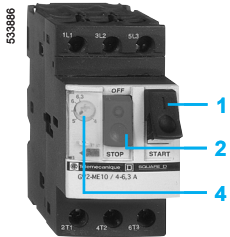

GV2 ME with screw clamp terminals

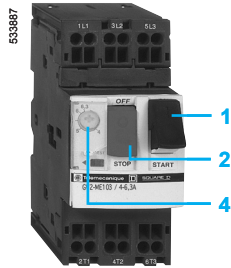

GV2 ME with spring terminals connections

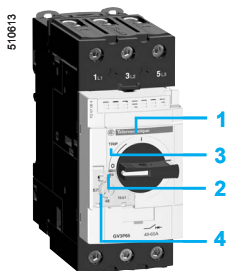

GV3 P

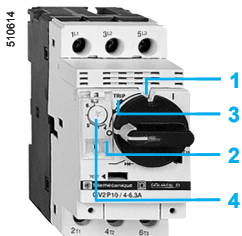

GV2 P

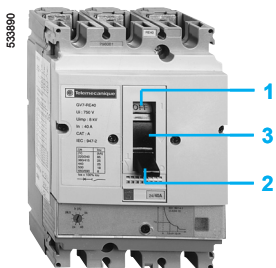

GV7 R

### Presentation

GV2 ME, GV2 P, GV3 ME, GV3 P and GV7 R motor circuit-breakers are 3-pole thermal-magnetic circuit-breakers **specifically designed for the control and protection of motors**, conforming to standards IEC 60947-2 and IEC 60947-4-1.

### Connection

#### GV2

GV2 ME and GV2 P circuit-breakers are designed for connection by screw clamp terminals.

Circuit-breaker GV2 ME can be supplied with lugs or spring terminal connections. Spring terminal connections ensure secure, permanent and durable clamping that is resistant to harsh environments, vibration and impact and are even more effective when conductors without cable ends are used. Each connection can take two independent conductors.

#### GV3

GV3 circuit-breakers feature connection by BTR screws (hexagon socket head), tightened using a n° 4 Allen key.

This type of connection uses the **EverLink®** system with creep compensation (1) (Schneider Electric patent).

This technique makes it possible to achieve accurate and durable tightening torque, in order to avoid cable creep.

GV3 circuit-breakers are also available with connection by lugs. This type of connection meets the requirements of certain Asian markets and is suitable for applications subject to strong vibration, such as railway transport.

#### GV7

GV7 circuit-breakers: with connection by screw clamp terminals (for bars and lugs) and by clip-on connectors.

### Operation

Control is manual and local when the motor circuit-breaker is used on its own. Control is automatic and remote when it is associated with a contactor.

#### GV2 ME and GV3 ME80

Pushbutton control.

Energisation is controlled manually by operating the Start button "I" **1**. De-energisation is controlled manually by operating the Stop button "O" **2**, or automatically by the thermal-magnetic protection elements or by a voltage trip attachment.

#### GV2 P, GV3 P and GV7 R

- Control by rotary knob: for GV2 P and GV3 P
- Control by rocker lever: for GV7 R.

Energisation is controlled manually by moving the knob or rocker lever to position "I" **1**. De-energisation is controlled manually by moving the knob or rocker lever to position "O" **2**. De-energisation due to a fault automatically places the knob or rocker lever in the "Trip" position **3**.

Re-energisation is possible only after having returned the knob or rocker lever to position "O".

(1) Creep: normal crushing phenomenon of copper conductors, that is accentuated over time.

### Presentation (continued)

#### Protection of motors and personnel

Motor protection is provided by the thermal-magnetic protection elements incorporated in the motor circuit-breaker.

The **magnetic** elements (short-circuit protection) have a non-adjustable tripping threshold, which is equal to 13 times the maximum setting current of the thermal trips.

The **thermal** elements (overload protection) include automatic compensation for ambient temperature variations.

The rated operational current of the motor is displayed by means of a graduated knob 4. Personnel protection is also provided. All live parts are protected against direct finger contact from the front panel.

The addition of an undervoltage trip allows the circuit-breaker to be de-energised in the event of an undervoltage condition. The user is therefore protected against sudden starting of the machine when normal voltage is restored, since the Start button "I" has to be pressed to restart the motor.

With the addition of a shunt trip, de-energisation of the unit can be remotely controlled.

The operators on both open-mounted and enclosed motor circuit-breakers can be locked in the Stop position "O" by up to 4 padlocks.

Because they are suitable for isolation, these circuit-breakers, in the open position, provide an adequate isolation distance and indicate the actual position of the moving contacts by the position of the operators.

#### Special features

These motor circuit-breakers are easily installed in any configuration thanks to their universal fixing arrangement: screw fixing or clip-on mounting on symmetrical, asymmetrical or combination rails.

Environment			GV2 ME		GV2 P	GV3 P	GV3 ME80	GV7 R			
<b>Circuit-breaker type</b>			GV2 ME		GV2 P	GV3 P	GV3 ME80	GV7 R			
<b>Conforming to standards</b>			IEC 60947-1, 60947-2, 60947-4-1, EN 60204, UL 508, CSA C 22.2 n° 14-05, NF C 63-650, 63-120, 79-130, VDE 0113, 0660			IEC/EN 60947-1, 60947-2, 60947-4-1, UL 508 type E, CSA C 22.2 n° 14-05 type E	IEC/EN, NF EN, BS EN, DINEN60947-2, 60947-4-1	IEC 60947-1, 60947-2, 60947-4-1, EN 60947-1, 60947-2, EN 60947-4-1, NF C 63-650, NF C 63-120, 79-130, VDE 0113, 0660			
<b>Product certifications</b>			UL, CSA, CCC, CEBC, GOST, TSE, BV, GL, LROS, DNV, PTB, EZU, SETI, RINA, ATEX		UL (1), CSA, PTB, EZU, GOST, TSE, DNV, LROS, GL, BV, RINA, CCC, ATEX	UL, CSA, CCC (pending), GOST, ATEX	UL, CSA, LROS	UL, DNV, CCC			
<b>Protective treatment</b>			"TH"			"TH"	"TC"	"TC"			
<b>Degree of protection</b>	Conforming to IEC 60529	Open mounted	IP 20			IP 20	IP 20	IP 405 with terminal shrouds			
		In enclosure	<b>GV2 M●01:</b> IP 41 <b>GV2 M●02:</b> IP 55	–		<b>GV3 PC01 and GV3 PC02:</b> IP 55	<b>GV3 CE01:</b> IP 55	–			
<b>Shock resistance</b>	Conforming to IEC 60068-2-27		30 gn -11 ms			On: 15 gn -11 ms Off: 30 gn -11 ms	22 gn - 20 ms	15 gn -11 ms			
<b>Vibration resistance</b>	Conforming to IEC 60068-2-6		5 gn (5...150 Hz)			4 gn (5...300 Hz)	2.5 gn (0...25 Hz)	2.5 gn (25 Hz)			
<b>Ambient air temperature</b>	Storage	°C	-40...+80	-40...+80		-40...+80	-40...+80	-55...+95			
	Operation	Open mounted	°C	-20...+60	-20...+60		-20...+60 (2)	-20...+60	-25...+70		
<b>Temperature compensation</b>		In enclosure	°C	-20...+40	-20...+40		-20...+40	–			
		Open mounted	°C	-20...+60	-20...+60		-20...+60	-25...+55 (3)			
	In enclosure	°C	-20...+40	-20...+40		-20...+40	-20...+40	–			
<b>Flame resistance</b>	Conforming to IEC 60695-2-1	°C	960			960	960	960			
<b>Maximum operating altitude</b>		m	2000			3000	3000	2000			
<b>Suitable for isolation</b>	Conforming to IEC 60947-1 § 7-1-6		Yes			Yes	–	Yes			
<b>Resistance to mechanical impact</b>		J	0.5	0.5		0.5	0.5	0.5			
			IK 06			IK 09 (in enclosure)	–	–			
<b>Sensitivity to phase failure</b>			Yes, conforming to IEC 60947-4-1 § 7-2-1-5-2								
Technical characteristics											
Circuit-breaker type			GV2 ME	GV2 P	GV2 RT	GV3 P	GV3 ME80	GV7 R●20... R●100	GV7 R●150	GV7 R●220	
<b>Utilisation category</b>	Conforming to IEC 60947-2		A			A	A	A			
	Conforming to IEC 60947-4-1		AC-3			AC-3	AC-3	AC-3			
<b>Rated operational voltage (U<sub>e</sub>)</b>	Conforming to IEC 60947-2		V	690		690	690	690			
<b>Rated insulation voltage (U<sub>i</sub>)</b>	Conforming to IEC 60947-2		V	690		690	690	750			
<b>Rated voltage</b>	Conforming to CSA C22-2 n° 14, UL 508		V	600		600	600 (B600)	600			
<b>Rated operational frequency</b>	Conforming to IEC 60947-4-1 UL, CSA		Hz	50/60		50/60	50/60	50/60			
<b>Rated impulse withstand voltage (U<sub>imp</sub>)</b>	Conforming to IEC 60947-2		kV	6		6	6	8			
<b>Total power dissipated per pole</b>			W	2.5		8	8	5	8.7	14.5	
<b>Mechanical durability (C.O.: Close, Open)</b>			C.O.	100 000		50 000	30 000	50 000	40 000	20 000	
<b>Electrical durability for AC-3 duty</b>	440 V In/2		C.O.	100 000		–	30 000	50 000	40 000	20 000	
	440 V In		C.O.	–		50 000	–	30 000	20 000	10 000	
<b>Duty class (maximum operating rate)</b>			C.O./h	25		25	25	25			
<b>Maximum conventional rated thermal current (I<sub>th</sub>)</b>	Conforming to IEC 60947-4-1		A	0.16... 32	0.16... 32	0.40... 23	13... 65	80	12... 100	150	220
<b>Rated duty</b>	Conforming to IEC 60947-4-1		Continuous duty								

(1) UL 508 type E for **GV2 P●●H7**

(2) Leave a space of 9 mm between 2 circuit-breakers: either an empty space, or side mounting add-on contact blocks. Side by side mounting is possible up to 40 °C.

(3) For operation up to 70 °C, please consult your Regional Sales Office.



### Mounting characteristics

**Operating position**  
Without derating, in relation to normal vertical mounting plane (1)

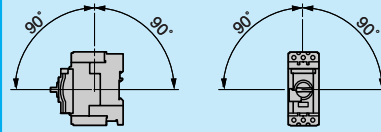

### Connection characteristics

#### Connection to screw clamp terminals or spring terminals

Bare cables

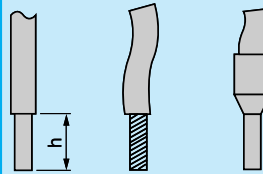

Circuit-breaker type			GV2 ME		GV2 P		GV3 P		GV3 ME80	
Connection to screw clamp terminals (2) (Max. number of conductors x c.s.a.)		mm <sup>2</sup>	Min.	Max.	Min.	Max.	Min.	Max.	Min.	Max.
	Solid cable	mm <sup>2</sup>	2 x 1	2 x 6	2 x 1	2 x 6	2 x 1	1 x 25 and 1 x 35	1 x 2.5	1 x 35
	Flexible cable without cable end	mm <sup>2</sup>	2 x 1.5	2 x 6	2 x 1.5	2 x 6	2 x 1	1 x 25 and 1 x 35	1 x 2.5	2 x 16
	Flexible cable with cable end	mm <sup>2</sup>	2 x 1	2 x 4	2 x 1	2 x 4	2 x 1	1 x 25 and 1 x 35	1 x 2.5	2 x 16
<b>Tightening torque</b>		<b>N.m</b>	1.7	1.7	1.7	1.7	5	5: 25 mm <sup>2</sup> 8: 35 mm <sup>2</sup>	5	5
<b>Connection to spring terminals</b>										
<b>Number of conductors x c.s.a.</b>										
	Solid cable	mm <sup>2</sup>	2 x 1 (3)	2 x 6	–	–	–	–	–	–
	Flexible cable without cable end	mm <sup>2</sup>	2 x 1.5 (3)	2 x 4	–	–	–	–	–	–

#### Connection by bars or lugs

Bars or lugs

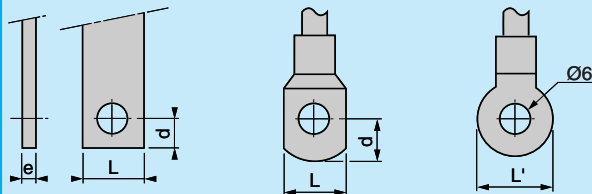

Circuit-breaker type			GV2 ME●●6	GV3 P●●6	GV7 R●20...R●100	GV7 R●150	GV7 R●220
<b>Pitch</b>	Without spreaders	mm	13.5	17.5	35	35	35
	With spreaders	mm	–	–	45	45	45
<b>Bars or cables with lugs</b>	e	mm	≤ 6	≤ 6	≤ 6	≤ 6	≤ 6
	L	mm	≤ 9.5	≤ 13.5	≤ 25	≤ 25	≤ 25
	L'	mm	≤ 9.5	≤ 16.5	–	–	–
	d	mm	≤ 10	≤ 10	≤ 10	≤ 10	≤ 10
<b>Screws</b>			M4	M6	M6	M8	M8
	Tightening torque	<b>N.m</b>	1.7	6	10	15	15
<b>Bare cables (copper or aluminium) with connectors</b>	Height (h)	mm	–	–	20	20	20
	C.s.a.	mm <sup>2</sup>	–	–	1.5...95	1.5...95	1.5...185
	Tightening torque	<b>N.m</b>	–	–	15	15	15

(1) When mounting on a vertical rail, fit a stop to prevent any slippage.  
 (2) For motor circuit-breakers **GV3 P**: BTR screws, hexagon socket head. In accordance with local electrical wiring regulations, a size 4 insulated Allen key must be used (reference **LAD ALLEN4**, see page 173).  
 (3) For cross-sections 1 to 1.5 mm<sup>2</sup>, the use of an **LA9 D99** cable end reducer is recommended.

# TeSys protection components

## Thermal-magnetic motor circuit-breakers

### GV2 ME and GV2 P

Breaking capacity of GV2 ME and GV2 P																							
Circuit-breaker type				GV2 ME								GV2 P											
				01 to 06	07	08	10	14	16	20	21 & 22	32	01 to 06	07	08	10	14	16	20	21 & 22	32		
<b>Rating</b>			<b>A</b>	0.1 to 1.6	2.5	4	6.3	10	14	16	18	23 & 25	32	0.1 to 1.6	2.5	4	6.3	10	14	16	18	23 & 25	32
<b>Breaking capacity</b> conforming to IEC 60947-2	230/240 V	lcu	<b>kA</b>	*	*	*	*	*	*	*	*	50	50	*	*	*	*	*	*	*	*	*	*
		lcs % (1)		*	*	*	*	*	*	*	*	100	100	*	*	*	*	*	*	*	*	*	*
	400/415 V	lcu	<b>kA</b>	*	*	*	*	*	15	15	15	10	*	*	*	*	*	*	*	50	50	50	
		lcs % (1)		*	*	*	*	*	50	50	40	50	*	*	*	*	*	*	50	50	50		
	440 V	lcu	<b>kA</b>	*	*	*	50	15	8	8	6	6	*	*	*	*	*	*	50	20	20	20	
		lcs % (1)		*	*	*	100	100	50	50	50	50	*	*	*	*	*	75	75	75	75		
	500 V	lcu	<b>kA</b>	*	*	*	50	10	6	6	4	4	*	*	*	*	*	50	42	10	10	10	
		lcs % (1)		*	*	*	100	100	75	75	75	75	*	*	*	*	100	75	75	75	75		
	690 V	lcu	<b>kA</b>	*	3	3	3	3	3	3	3	3	*	8	8	6	6	6	4	4	4		
		lcs % (1)		*	75	75	75	75	75	75	75	75	*	100	100	100	100	100	100	100	100		
<b>Associated fuses (if required)</b> if lsc > breaking capacity lcu conforming to IEC 60947-2	230/240 V	aM	<b>A</b>	*	*	*	*	*	*	*	*	80	80	*	*	*	*	*	*	*	*	*	
		gG	<b>A</b>	*	*	*	*	*	*	*	*	100	100	*	*	*	*	*	*	*	*	*	
	400/415 V	aM	<b>A</b>	*	*	*	*	*	63	63	80	80	*	*	*	*	*	*	100	100	100		
		gG	<b>A</b>	*	*	*	*	*	80	80	100	100	*	*	*	*	*	*	125	125	125		
	440 V	aM	<b>A</b>	*	*	*	50	50	50	50	63	63	*	*	*	*	*	50	63	80	80		
		gG	<b>A</b>	*	*	*	63	63	63	63	80	80	*	*	*	*	*	63	80	100	100		
	500 V	aM	<b>A</b>	*	*	*	50	50	50	50	50	50	*	*	*	*	*	50	50	50	50		
		gG	<b>A</b>	*	*	*	63	63	63	63	63	63	*	*	*	*	63	63	63	63	63		
	690 V	aM	<b>A</b>	*	16	25	32	32	40	40	40	40	*	20	25	40	40	50	50	50	50		
		gG	<b>A</b>	*	20	32	40	40	50	50	50	50	*	25	32	50	50	63	63	63	63		

\* > 100 kA.  
(1) As % of lcu.

Breaking capacity of GV2 ME and GV2 P (used in association with current limiter GV1 L3)													
Circuit-breaker type			GV2 ME										
Rating			A	01 to 06 0.1 to 1.6	07 2.5	08 4	10 6.3	14 10	16 14	20 18	21 23	22 25	32 32
Breaking capacity conforming to IEC 60947-2	230/240 V	Icu	kA	*	*	*	*	*	*	*	*	*	*
		Ics % (1)		*	*	*	*	*	*	*	*	*	*
	400/415 V	Icu	kA	*	*	*	*	*	100	100	100	100	100
		Ics % (1)		*	*	*	*	*	50	50	40	40	40
	440 V	Icu	kA	*	*	*	*	*	50	20	20	20	20
		Ics % (1)		*	*	*	*	*	75	75	75	75	75
500 V	Icu	kA	*	*	*	*	50	42	10	10	10	10	
	Ics % (1)		*	*	*	*	100	100	75	75	75	75	
Circuit-breaker type			GV2 P										
Rating			A	01 to 06 0.1 to 1.6	07 2.5	08 4	10 6.3	14 10	16 14	20 18	21 23	22 25	32 32
Breaking capacity conforming to IEC 60947-2	230/240 V	Icu	kA	*	*	*	*	*	*	*	*	*	*
		Ics % (1)		*	*	*	*	*	*	*	*	*	*
	400/415 V	Icu	kA	*	*	*	*	*	*	*	*	*	*
		Ics % (1)		*	*	*	*	*	*	*	*	*	*
	440 V	Icu	kA	*	*	*	*	*	100	100	100	100	100
		Ics % (1)		*	*	*	*	*	50	50	50	50	50
500 V	Icu	kA	*	*	*	*	100	100	100	100	100	100	
	Ics % (1)		*	*	*	*	50	50	50	50	50	50	
690 V (3)	Icu = Ics	kA	*	50	50	50	50	50	50	50	50	50	
Circuit-breaker type			GV2 ME										
Rating			A	01 to 06 0.1 to 1.6	07 2.5	08 4	10 6.3	14 10	16 14	20 18	21 23	22 25	32 32
Cable protection against thermal stress in the event of short-circuit (PVC insulated copper cables)	Minimum c.s.a. protected at 40 °C at Isc max.	1 mm <sup>2</sup>		•	•	•	≤ 10 kA	≤ 6 kA	(2)	(2)	(2)	(2)	(2)
		1.5 mm <sup>2</sup>		•	•	•	≤ 20 kA	≤ 10 kA	(2)	(2)	(2)	(2)	(2)
		2.5 mm <sup>2</sup>		•	•	•	•	•	•	•	•	•	(2)
		4...6 mm <sup>2</sup>		•	•	•	•	•	•	•	•	•	•

★ > 100 kA  
 • Cable c.s.a. protected  
 (1) As % of Icu  
 (2) Cable c.s.a. not protected  
 (3) With limiter LA9 LB920

Breaking capacity of GV3 P and GV3 ME80												
Motor circuit-breaker type			A	GV3 P						GV3 ME80		
				13	18	25	32	40	50	65	80	
Rating			A	13	18	25	32	40	50	65	80	
Breaking capacity conforming to IEC 60947-2	230/240 V	Icu	kA	100	100	100	100	100	100	100	100	
		Ics % (1)		100	100	100	100	100	100	100	100	
	400/415 V	Icu	kA	100	100	100	100	50	50	50	15	
		Ics % (1)		50	50	50	50	50	50	50	50	
	440 V	Icu	kA	50	50	50	50	50	50	50	10	
		Ics % (1)		50	50	50	50	50	50	50	60	
	500 V	Icu	kA	12	12	12	12	10	10	10	4	
		Ics % (1)		50	50	50	50	50	50	50	100	
	690 V	Icu	kA	6	6	6	6	5	5	5	2	
		Ics % (1)		50	50	50	50	60	60	60	100	
	Associated fuses, if required if Isc > breaking capacity Icu	230/240 V	aM	A	*	*	*	*	*	*	*	*
			gG	A	*	*	*	*	*	*	*	*
415 V		aM	A	*	*	*	*	125	125	125	315	
		gG	A	*	*	*	*	160	160	160	400	
440 V		aM	A	63	80	125	125	125	125	125	315	
		gG	A	80	100	160	160	160	160	160	400	
500 V		aM	A	63	63	63	63	80	80	80	200	
		gG	A	80	80	80	80	100	100	100	250	
690 V		aM	A	50	50	50	50	63	63	63	200	
		gG	A	63	63	63	63	80	80	80	250	

\* Fuse not required: breaking capacity Icn > Isc.  
(1) As % of Icu.

Breaking capacity of GV7 R											
Circuit-breaker type			A	GV7							
				RE20...RE100	RS20...RS100	RE150	RS150	RE220	RS220		
Rating				12...20 to 60...100		90...150	90...150	132...220	132...220		
Breaking capacity conforming to IEC 60947-2	230/240 V	Icu	kA	85	100	85	100	85	100		
		Ics % (1)		100	100	100	100	100	100		
	400/415 V	Icu	kA	36	70	35	70	35	70		
		Ics % (1)		100	100	100	100	100	100		
	440 V	Icu	kA	36	65	35	65	35	65		
		Ics % (1)		100	100	100	100	100	100		
	500 V	Icu	kA	18	50	30	50	30	50		
		Ics % (1)		100	100	100	100	100	100		
	690 V	Icu	kA	8	10	8	10	8	10		
		Ics % (1)		100	100	100	100	100	100		
	Cable protection against thermal stress in the event of short-circuit (PVC insulated copper cables)	Minimum c.s.a. protected at 40 °C at Isc max.	4 mm <sup>2</sup>		≤ 6 kA	≤ 6 kA	(2)	(2)	(2)	(2)	
			6 mm <sup>2</sup>		●	≤ 25 kA	(2)	(2)	(2)	(2)	
10...50 mm <sup>2</sup>				●	●	●	●	●	●		

(1) As % of Icu.  
 ● Cable c.s.a. protected.  
 (2) Cable c.s.a. not protected.

Environment		GV2 LE		GV2 L		
<b>Circuit-breaker type</b>		GV2 LE		GV2 L		
<b>Conforming to standards</b>		IEC 60947-1, 60947-2, EN 60204, NF C 63-650, NF C63-120, 79-130, VDE 0113, 0660, UL 1077.				
<b>Product certifications</b>		UL, CSA, CCC		UL, CSA, CCC, BV, DNV, GL, LROS, RINA		
<b>Protective treatment</b>		"TH"		"TH"		
<b>Shock resistance</b>	Conforming to IEC 60068-2-27	30 gn		30 gn		
<b>Vibration resistance</b>	Conforming to IEC 60068-2-6	5 gn (5 to 150 Hz)		5 gn (5 to 150 Hz)		
<b>Ambient air temperature</b>	Storage	°C	- 40...+ 80		- 40...+ 80	
	Operation	°C	- 20...+ 60		- 20...+ 60	
<b>Flame resistance</b>	Conforming to IEC 60695-2-1	°C	960		960	
<b>Maximum operating altitude</b>		m	2000		2000	
<b>Operating position</b>						
<b>Connection</b> (Max. number of conductors x c.s.a)	Solid cable	mm <sup>2</sup>	<b>Min.</b> 2 x 1	<b>Max.</b> 2 x 6	<b>Min.</b> 2 x 1	<b>Max.</b> 2 x 6
	Flexible cable without cable end	mm <sup>2</sup>	2 x 1.5	2 x 6	2 x 1.5	2 x 6
	Flexible cable with cable end	mm <sup>2</sup>	2 x 1	2 x 4	2 x 1	2 x 4
<b>Tightening torque</b>		N.m	1.7		1.7	
<b>Suitable for isolation</b>	Conforming to IEC 60947-1 § 7-1-6		Yes		Yes	
<b>Resistance to mechanical impact</b>		J	0.5		0.5	
Technical characteristics						
<b>Utilisation category</b>	Conforming to IEC 60947-2		A		A	
	Conforming to IEC 60947-4-1		AC-3		AC-3	
<b>Rated operational voltage (U<sub>e</sub>)</b>	Conforming to IEC 60947-2	V	690		690	
<b>Rated insulation voltage (U<sub>i</sub>)</b>	Conforming to IEC 60947-2	V	690		690	
<b>Rated operational frequency</b>	Conforming to IEC 60947-2	Hz	50/60		50/60	
<b>Rated impulse withstand voltage (U<sub>imp</sub>)</b>	Conforming to IEC 60947-2	kV	6		6	
<b>Total power dissipated per pole</b>		W	1.8		1.8	
<b>Mechanical durability</b> (C.O.: Closing, Opening)	For AC-3 duty	C.O.	100 000		100 000	
<b>Electrical durability for AC-3/415V duty</b> (C.O.: Closing, Opening)		C.O.	100 000		100 000	
<b>Duty class</b> (maximum operating rate)		C.O./h	40		40	
<b>Rated duty</b>	Conforming to IEC 60947-4-1		Continuous duty		Continuous duty	

# TeSys protection components

## Magnetic motor circuit-breakers

### GV2 LE and GV2 L

Circuit-breaker type			GV2 LE										GV2 L													
			03 to 06	07	08	10	14	16	20	22	32	03 to 05	06 & 07	08	10	14	16	20	22	32						
<b>Rating</b>	<b>A</b>		0.4 to 1.6	2.5	4	6.3	10	14	16	18	25	32	50	50	0.4 to 1	1.6 to 2.5	4	6.3	10	14	16	18	25	32		
<b>Breaking capacity</b> conforming to IEC 60947-2	230/240 V	Icu	kA	*	*	*	*	*	*	*	*	*	50	50	*	*	*	*	*	*	*	*	*	50	50	
		Ics % (1)		*	*	*	*	*	*	*	*	*	100	100	*	*	*	*	*	*	*	*	*	100	100	
	400/415 V	Icu	kA	*	*	*	*	*	15	15	15	10	*	*	*	*	*	*	*	*	*	*	50	50	50	50
		Ics % (1)		*	*	*	*	*	50	50	40	50	*	*	*	*	*	*	*	*	*	*	50	50	50	50
	440 V	Icu	kA	*	*	*	50	15	8	8	6	6	*	*	*	*	*	*	*	*	*	20	20	20	20	20
		Ics % (1)		*	*	*	100	100	50	50	50	50	*	*	*	*	*	*	*	*	*	75	75	75	75	75
	500 V	Icu	kA	*	*	*	50	10	6	6	4	4	*	*	*	*	*	*	*	*	*	10	10	10	10	10
		Ics % (1)		*	*	*	100	100	75	75	75	75	*	*	*	*	*	*	*	*	*	100	75	75	75	75
	690 V	Icu	kA	*	3	3	3	3	3	3	3	3	*	4	4	4	4	4	4	4	4	4	4	4	4	4
		Ics % (1)		*	75	75	75	75	75	75	75	75	*	100	100	100	100	100	100	100	100	100	100	100	100	100
<b>Associated fuses (if required)</b> if Isc > breaking capacity Icu conforming to IEC 60947-2 amendment 1	230/240 V	aM	A	*	*	*	*	*	*	*	*	*	80	80	*	*	*	*	*	*	*	*	*	100	100	
		gG	A	*	*	*	*	*	*	*	*	*	100	100	*	*	*	*	*	*	*	*	*	125	125	
	400/415 V	aM	A	*	*	*	*	*	63	63	80	80	*	*	*	*	*	*	*	*	*	80	100	100	100	
		gG	A	*	*	*	*	*	80	80	100	100	*	*	*	*	*	*	*	*	*	100	125	125	125	
	440 V	aM	A	*	*	*	50	50	50	50	63	63	*	*	*	*	*	*	*	*	*	50	63	80	80	80
		gG	A	*	*	*	63	63	63	63	80	80	*	*	*	*	*	*	*	*	*	63	80	100	100	100
	500 V	aM	A	*	*	*	50	50	50	50	50	50	*	*	*	*	*	*	*	*	*	50	50	50	50	50
		gG	A	*	*	*	63	63	63	63	63	63	*	*	*	*	*	*	*	*	*	63	63	63	63	63
	690 V	aM	A	*	16	25	32	32	40	40	40	40	*	20	25	40	40	40	40	40	40	50	50	50	50	50
		gG	A	*	20	32	40	40	50	50	50	50	*	25	32	50	50	63	63	63	63	63	63	63	63	
<b>Cable protection against thermal stress in the event of short-circuit</b> (PVC insulated copper cables) Minimum c.s.a. protected at 40 °C and at Isc max.	1 mm <sup>2</sup>	kA	•	•	•	≤10	≤6	(2)	(2)	(2)	(2)	•	•	•	•	•	•	•	•	•	•	•	•	•	•	
	1.5 mm <sup>2</sup>	kA	•	•	•	≤20	≤10	(2)	(2)	(2)	(2)	•	•	•	•	•	•	•	•	•	•	•	•	•	•	
	2.5 mm <sup>2</sup>		•	•	•	•	•	•	•	•	•	(2)	•	•	•	•	•	•	•	•	•	•	•	•	(2)	
	4...6 mm <sup>2</sup>		•	•	•	•	•	•	•	•	•	•	•	•	•	•	•	•	•	•	•	•	•	•	•	

★ > 100 kA  
 • Cable c.s.a. protected  
 (1) As % of Icu  
 (2) Cable c.s.a. not protected

Environment		GV3 L		GK3 EF80		
<b>Circuit-breaker type</b>		GV3 L		GK3 EF80		
<b>Conforming to standards</b>		IEC/EN 60947-1, 60947-2		IEC 60947-2, EN 60204		
<b>Protective treatment</b>		"TH"		"TC"		
<b>Degree of protection</b>	Conforming to IEC 60529	IP 20		IP 20		
<b>Shock resistance</b>	Conforming to IEC 60068-2-27	On : 15 gn -11 ms Off : 30 gn -11 ms		22 gn -20 ms		
<b>Vibration resistance</b>	Conforming to IEC 60068-2-6	4 gn (5...300 Hz)		2.5 gn (0...25 Hz)		
<b>Flame resistance</b>	Conforming to IEC 60695-2-1	°C	960	960		
<b>Ambient air temperature</b>	Storage	°C	- 40...+ 80	- 40...+ 80		
	Operation	°C	- 20...+ 60 (1)	- 20...+ 70 open mounted		
<b>Maximum operating altitude</b>		m	3000	3000		
<b>Operating position</b>	Without derating, in relation to normal vertical mounting plane (2)				Any position	
<b>Connection</b> (Max. number of conductors x c.s.a)	Solid cable	mm <sup>2</sup>	<b>Min.</b> 2 x 1	<b>Max.</b> 1 x 25 1 x 35	<b>Min.</b> 1 x 2.5	<b>Max.</b> 1 x 35
	Flexible cable without cable end	mm <sup>2</sup>	2 x 1	1 x 25 1 x 35	1 x 2.5 or 2 x 2.5	1 x 25 or 2 x 16
	Flexible cable with cable end	mm <sup>2</sup>	2 x 1	1 x 25 1 x 35	1 x 2.5 or 2 x 2.5	1 x 25 or 2 x 16
<b>Tightening torque</b>		N.m	5	5 : 25 mm <sup>2</sup> 8 : 35 mm <sup>2</sup>	5	
<b>Suitable for isolation</b> conforming to IEC 60947-1 § 7-1-6			Yes		Yes	

Technical characteristics		GV3 L		GK3 EF80	
<b>Rated insulation voltage (U<sub>i</sub>)</b>	Conforming to IEC 60947-2	V	690	750	
<b>Rated impulse withstand voltage (U<sub>imp</sub>)</b>	Conforming to IEC 60947-2	kV	6	10	
<b>Rated operational voltage (U<sub>e</sub>)</b>	Conforming to IEC 60947-2	V	690	690	
<b>Rated operational frequency</b>		Hz	50/60	50...60	
<b>Electrical durability for AC-3/415V duty</b> (C.O.: Close - Open)		C.O.	50 000	1500	
<b>Mechanical durability</b> (C.O.: Closing, Opening)		C.O.	50 000	20 000	
<b>Maximum operating rate</b>		C.O./h	25	40	
<b>Operating threshold of magnetic trips</b>			14 I max	3363	
<b>Utilisation category</b>	Conforming to IEC 60947-2		A	A	

(1) Leave a space of 9 mm between 2 circuit-breakers: either an empty space or side-mounting add-on contact blocks. Side by side mounting is possible up to 40 °C.  
 (2) When mounting on a vertical rail, fit a stop to prevent any slippage.



Breaking capacity of GV3 L and GK3 EF80										
Type				GV3 L25	GV3 L32	GV3 L40	GV3 L50	GV3 L65	GK3 EF80	
Breaking capacity of the circuit-breaker only or of the circuit-breaker combined with a thermal overload relay	230/240 V	Icu	kA	100	100	100	100	100	50	
		Ics % (1)		100	100	100	100	100	40	
	400/415 V	Icu	kA	100	100	50	50	50	35	
		Ics % (1)		50	50	50	50	50	25	
	440 V	Icu	kA	50	50	50	50	50	25	
		Ics % (1)		50	50	50	50	50	30	
	500 V	Icu	kA	12	12	10	10	10	15	
		Ics % (1)		50	50	50	50	50	30	
	690 V	Icu	kA	6	6	5	5	5	6	
		Ics % (1)		50	50	60	60	60	50	
	Associated fuses (if required) for use with circuit-breaker only or circuit-breaker combined with a thermal overload relay if Isc > breaking capacity	230/240 V	aM	A	★	★	★	★	★	200
			gG	A	★	★	★	★	★	315
415 V		aM	A	★	★	★	★	125	200	
		gG	A	★	★	★	★	160	250	
440 V		aM	A	63	80	125	125	125	160	
		gG	A	80	100	160	160	160	250	
500 V		aM	A	63	63	63	63	80	160	
		gG	A	80	80	80	80	100	200	
690 V		aM	A	50	50	50	50	63	125	
		gG	A	63	63	63	63	80	160	
Use of circuit-breakers without fuses				Minimum cable length (in metres) limiting the maximum short-circuit current to 35 kA maximum, so enabling breakers <b>GK3 EF80</b> to be used without fuses						
Cable c.s.a.			mm <sup>2</sup>	≤ 25	35	50	70	95	120	
Isc (rms) 3-phase, incoming (Ue = 415 V)		50 kA	m	5	6	8	10	13	15	
		45 kA	m	5	5	7	8	10	12	
		40 kA	m	5	5	5	5	8	9	
		37 kA	m	5	5	5	5	5	5	

★ Fuse not required: breaking capacity Icn > Isc.  
 (1) As % of Icu

# TeSys protection components

## Thermal-magnetic motor circuit-breakers

### GV2, GV3 P and GV3 L

### Auxiliary contacts

Type of contacts			Instantaneous auxiliary GV AN, GV AD							Fault signalling GV AD, GV AM11 (1)				Instantaneous auxiliary GV AE					
<b>Rated insulation voltage (Ui)</b> (associated insulation coordination)	Conforming to IEC 60947-1	V	690							690				250 (690 in relation to main circuit)					
	Conforming to CSA C22-2 n° 14 and UL 508	V	600							300				300					
<b>Conventional thermal current (Ith)</b>	Conforming to IEC 60947-5-1	A	6							2.5				2.5					
	Conforming to CSA C22-2 n° 14 and UL 508	A	5							1				1					
<b>Mechanical durability</b> (C.O.: Close - Open)		C.O.	100 000							1000				100 000					
<b>Operational power and current</b> conforming to IEC 60947-5-1. a.c. operation			AC-15/100 000 C.O.							AC-14/1000 C.O.				AC-15/100 000 C.O.					
	Rated operational voltage (Ue)	V	48	110	230	380	440	500	690	24	48	110	230	240	24	48	110	230	240
	Operational power, normal conditions	VA	300	500	720	850	650	500	400	36	48	72	72	48	60	120	120		
	Occasional breaking and making capacities, abnormal conditions	kVA	3	7	13	15	13	12	9	0.22	0.3	0.45	0.45	0.48	0.6	1.27	2.4		
	Rated operational current (Ie)	A	6	4.5	3.3	2.2	1.5	1	0.6	1.5	1	0.5	0.3	2	1.25	1	0.5		
<b>Operational power and current</b> conforming to IEC 60947-5-1. d.c. operation			DC-13/100 000 C.O.							DC-13/1000 C.O.				DC-13/100 000 C.O.					
	Rated operational voltage (Ue)	V	24	48	60	110	240	—	—	24	48	60	—	24	48	60	—		
	Operational power, normal conditions	W	140	240	180	140	120	—	—	24	15	9	—	24	15	9	—		
	Occasional breaking and making capacities, abnormal conditions	W	240	360	240	210	180	—	—	100	50	50	—	100	50	50	—		
	Rated operational current (Ie)	A	6	5	3	1.3	0.5	—	—	1	0.3	0.15	—	1	0.3	0.15	—		
<b>Low power switching reliability of contact</b>			GV AE: Number of failures for "n" million operating cycles (17 V-5 mA); = 10 <sup>-6</sup>																
<b>Minimum operational conditions</b> d.c. operation		V	17																
		mA	5																
<b>Short-circuit protection</b>			By GB2 CB●● circuit-breaker (rating according to operational current for Ue ≤ 415 V) or by gG fuse 10 A max											GB2 CB06 or gG fuse 10 A max					
<b>Cabling, screw clamp terminals</b>	Number of conductors		1			2													
	Solid cable	mm <sup>2</sup>	1...2.5			1...2.5													
	Flexible cable without cable end	mm <sup>2</sup>	0.75...2.5			0.75...2.5													
	Flexible cable with cable end	mm <sup>2</sup>	0.75...1.5			0.75...1.5													
	Tightening torque	N.m	1.4 max			1.4 max													
<b>Cabling, spring terminal connections</b>	Flexible cable without cable end	mm <sup>2</sup>	GV AN only 0.75...2.5			0.75...2.5			—				0.75...1.5						

Operation of instantaneous auxiliary contacts

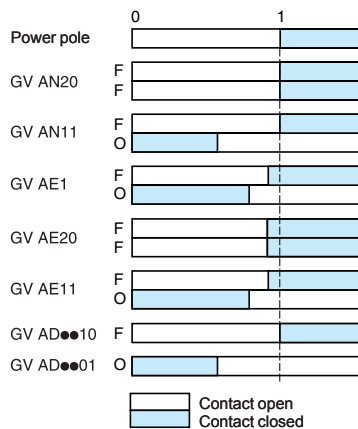

Operation of fault signalling contacts

**GV AM11**  
Change of state following tripping on short-circuit.

**GV AD10●● and GV AD01●●**  
Change of state following tripping on short-circuit, overload or undervoltage.

(1) For application example of fault signalling contact and short-circuit signalling contact, see page 102.  
(2) Add an RC circuit type LA4 D to the load terminals, see page 169.

# TeSys protection components

## Thermal-magnetic motor circuit-breakers

### GV3 ME80

#### Auxiliary contacts

Type of contacts			Instantaneous auxiliary contacts GV3 A01...A07						Fault signalling contacts GV3 A08 and A09							
Rated insulation voltage (Ui)	Conforming to IEC 60947-1	V	690						690							
	Conforming to CSA C22-2 n° 14, UL 508	V	600 (B600)						600 (B600)							
Conventional rated thermal current (Ith)	Conforming to IEC 60947-5-1	A	6						6							
	Conforming to CSA C22-2 n° 14, UL 508	A	5 (B600)						5 (B600)							
Mechanical durability (C.O.: Close - Open)		C.O.	100 000						1000							
Operational power and current conforming to IEC 60947-5-1 a.c. operation	Rated operational voltage (Ue)	V	48	110	220	380	440	500	690	48	110	220	380	440	500	690
	Operational power	VA	AC-11/100 000 C.O.						AC-11/1000 C.O.							
	Occasional breaking and making capacities	kVA	4	12	20	20	15	15	10	2.4	8	12	15	12	12	8
	Operational current (Ie)	A	6	4.5	3.5	2.2	1.5	1.5	0.6	5	3.6	3.5	2.2	1	1	0.3
Operational power and current conforming to IEC 60947-5-1 d.c. operation	Rated operational voltage (Ue)	V	24	48	60	110	220	24	48	60	110	220				
	Operational power	W	DC-11/100 000 C.O.						DC-11/1000 C.O.							
	Occasional breaking and making capacities	W	240	360	240	210	180	180	180	135	105	90				
	Operational current (Ie)	A	6	5	3	1.3	0.5	5	2.5	1.5	0.7	0.3				
Short-circuit protection			By <b>GB2 CB08</b> circuit-breaker or gG fuse, 6A max													
Connection	Number of conductors		1			2										
	Solid cable	mm <sup>2</sup>	1...2.5			1...2.5										
	Flexible cable without cable end	mm <sup>2</sup>	0.75...2.5			0.75...2.5										
	Flexible cable with cable end	mm <sup>2</sup>	0.75...2.5			0.75...1.5										

**Contact operation**

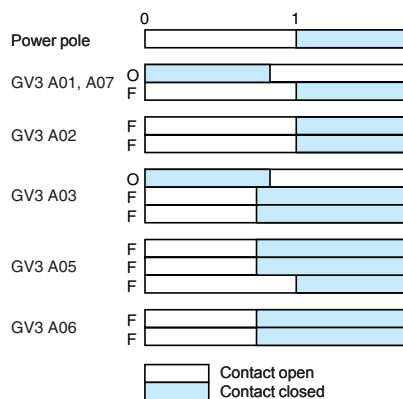

GV3 A08 and A09 change state following tripping on short-circuit or overload

Auxiliary contact characteristics																
Type of contacts			GV7 AE11							GV7 AB11						
<b>Rated insulation voltage</b> (Ui) (associated insulation coordination)	Conforming to IEC 60947-1	<b>V</b>	690							690						
<b>Conventional thermal current</b> (Ith)	Conforming to IEC 60947-5-1	<b>A</b>	6							6						
<b>Mechanical durability</b> (C.O.: Close - Open)		<b>C.O.</b>	50 000							50 000						
<b>Operational current</b> conforming to IEC 60947-5-1 a.c. operation	Rated operational voltage (Ue)	<b>V</b>	AC-12 or AC-15. 50 000 C.O.							AC-12 or AC-15. 50 000 C.O.						
	Rated operational current (Ie)	AC-12	<b>A</b>	6	6	6	6	6	6	6	5	5	5	5	5	5
		AC-15	<b>A</b>	6	6	5	4	3	3	0.1	5	5	4	3	2.5	2.5
<b>Operational current</b> conforming to IEC 60947-5-1 d.c. operation	Rated operational voltage (Ue)	<b>V</b>	DC-12 or DC-14. 50 000 C.O.							DC-12 or DC-14. 50 000 C.O.						
	Rated operational current (Ie)	DC-12	<b>A</b>	2.5	2.5	0.8	0.3	2	2	0.5	–					
		DC-14	<b>A</b>	1	0.2	0.5	0.03	0.5	0.1	0.25	–					
<b>Minimum operational conditions</b> d.c. operation		<b>V</b>	17							12						
		<b>mA</b>	5							5						
<b>Short-circuit protection</b>			By <b>GB2 CB●●</b> circuit-breaker (rating according to operational current for Ue ≤ 415 V) or gG fuse, 10 A max.													
<b>Cabling</b>	Solid cable	<b>mm<sup>2</sup></b>	1 x 1.5 conductor							1 x 1.5 conductor						
	Flexible cable without cable end	<b>mm<sup>2</sup></b>	1 x 1.5 conductor							1 x 1.5 conductor						
	Flexible cable with cable end	<b>mm<sup>2</sup></b>	1 x 1.5 conductor							1 x 1.5 conductor						

Characteristics of Start-Stop and fault signalling contacts								
<b>Rated insulation voltage (Ui)</b>	Conforming to IEC 60947-1	<b>V</b>	500					
<b>Rated operational voltage (Ue)</b>	Conforming to IEC 60947-1	<b>V</b>	500					
<b>Conventional thermal current (Ith)</b>	Conforming to IEC 60947-5-1	<b>A</b>	6					
<b>Operational power and current</b> conforming to IEC 60947-5-1 a.c. operation (C.O.: Close - Open)	Rated operational voltage (Ue)	<b>V</b>	AC-15. 20 000 C.O.					
	Operational power	<b>VA</b>	<b>48</b>	<b>110/127</b>	<b>220/240</b>	<b>380/415</b>	<b>440</b>	<b>500</b>
	Occasional breaking and making capacities	<b>VA</b>	4000	12 000	20 000	20 000	15 000	15 000
	Rated operational current (Ie)	<b>A</b>	6	4.5	3.5	2.2	1.5	1.5
<b>Operational power and current</b> conforming to IEC 60947-5-1 d.c. operation (C.O.: Close - Open)	Rated operational voltage (Ue)	<b>V</b>	DC-13. 1000 C.O.					
	Operational power	<b>W</b>	<b>24</b>	<b>48</b>	<b>60</b>	<b>110</b>	<b>220</b>	
	Occasional breaking and making capacities	<b>W</b>	240	280	240	210	180	
	Rated operational current (Ie)	<b>A</b>	6	5	3	1.3	0.5	
<b>Short-circuit protection</b>	Conforming to IEC 60947-5-1		By <b>GB2 CB08</b> circuit-breaker or gG fuse, 6A max					
<b>Cabling</b>	Solid cable	<b>mm<sup>2</sup></b>	1 x 1...4 conductor					
	Flexible cable without cable end	<b>mm<sup>2</sup></b>	1 x 2.5 conductor					
	Flexible cable with cable end	<b>mm<sup>2</sup></b>	1 x 1...2.5 conductor or 2 x 1...2.5 conductors					
<b>Tightening torque</b>		<b>N.m</b>	0.8					

Characteristics of electric trips									
Circuit-breaker type			GV2 ME, GV2 P GV3 P, GV3 L		GV2 ME only	GV3 ME80		GV7 R	
Type of trip			GV AU	GV AS	GV AX (1)	GV3 B	GV3 D	GV7 AU	GV7 AS
Rated insulation voltage (Ui)	Conforming to IEC 60947-1	V	690	690	500	690	690	690	690
	Conforming to CSA C22-2 n° 14, UL 508	V	600	600	–	600 (B600)	600 (B600)	600	600
Operational voltage	Conforming to IEC 60947-1	V	0.85... 1.1 Un	0.7... 1.1 Un	0.85... 1.1 Un	0.8...1.1 Un		0.85... 1.1 Un	0.7... 1.1 Un
Drop-out voltage		V	0.7... 0.35 Un	0.75... 0.2 Un	0.7... 0.35 Un	0.7...0.35 Un		0.35... 0.7 Ue	0.2... 0.75 Ue
Inrush consumption	~	VA	12	14	12	12		< 10	
	≡	W	8	10.5	8	7		< 5	
Sealed consumption	~	VA	3.5	5	3.5	7		< 5	
	≡	W	1.1	1.6	1.1	2.5		< 5	
Operating time	Conforming to IEC 60947-1	ms	From the moment the voltage reaches its operational value until opening of the circuit-breaker. 10...15			10	15	< 50	
On-load factor			100 %			100 %		100 %	
Cabling	Number of conductors		2 or 4			1 or 2		1	
	Solid cable	mm <sup>2</sup>	1...2.5			1...2.5		1.5	
	Flexible cable without cable end	mm <sup>2</sup>	0.75...2.5			0.75...2.5		1.5	
	Flexible cable with cable end	mm <sup>2</sup>	0.75...1.5			0.75...2.5		1	
Tightening torque		N.m	1.4 max			1.2		1.2	
Mechanical durability (C.O.: Close - Open)		C.O.	30 000 (GV2 ME and GV2 P) 10 000 (GV3 P and GV3 L)			50 % of the mechanical durability of the circuit-breaker			

(1) Wiring scheme of undervoltage trip for dangerous machines (conforming to INRS) on GV2 ME only, see page 102.

Characteristics of 3-pole busbars GV2 G●●● and GV3 G●64				
			GV2 G●●●	GV3 G●64
Rated insulation voltage (Ui)	Conforming to IEC 60947-1	V	690	690
Conventional thermal current (Ith)	Conforming to IEC 60439-1	A	63	115
Permissible peak current (I peak)		kA	11	20
Permissible thermal limit (I²t)		kA²s	104	300
Degree of protection	Conforming to IEC 60529		IP 20	IP 20
Terminal block			Yes	–

Characteristics of terminal blocks GV2 G05 and GV1 G09 (for GV2 ME and GV2 P)				
Rated insulation voltage (Ui)	Conforming to IEC 60947-1	V	690	
Conventional thermal current (Ith)	Conforming to IEC 60439-1	A	63	
Degree of protection	Conforming to IEC 60529		IP 20	
Connection	Solid cable	mm²	1 x 1.5 to 25 conductor or 2 x 1.5 to 10 conductors	
	Flexible cable without cable end	mm²	1 x 1.5 to 25 conductor or 2 x 2.5 to 10 conductors	
	Flexible cable with cable end	mm²	1 x 1.5 to 16 conductor or 2 x 1.5 to 4 conductors	
Tightening torque	Connector	N.m	2.2	
	Screw clamp terminals	N.m	1.7	

Characteristics of current limiters (GV2 ME and GV2 P)						
Type			GV1 L3		LA9 LB920	
Rated insulation voltage (Ui)	Conforming to IEC 60947-1	V	690		690	
Conventional thermal current (Ith)	Conforming to IEC 60947-1	A	63		63	
Operating threshold	rms current	A	1500 (non adjustable threshold)		1000 (non adjustable threshold)	
Connection			<b>1 conductor</b>	<b>2 conductors</b>	<b>1 conductor</b>	<b>2 conductors</b>
	Solid cable	mm²	1.5...25	1.5...10	1.5...25	1.5...10
	Flexible cable without cable end	mm²	1.5...25	2.5...10	1.5...25	1.5...10
	Flexible cable with cable end	mm²	1.5...16	1.5...4	1.5...16	1.5...4
Tightening torque		N.m	2.2			

#### Thermal-magnetic tripping curves for GV2 ME and GV2 P

Average operating times at 20 °C related to multiples of the setting current

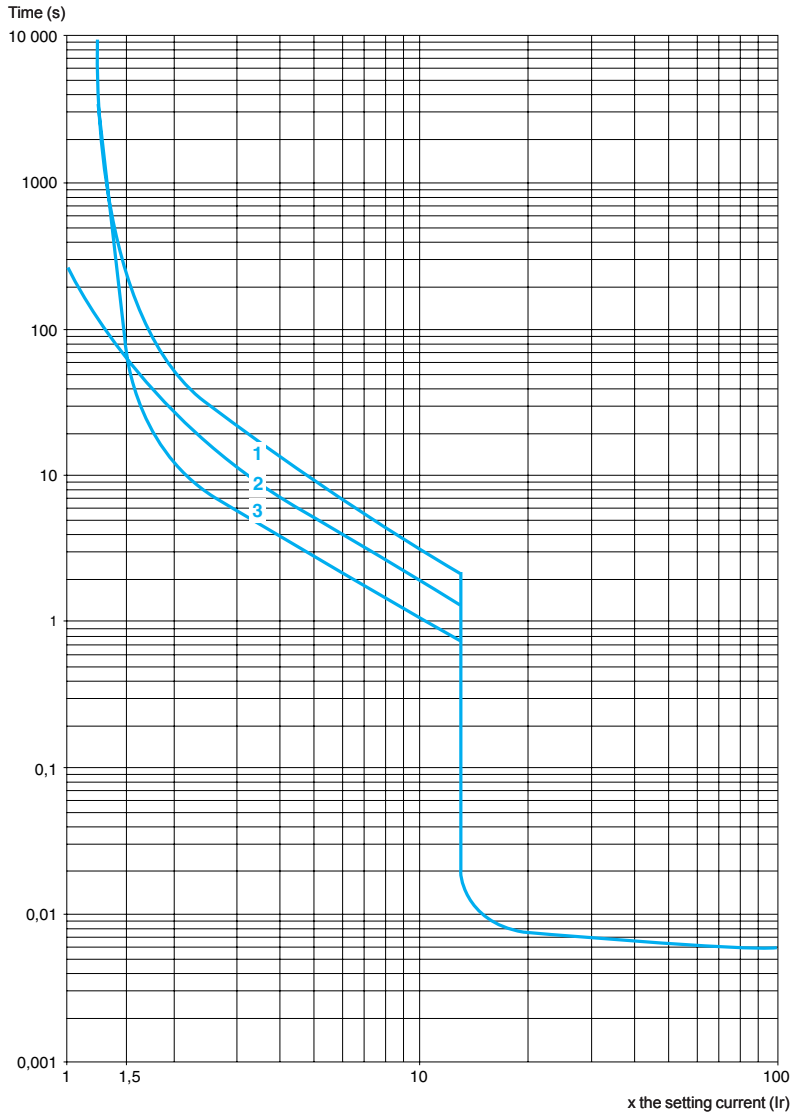

- 1 3 poles from cold state
- 2 2 poles from cold state
- 3 3 poles from hot state



## Current limitation on short-circuit for GV2 ME and GV2 P (3-phase 400/415 V)

### Dynamic stress

$I_{peak} = f(\text{prospective } I_{sc}) \text{ at } 1.05 U_e = 435 \text{ V}$

Limited peak current (kA)

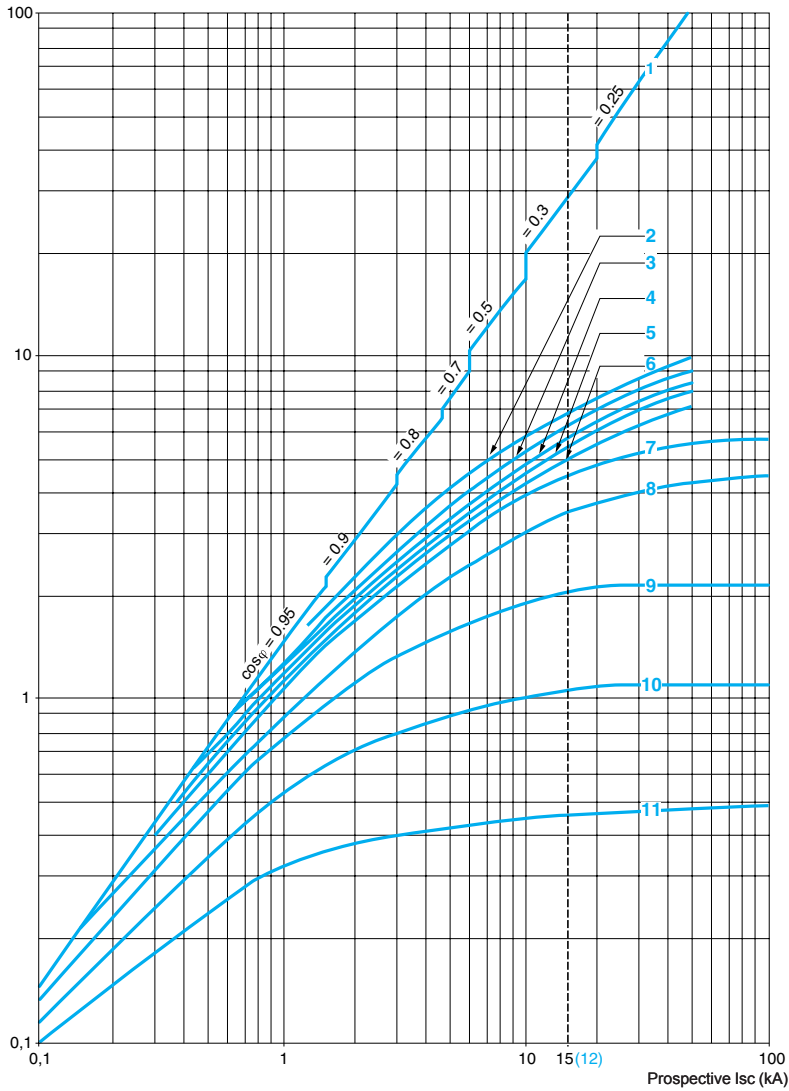

- 1 Maximum peak current
- 2 24 -32 A
- 3 20 -25 A
- 4 17 -23 A
- 5 13 -18 A
- 6 9 -14 A
- 7 6 -10 A
- 8 4 -6.3 A
- 9 2.5 -4 A
- 10 1.6 -2.5 A
- 11 1 -1.6 A
- 12 Limit of rated ultimate breaking capacity on short-circuit of GV2 ME (14, 18, 23 and 25 A ratings)

#### Thermal limit on short-circuit for GV2 ME

Thermal limit in kA<sup>2</sup>s in the magnetic operating zone

Sum of I<sup>2</sup>dt = f (prospective I<sub>sc</sub>) at 1.05 U<sub>e</sub> = 435 V

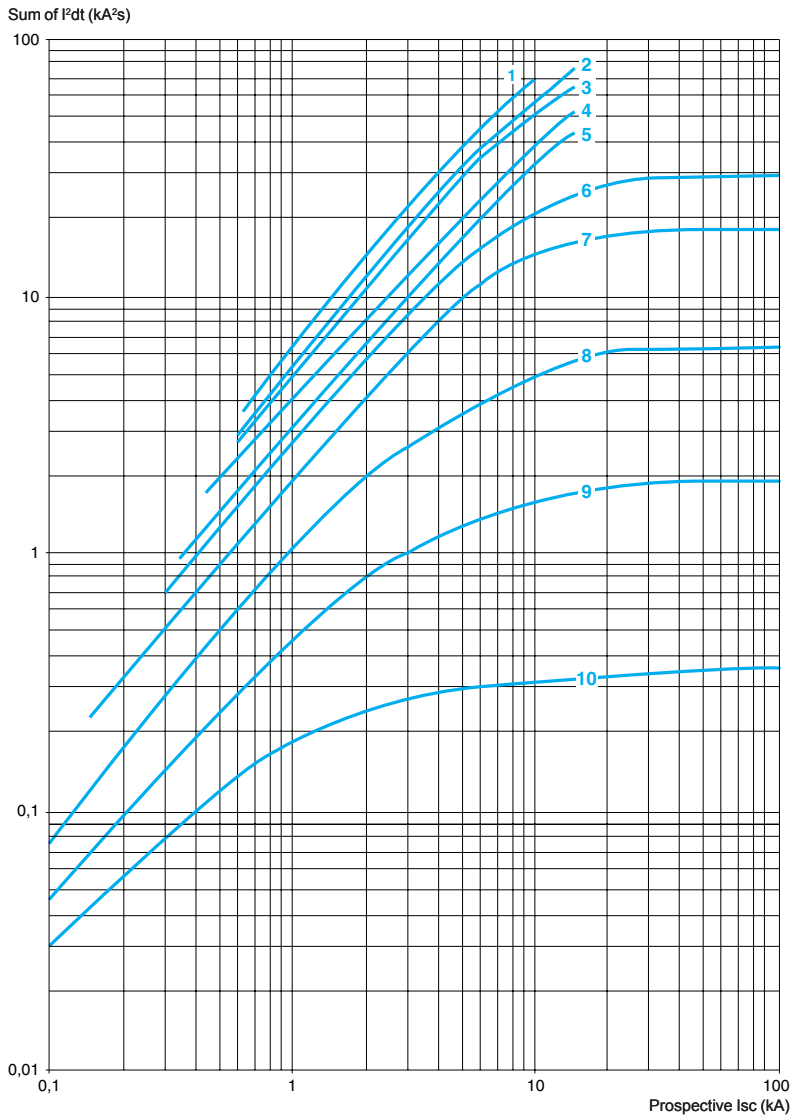

- 1 24 -32 A
- 2 20 -25 A
- 3 17 -23 A
- 4 13 -18 A
- 5 9 -14 A
- 6 6 -10 A
- 7 4 -6.3 A
- 8 2.5 -4 A
- 9 1.6 -2.5 A
- 10 1 -1.6 A

#### Thermal limit on short-circuit for GV2 P

Thermal limit in  $kA^2s$  in the magnetic operating zone

Sum of  $I^2dt = f$  (prospective  $I_{sc}$ ) at 1.05  $U_e = 435$  V

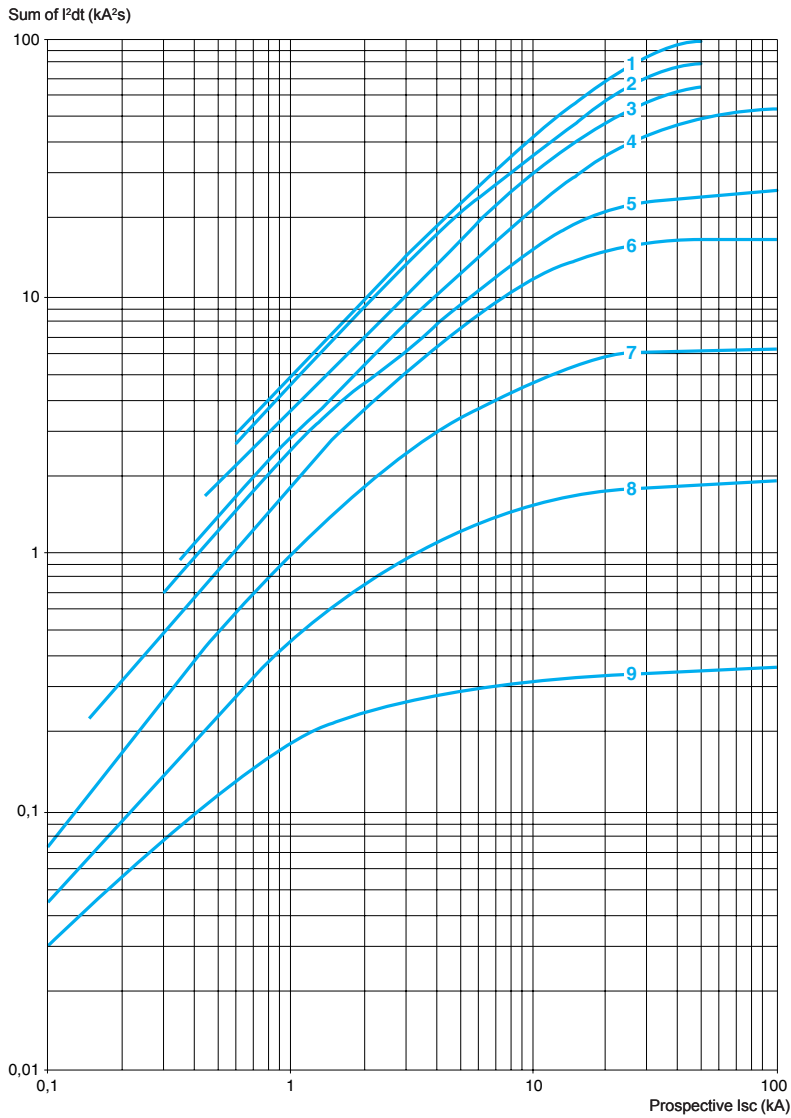

- 1 24-32 A
- 1 20-25 A
- 2 17-23 A
- 3 13-18 A
- 4 9-14 A
- 5 6-10 A
- 6 4-6.3 A
- 7 2.5-4 A
- 8 1.6-2.5 A
- 9 1-1.6 A

## Thermal-magnetic tripping curves

Average operating times at 20 °C related to multiples of the setting current

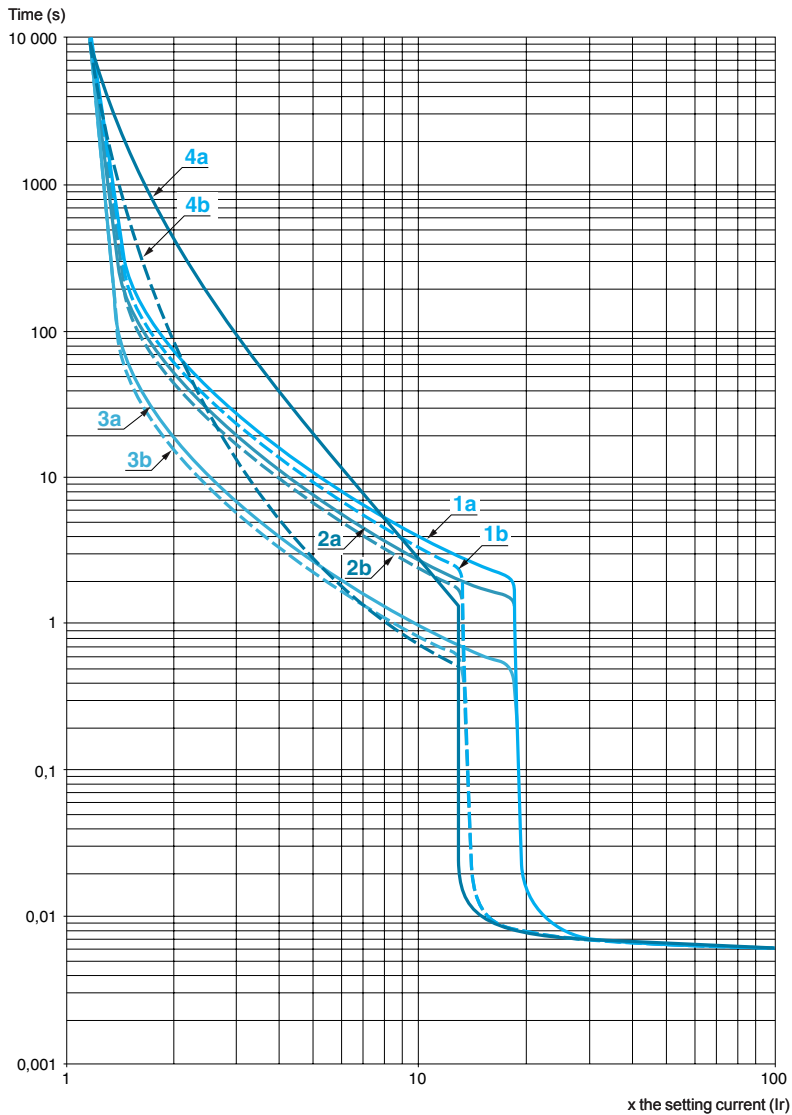

- 1a** 3 poles from cold state ( $I_r$  mini.) : GV3 P
- 1b** 3 poles from cold state ( $I_r$  maxi.) : GV3 P
- 2a** 2 poles from cold state ( $I_r$  mini.) : GV3 P
- 2b** 2 poles from cold state ( $I_r$  maxi.) : GV3 P
- 3a** 3 poles from hot state ( $I_r$  mini.) : GV3 P
- 3b** 3 poles from hot state ( $I_r$  maxi.) : GV3 P
- 4a** 3 poles from hot state ( $I_r$  mini.) : GV3 ME80
- 4b** 3 poles from hot state ( $I_r$  maxi.) : GV3 ME80

#### Current limitation on short-circuit (3-phase 400/415 V)

##### Dynamic stress

$I_{peak} = f(\text{prospective } I_{sc}) \text{ at } 1.05 U_e = 435 \text{ V}$

Limited peak current (kA)

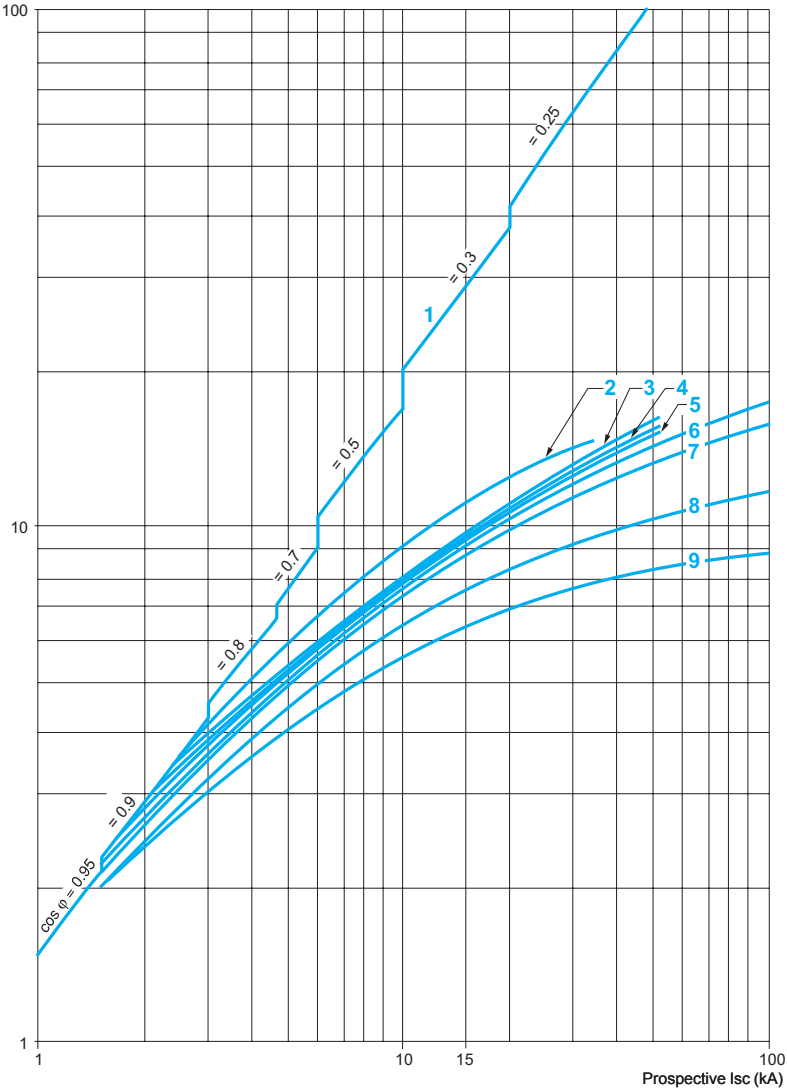

- 1 Maximum peak current
- 2 56-80 A
- 3 48-65 A
- 4 37-50 A
- 5 30-40 A
- 6 23-32 A
- 7 17-25 A
- 8 12-18 A
- 9 9-13 A

#### Maximum thermal limit on short-circuit

Thermal limit in  $kA^2s$  in the magnetic operating zone

Sum of  $I^2dt = f$  (prospective  $I_{sc}$ ) at  $1.05 U_e = 435 V$

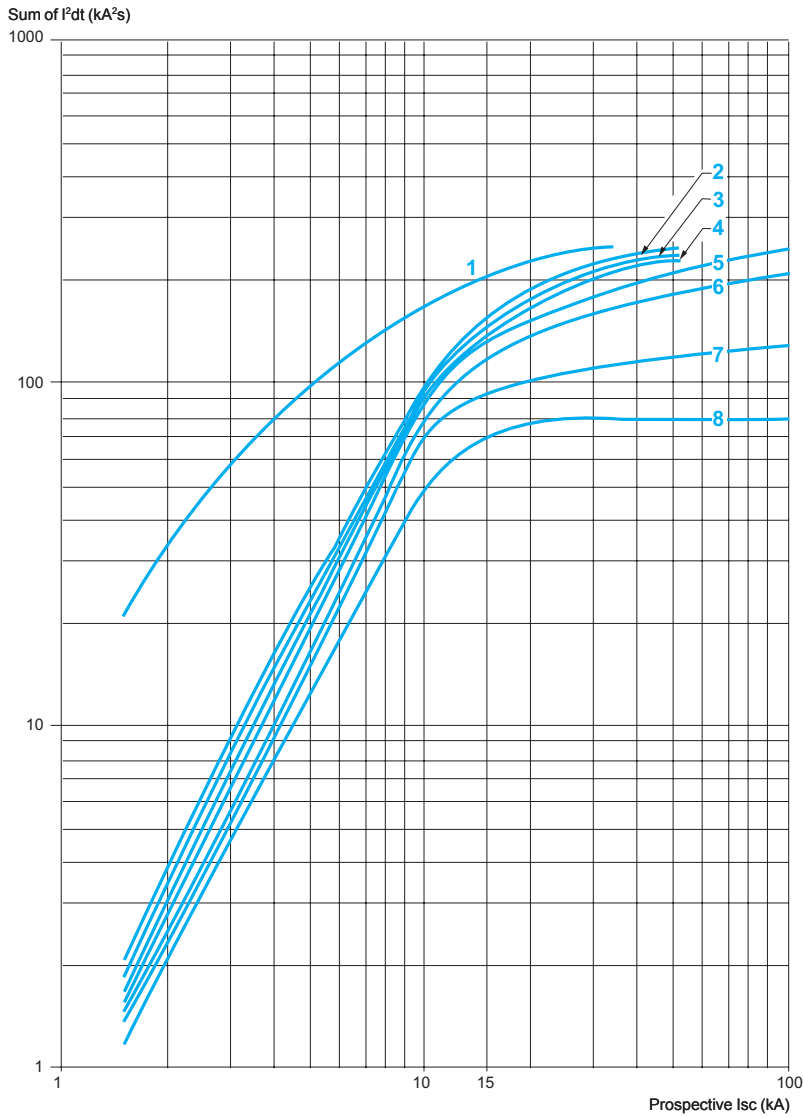

- 1 56-80 A (GV3 ME80)
- 2 48-65 A (GV3 P65)
- 3 37-50 A (GV3 P50)
- 4 30-40 A (GV3 P40)
- 5 23-32 A (GV3 P32)
- 6 17-25 A (GV3 P25)
- 7 12-18 A (GV3 P18)
- 8 9-13 A (GV3 P13)

#### Thermal-magnetic tripping curves for GV7 R

Average operating times at 20 °C related to multiples of the setting current

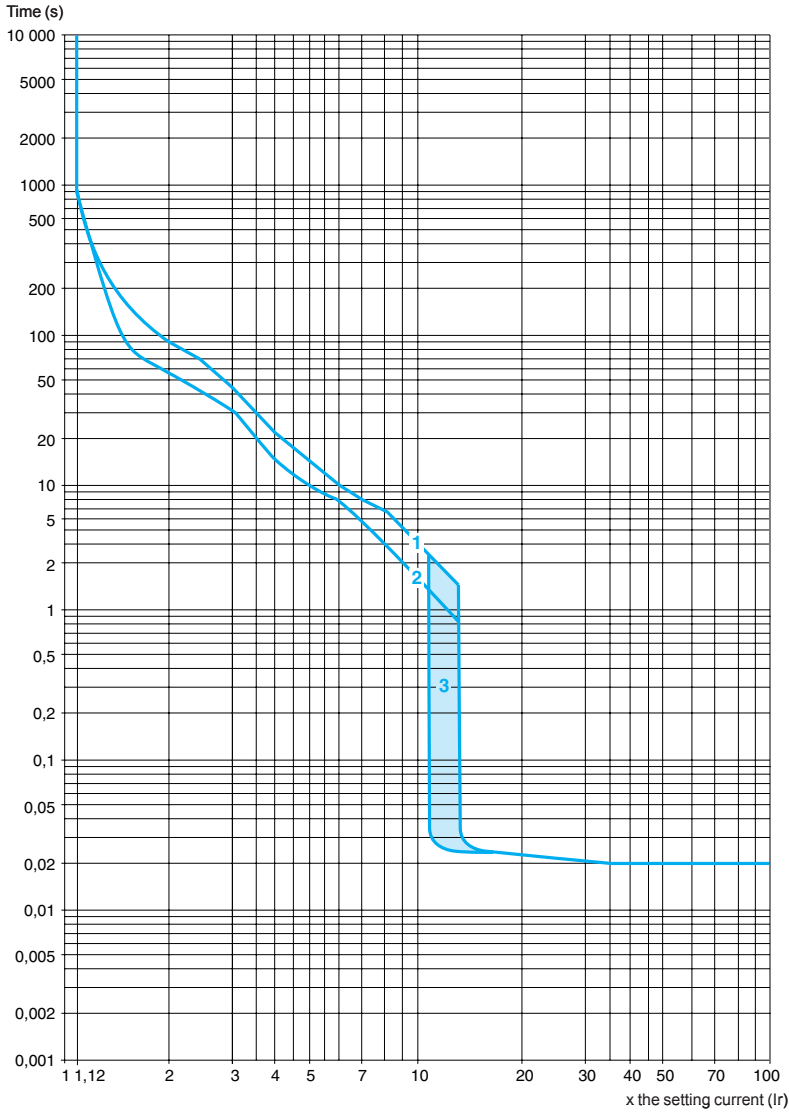

- 1 Cold state curve
- 2 Cold state curve
- 3 12...14 I<sub>r</sub>

In the event of total phase failure, tripping occurs after 4 s ± 20 %

#### Current limitation on short-circuit (3-phase 400/415 V)

##### Dynamic stress

$$I_{\text{peak}} = f(\text{prospective } I_{\text{sc}})$$

##### For GV7 RE only

Limited peak current (kA)

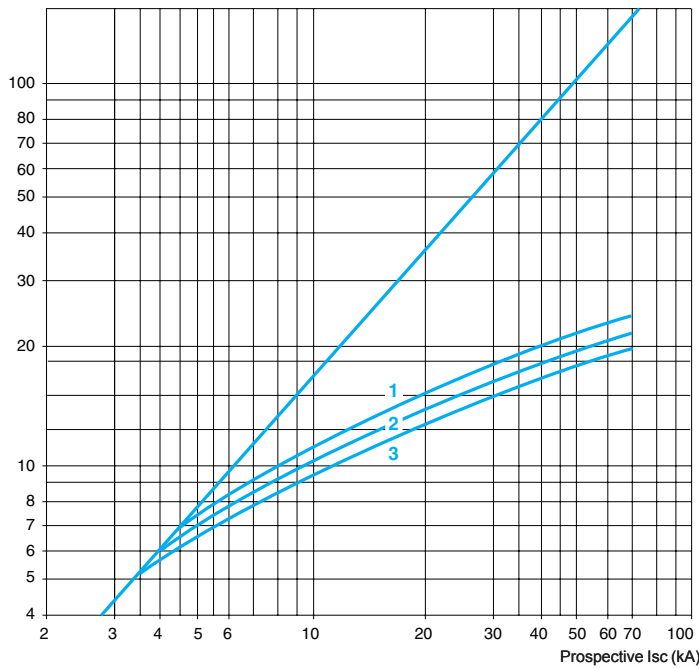

- 1 GV7 RE220
- 2 GV7 RE150
- 3 GV7 RE100

##### For GV7 RS only

Limited peak current (kA)

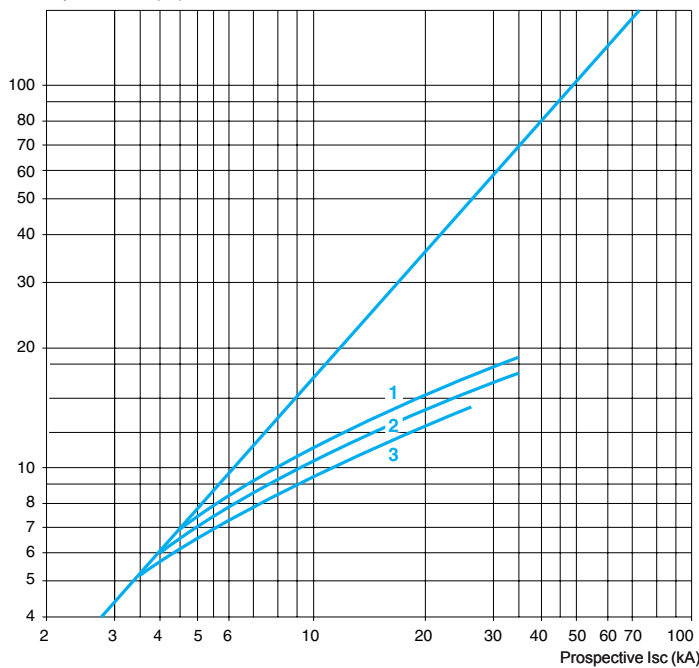

- 1 GV7 RS220
- 2 GV7 RS150
- 3 GV7 RS100



#### Thermal limit (3-phase 400/415 V)

##### Thermal limit

Sum of  $I^2dt = f$  (prospective  $I_{sc}$ )

##### For GV7 RE only

Sum of  $I^2dt$  (A<sup>2</sup>s)

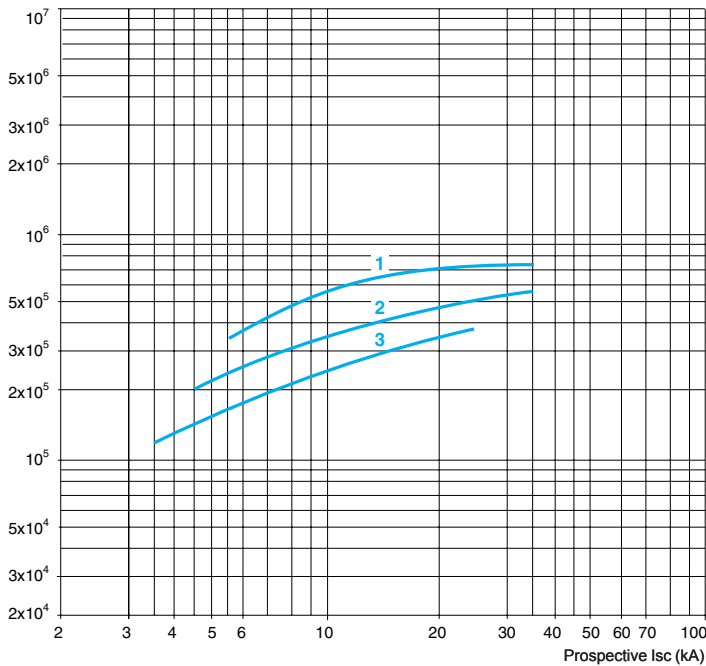

- 1 GV7 RE220
- 2 GV7 RE150
- 3 GV7 RE100

##### For GV7 RS only

Sum of  $I^2dt$  (A<sup>2</sup>s)

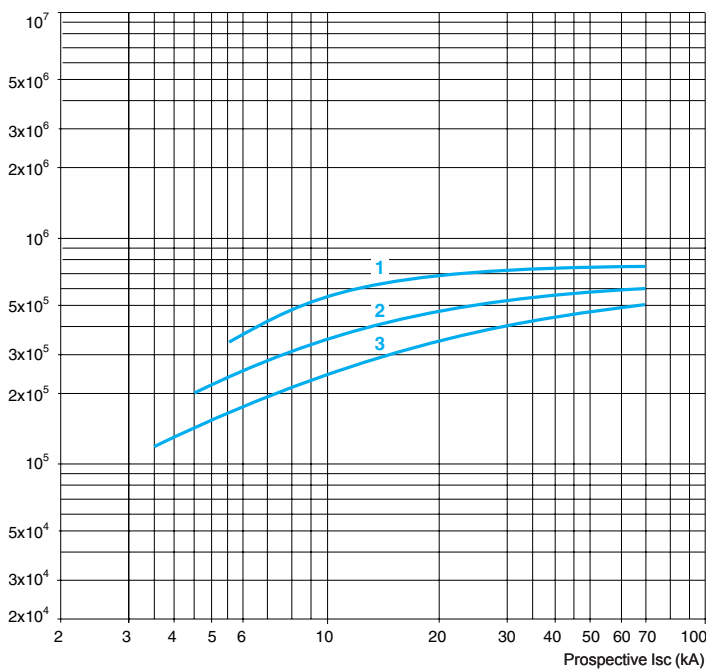

- 1 GV7 RS220
- 2 GV7 RS150
- 3 GV7 RS100

#### Current limitation on short-circuit (3-phase 690 V)

##### Dynamic stress

$I_{peak} = f(\text{prospective } I_{sc})$

##### For GV7 RE only

Limited peak current (kA)

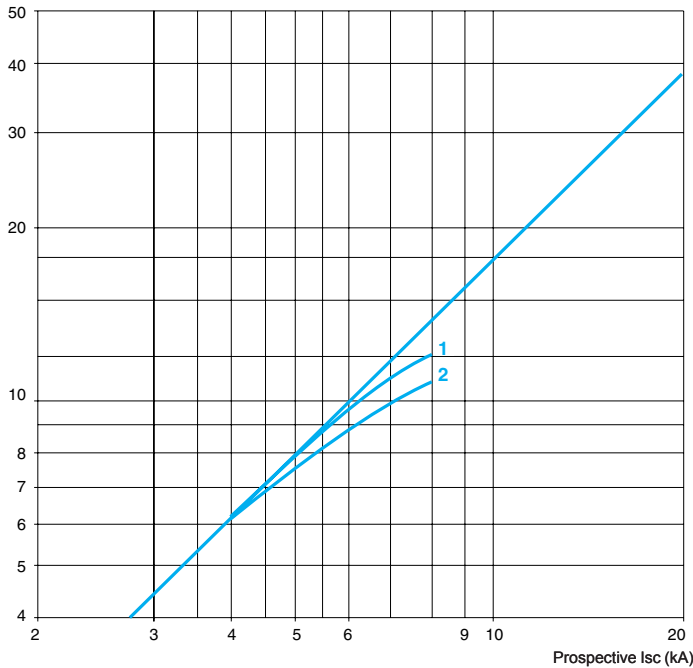

- 1 GV7 RE220
- 2 GV7 RE150 and GV7 RE100

##### For GV7 RS only

Limited peak current (kA)

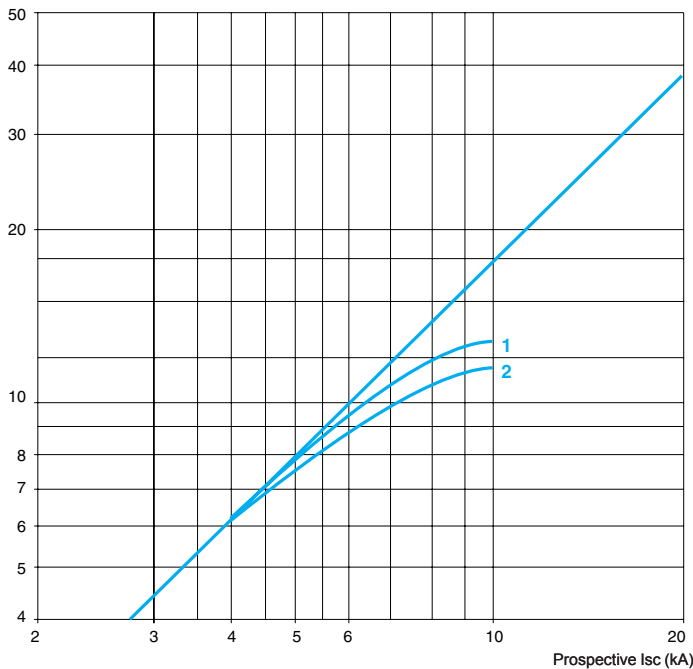

- 1 GV7 RS220
- 2 GV7 RS150 and GV7 RS100

#### Thermal limit on short-circuit (3-phase 690 V)

##### Thermal limit

Sum of  $I^2dt = f$  (prospective  $I_{sc}$ )

##### For GV7 RE only

Sum of  $I^2dt$  (A<sup>2</sup>s)

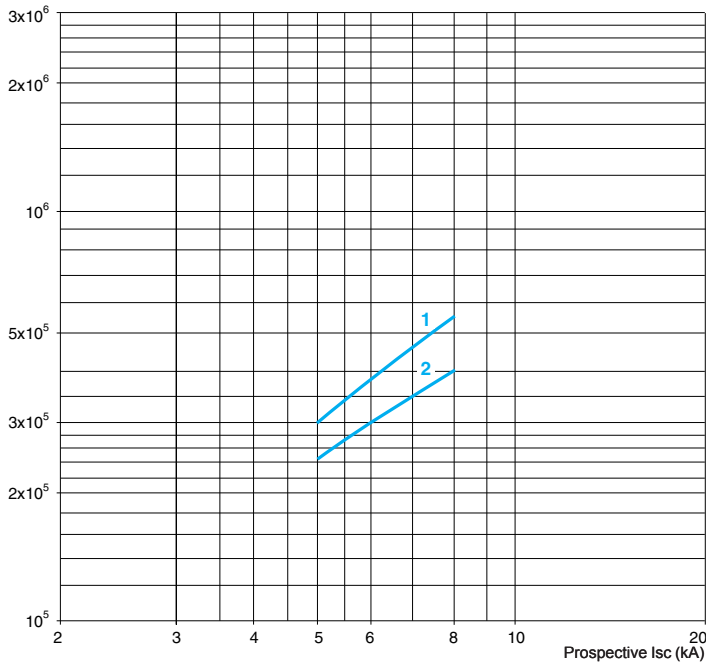

- 1 GV7 RE220
- 2 GV7 RE150 and GV7 RE100

##### For GV7 RS only

Sum of  $I^2dt$  (A<sup>2</sup>s)

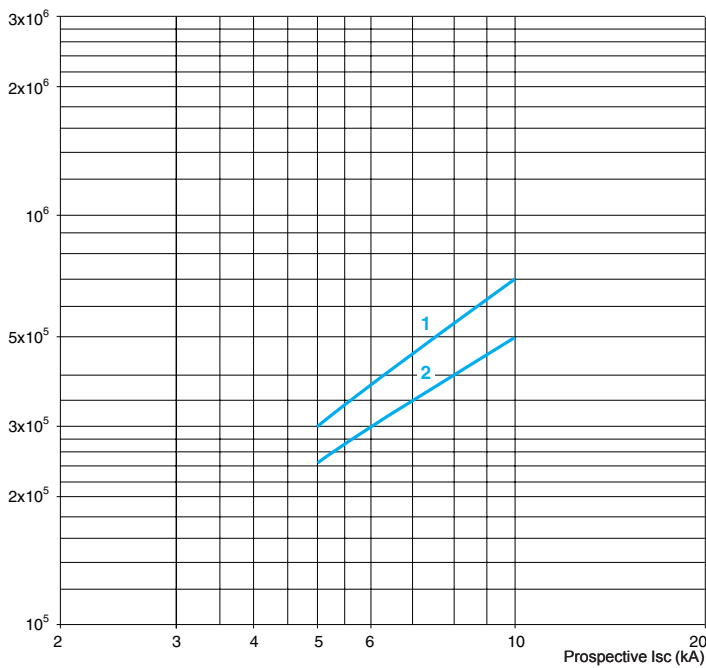

- 1 GV7 RS220
- 2 GV7 RS150 and GV7 RS100

**Thermal-magnetic tripping curves for GV2 RT**

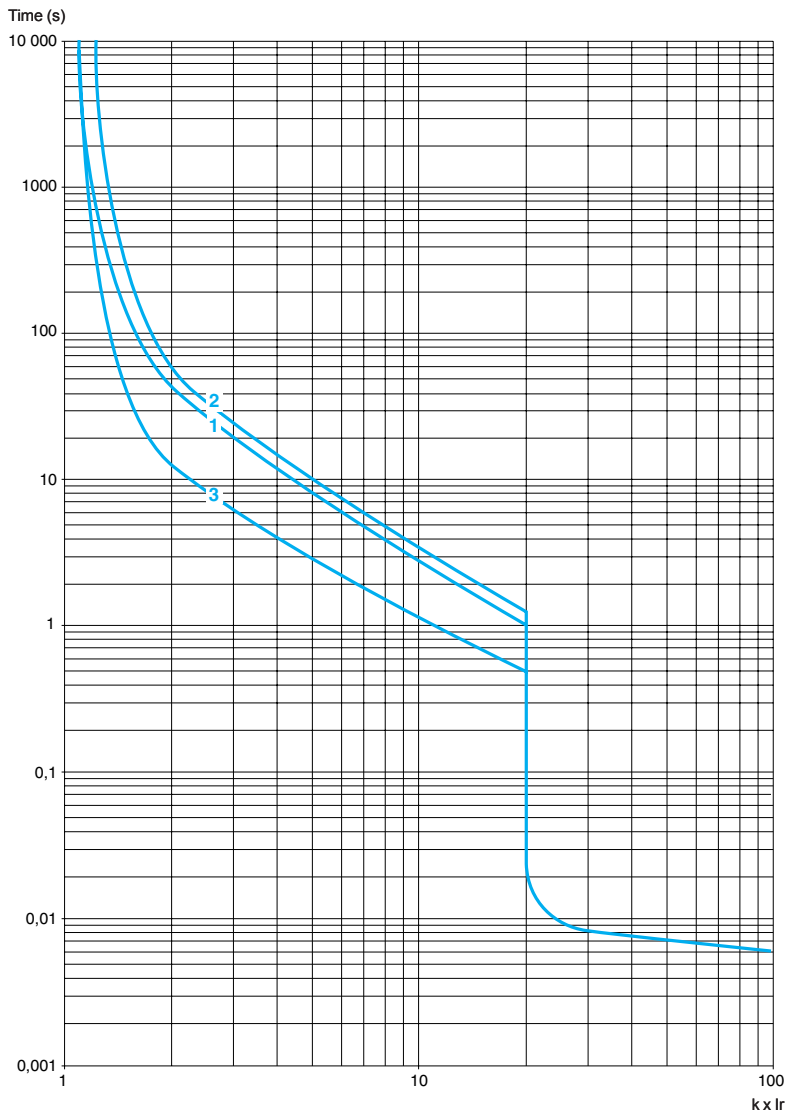

- 1** 3 poles from cold state
- 2** 2 poles from cold state
- 3** 3 poles from hot state

## Tripping curves for GV2 L or LE combined with thermal overload relay LRD or LR2 K

Average operating times at 20 °C related to multiples of the setting current

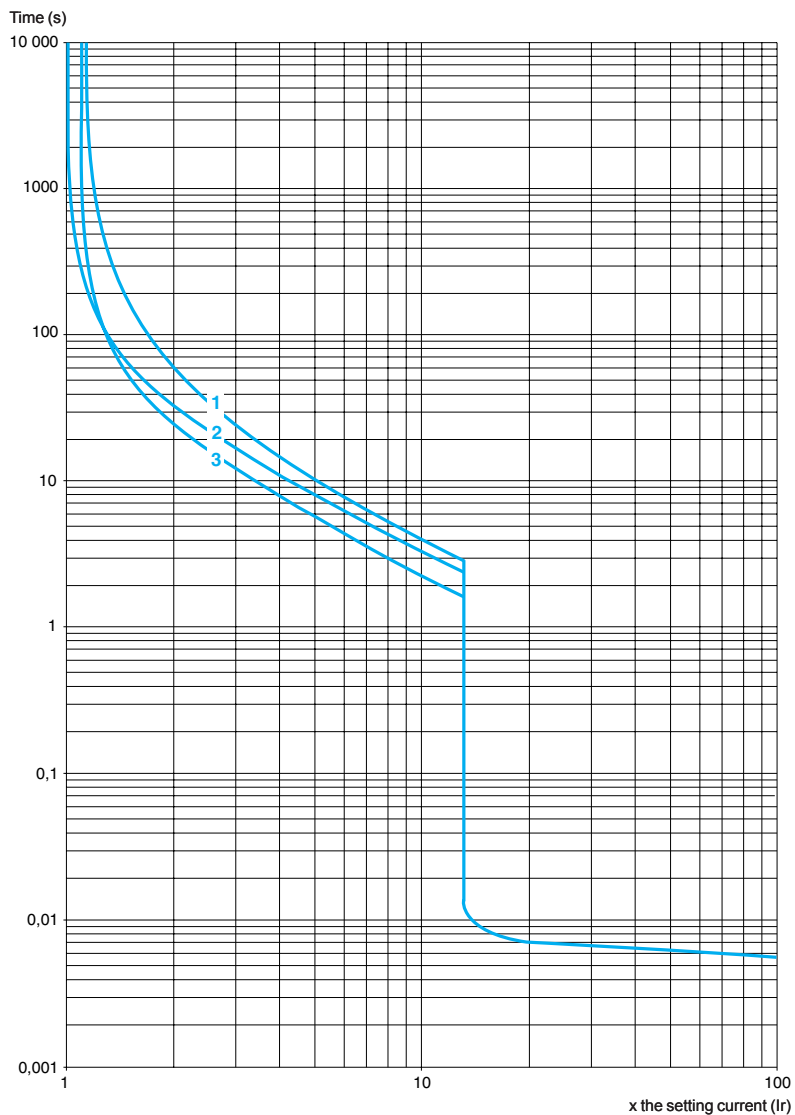

- 1 3 poles from cold state
- 2 2 poles from cold state
- 3 3 poles from hot state

**Current limitation on short-circuit for GV2 L and GV2 LE only (3-phase 400/415 V)**

**Dynamic stress**

$I_{peak} = f(\text{prospective } I_{sc}) \text{ at } 1.05 U_e = 435 \text{ V}$

Limited peak current (kA)

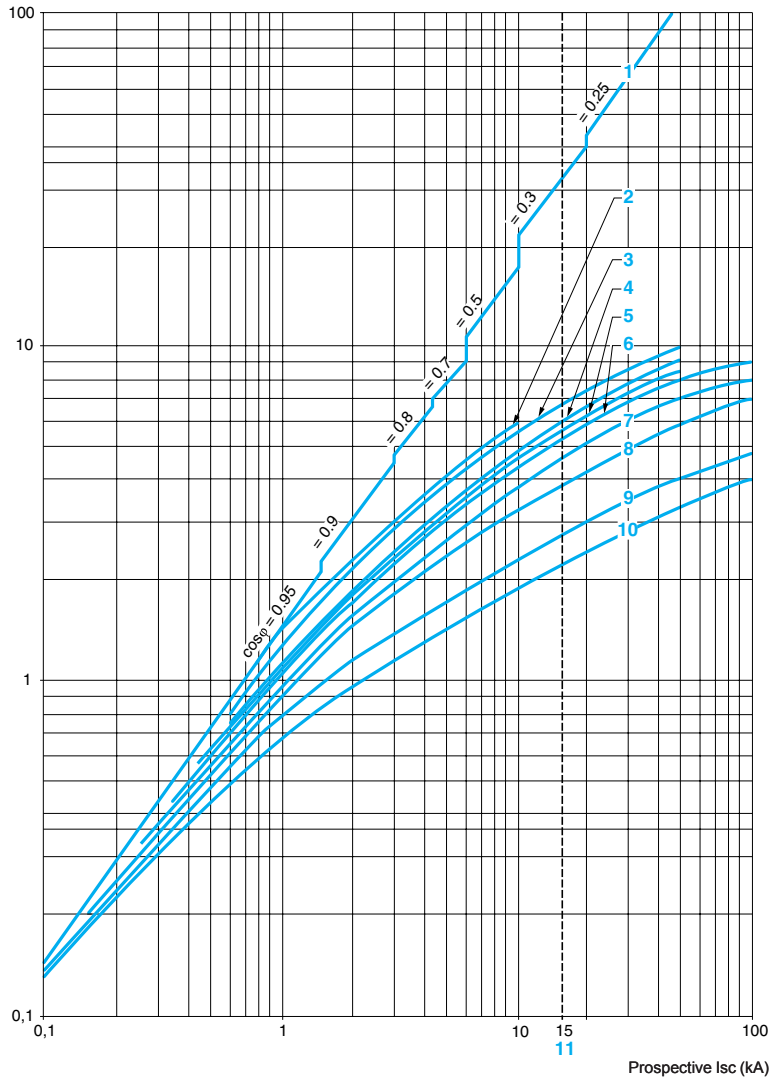

1 Maximum peak current

2 32 A

3 25 A

4 18 A

5 14 A

6 10 A

7 6.3 A

8 4 A

9 2.5 A

10 1.6 A

11 Limit of rated ultimate breaking capacity on short-circuit of GV2 LE (14, 18, 23 and 25 A ratings).

**Current limitation on short-circuit for GV2 L and GV2 LE + thermal overload relay LRD or LR2 K (3-phase 400/415 V)**  
Dynamic stress

$I_{peak} = f(\text{prospective } I_{sc}) \text{ at } 1.05 U_e = 435 \text{ V}$

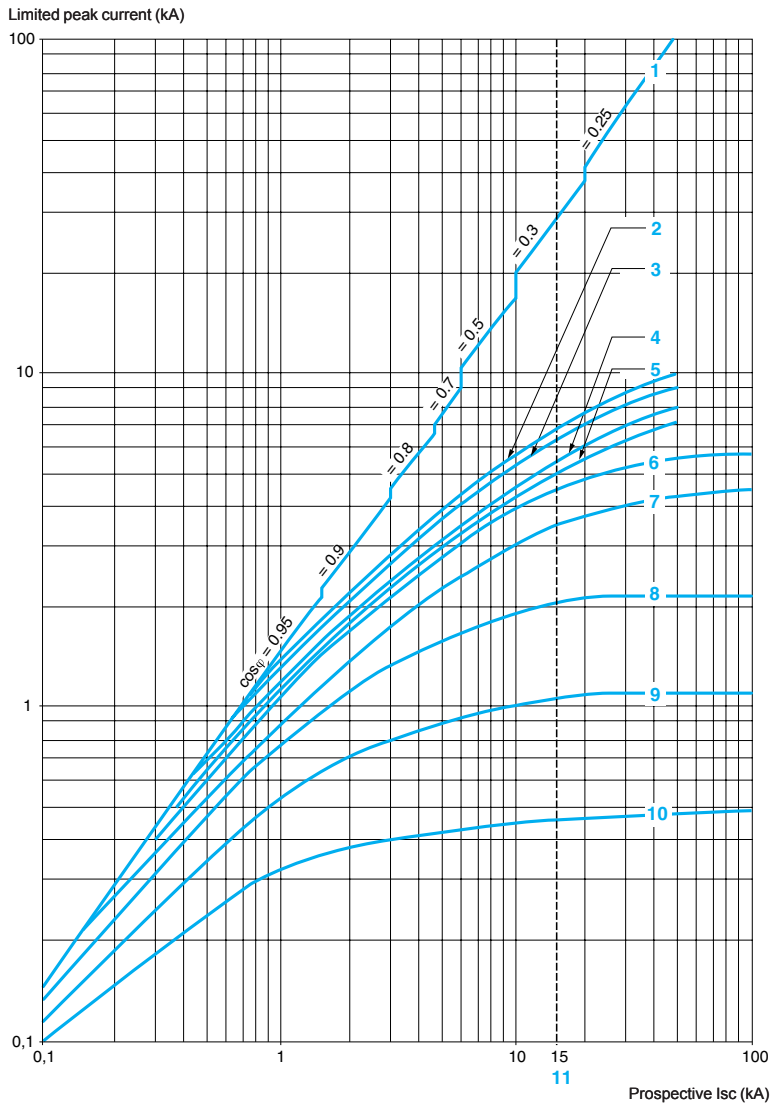

- 1 Maximum peak current
- 2 32 A
- 3 25 A
- 4 18 A
- 5 14 A
- 6 10 A
- 7 6.3 A
- 8 4 A
- 9 2.5 A
- 10 1.6 A
- 11 Limit of rated ultimate breaking capacity on short-circuit of GV2 LE (14, 18, 23 and 25 A ratings).

#### Thermal limit on short-circuit for GV2 LE only

Thermal limit in kA<sup>2</sup>s in the magnetic operating zone

Sum of I<sup>2</sup>dt = f (prospective I<sub>sc</sub>) at 1.05 U<sub>e</sub> = 435 V

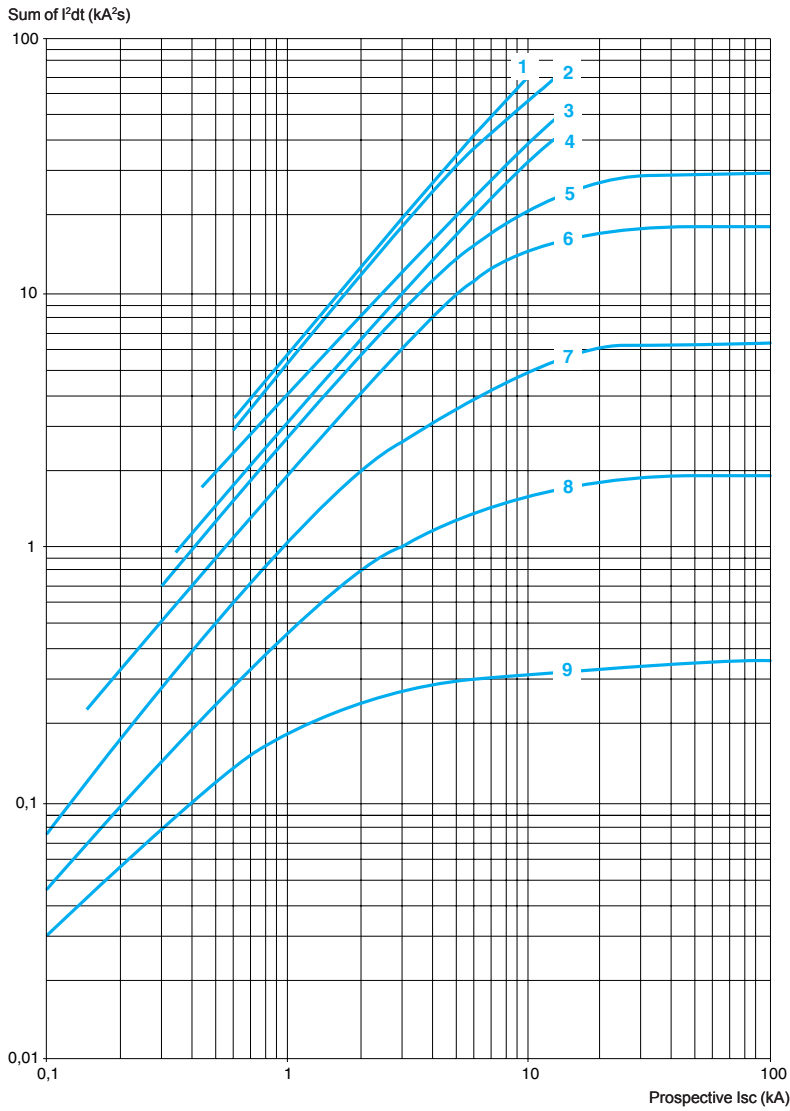

- 1 32 A
- 2 25 A
- 3 18 A
- 4 14 A
- 5 10 A
- 6 6.3 A
- 7 4 A
- 8 2.5 A
- 9 1.6 A



#### Thermal limit on short-circuit for GV2 L only

Thermal limit in  $kA^2s$  in the magnetic operating zone

Sum of  $I^2dt = f$  (prospective  $I_{sc}$ ) at  $1.05 U_e = 435 V$

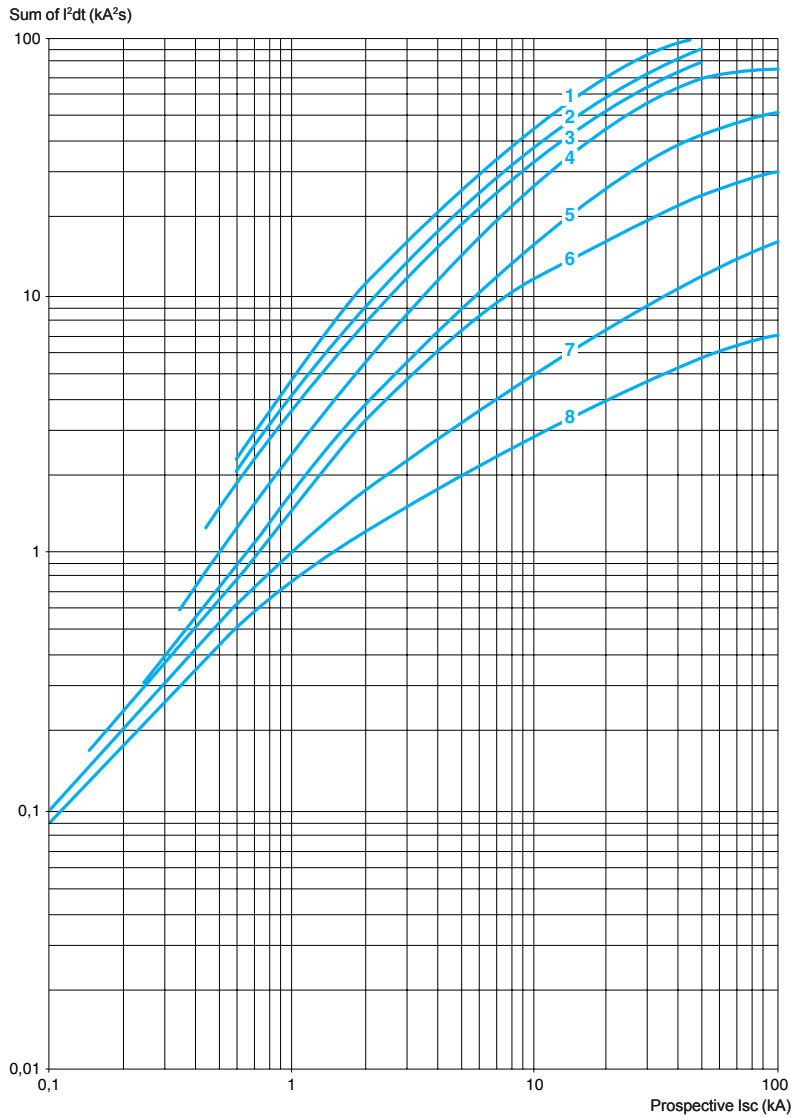

- 1 25 A and 32 A
- 2 18 A
- 3 14 A
- 4 10 A
- 5 6.3 A
- 6 4 A
- 7 2.5 A
- 8 1.6 A

#### Thermal limit on short-circuit for GV2 L and GV2 LE + thermal overload relay LRD or LR2K

Thermal limit in  $\text{kA}^2\text{s}$  in the magnetic operating zone

Sum of  $I^2dt = f$  (prospective  $I_{sc}$ ) at  $1.05 U_e = 435 \text{ V}$

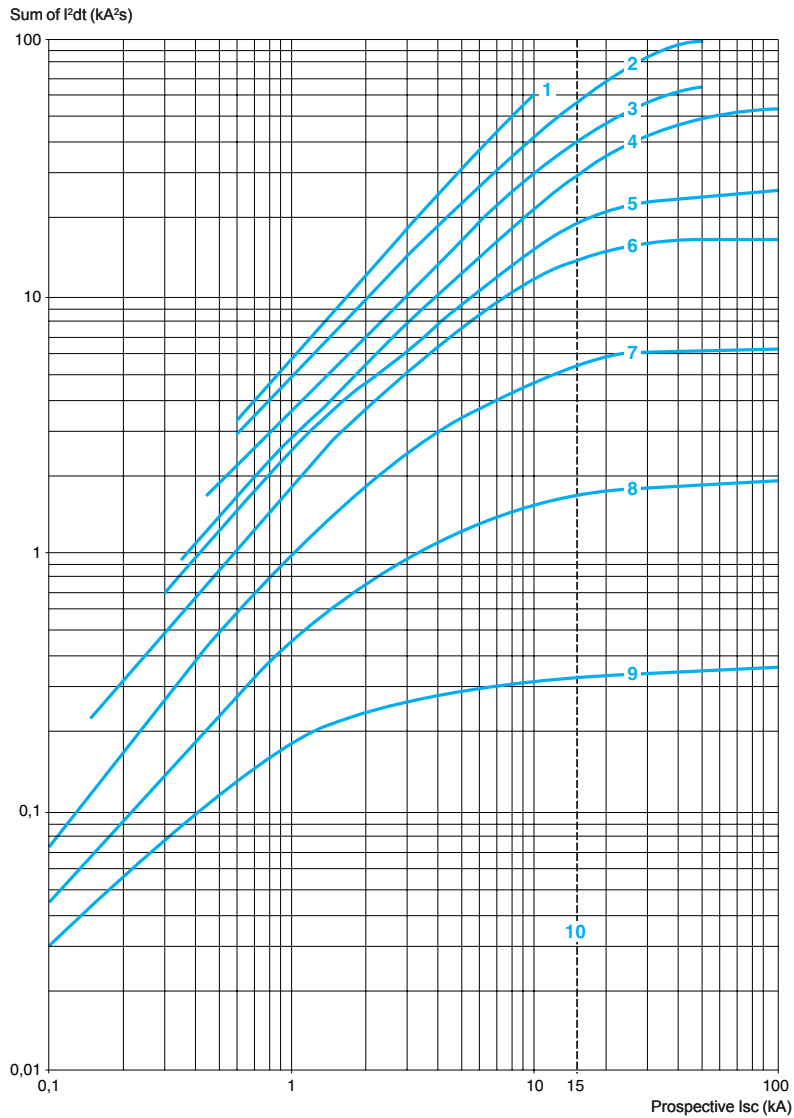

- 1 32 A (GV2 LE32)
- 2 25 A and 32 A (GV2 L32)
- 3 18 A
- 4 14 A
- 5 10 A
- 6 6.3 A
- 7 4 A
- 8 2.5 A
- 9 1.6 A
- 10 Limit of rated ultimate breaking capacity on short-circuit of GV2 LE (14, 18, 23 and 25 A ratings).

### Tripping curves for GV3 L and GK3 EF80 combined with thermal overload relay LRD 33

Average operating time at 20 °C without prior current flow

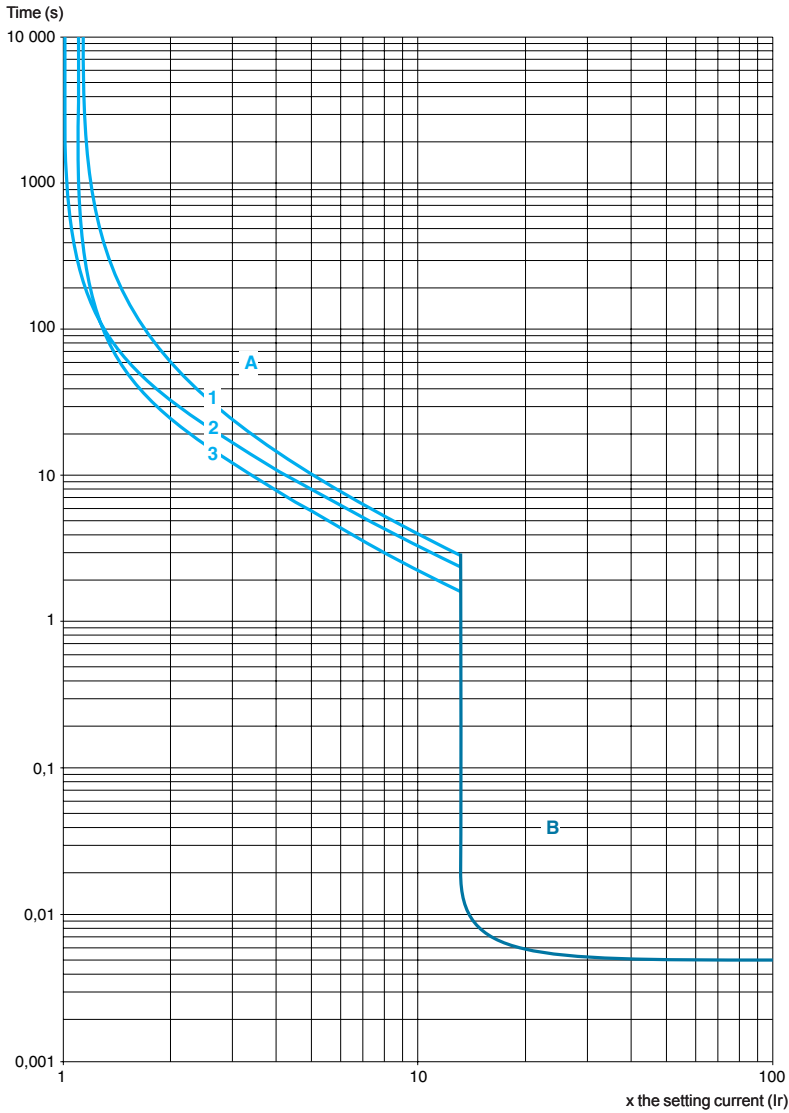

- 1 3 poles from cold state
- 2 2 poles from cold state
- 3 3 poles from hot state

- A Thermal overload relay protection zone
- B GK3 EF80 and GV3 protection zone L

**Current limitation on short-circuit for GV3 L and GK3 EF80 (3-phase 400/415 V)**

**Dynamic stress**

$I_{peak} = f(\text{prospective } I_{sc}) \text{ at } 1.05 U_e = 435 \text{ V}$

Limited peak current (kA)

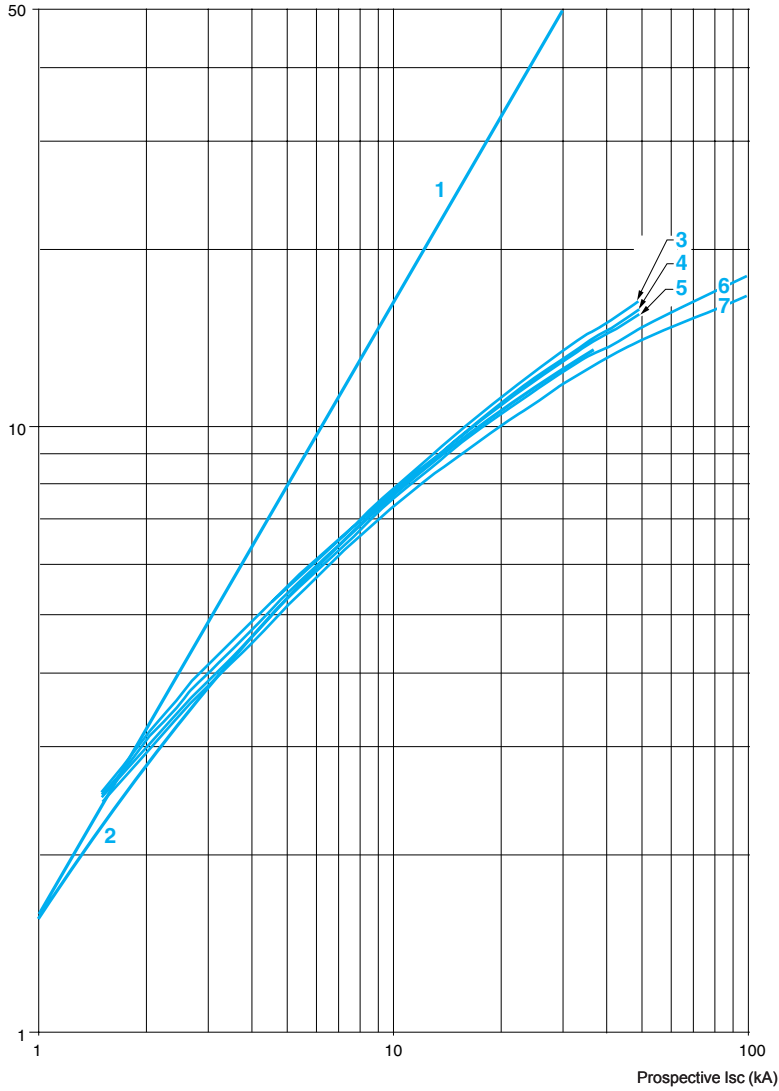

- 1 Maximum peak current
- 2 GK3 EF80
- 3 GV3 L65
- 4 GV3 L50
- 5 GV3 L40
- 6 GV3 L32
- 7 GV3 L25

### Thermal limit on short-circuit for GV3 L and GK3 EF80

Thermal limit in A<sup>2</sup>s

Sum of I<sup>2</sup>dt = f (prospective I<sub>sc</sub>) at 1.05 U<sub>e</sub> = 435 V

Sum of I<sup>2</sup>dt (A<sup>2</sup>s)

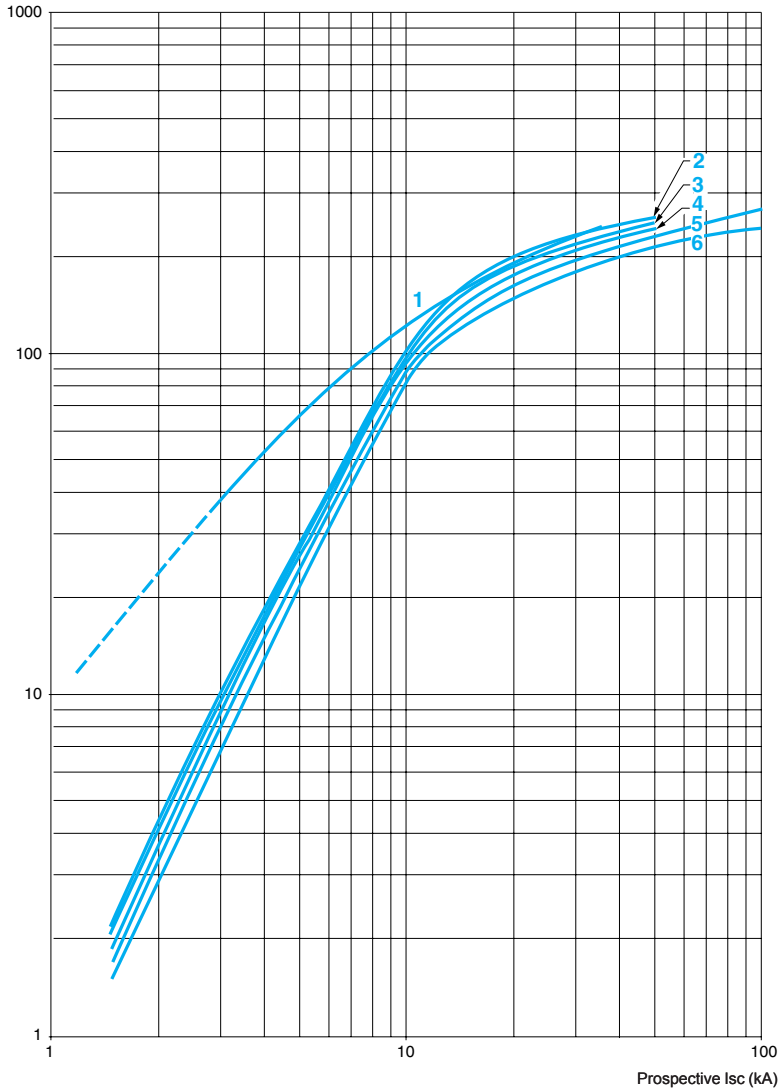

- 1 GK3 EF80
- 2 GV3 L65
- 3 GV3 L50
- 4 GV3 L40
- 5 GV3 L32
- 6 GV3 L25

# TeSys protection components

## Thermal-magnetic motor circuit-breakers

### GV2 ME

53986



GV2 ME10

#### Motor circuit-breakers from 0.06 to 15 kW / 400 V, with screw clamp terminals

##### GV2 ME with pushbutton control

Standard power ratings of 3-phase motors  
50-60 Hz in category AC-3

400/415 V			500 V			690 V			Setting range of thermal trips (2)	Magnetic tripping current Id ± 20 %	Reference	Weight
P	Icu	Ics (1)	P	Icu	Ics (1)	P	Icu	Ics (1)				
kW	kA	%	kW	kA	%	kW	kA	%	A	A	kg	
–	–	–	–	–	–	–	–	–	0.1...0.16	1.5	GV2 ME01	0.260
0.06	*	*	–	–	–	–	–	–	0.16...0.25	2.4	GV2 ME02	0.260
0.09	*	*	–	–	–	–	–	–	0.25...0.40	5	GV2 ME03	0.260
0.12	*	*	–	–	–	0.37	*	*	0.40...0.63	8	GV2 ME04	0.260
0.18	*	*	–	–	–	–	–	–				
0.25	*	*	–	–	–	0.55	*	*	0.63...1	13	GV2 ME05	0.260
0.37	*	*	0.37	*	*	–	–	–	1...16	22.5	GV2 ME06	0.260
0.55	*	*	0.55	*	*	0.75	*	*				
–	–	–	0.75	*	*	1.1	*	*				
0.75	*	*	1.1	*	*	1.5	3	75	1.6...2.5	33.5	GV2 ME07	0.260
1.1	*	*	1.5	*	*	2.2	3	75	2.5...4	51	GV2 ME08	0.260
1.5	*	*	2.2	*	*	3	3	75				
2.2	*	*	3	50	100	4	3	75	4...6.3	78	GV2 ME10	0.260
3	*	*	4	10	100	5.5	3	75	6...10	138	GV2 ME14	0.260
4	*	*	5.5	10	100	7.5	3	75				
5.5	15	50	7.5	6	75	9	3	75	9...14	170	GV2 ME16	0.260
–	–	–	–	–	–	11	3	75				
7.5	15	50	9	6	75	15	3	75	13...18	223	GV2 ME20	0.260
9	15	40	11	4	75	18.5	3	75	17...23	327	GV2 ME21	0.260
11	15	40	15	4	75	–	–	–	20...25	327	GV2 ME22 (3)	0.260
15	10	50	18.5	4	75	22	3	75	24...32	416	GV2 ME32	0.260

#### Motor circuit-breakers from 0.06 to 15 kW / 400 V, with lugs

To order thermal magnetic circuit-breakers with connection by lugs, add the digit **6** to the end of reference selected above.

Example: **GV2 ME08** becomes **GV2 ME086**.

#### Thermal magnetic circuit-breakers GV2 ME with built-in auxiliary contact block

With instantaneous auxiliary contact block (composition, see page 87):

- GV AE1, add suffix **AE1TQ** to the motor circuit-breaker reference selected above.  
Example: **GV2 ME01AE1TQ**.
- GV AE11, add suffix **AE11TQ** to the motor circuit-breaker reference selected above.  
Example: **GV2 ME01AE11TQ**.
- GV AN11, add suffix **AN11TQ** to the motor circuit-breaker reference selected above.  
Example: **GV2 ME01AN11TQ**.

These circuit-breakers with built-in contact block are sold in lots of 20 units in a single pack.

(1) As % of Icu.

(2) The thermal trip setting must be within the range marked on the graduated knob.

(3) Maximum rating which can be mounted in enclosures **GV2 MC** or **MP**, please consult your Regional Sales Office.

\* > 100 kA.

553897



GV2 ME●●3

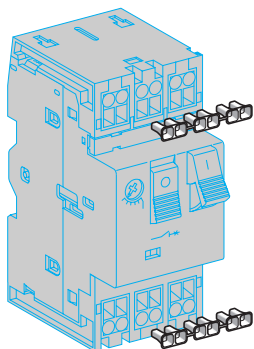

LA9 D99

#### Motor circuit-breakers from 0.06 to 11 kW, with spring terminal connections

##### GV2 ME (1) with pushbutton control

Standard power ratings of 3-phase motors 50-60 Hz in category AC-3						Setting range of thermal trips (3)	Magnetic tripping current I <sub>d</sub> ± 20 %	Reference	Weight
400/415 V			500 V						
P	I <sub>cu</sub>	I <sub>cs</sub> (2)	P	I <sub>cu</sub>	I <sub>cs</sub> (2)				
kW	kA	%	kW	kA	%	A	A	kg	
–	–	–	–	–	–	0.1...0.16	1.5	GV2 ME013	0.280
0.06	*	*	–	–	–	0.16...0.25	2.4	GV2 ME023	0.280
0.09	*	*	–	–	–	0.25...0.40	5	GV2 ME033	0.280
0.12	*	*	–	–	–	0.40...0.63	8	GV2 ME043	0.280
0.18	*	*	–	–	–	0.63...1	13	GV2 ME053	0.280
0.25	*	*	0.37	*	*	1...1.6	22.5	GV2 ME063	0.280
0.37	*	*	0.55	*	*	1.6...2.5	33.5	GV2 ME073	0.280
0.55	*	*	0.75	*	*	2.5...4	51	GV2 ME083	0.280
0.75	*	*	1.1	*	*	4...6.3	78	GV2 ME103	0.280
1.1	*	*	1.5	*	*	6...10	138	GV2 ME143	0.280
1.5	*	*	2.2	*	*	10...15	170	GV2 ME163	0.280
2.2	*	*	3	50	100	15...20	223	GV2 ME203	0.280
3	*	*	4	10	100	20...25	327	GV2 ME213	0.260
4	*	*	5.5	10	100	25...32	327	GV2 ME223	0.260
5.5	15	50	7.5	6	75				
7.5	15	50	9	6	75				
9	15	40	11	4	75				
11	15	40	15	4	75				

#### Contact blocks

Description	Mounting	Maximum number	Type of contacts	Sold in lots of	Unit reference	Weight kg
Instantaneous auxiliary contacts	Front	1	N/O + N/C	10	GV AE113	0.030
			N/O + N/O	10	GV AE203	0.030
	LH side	2	N/O + N/C	1	GV AN113	0.060
			N/O + N/O	1	GV AN203	0.060

#### Accessory

Description	Application	Sold in lots of	Unit reference	Weight kg
Cable end reducer	For connection of conductors from 1 to 1.5 mm <sup>2</sup>	20	LA9 D99	–

(1) For connection of conductors from 1 to 1.5 mm<sup>2</sup>, the use of an LA9 D99 cable end reducer is recommended.

(2) Maximum rating which can be mounted in enclosures GV2 MC or MP, please consult your Regional Sales Office

(3) The thermal trip setting must be within the range marked on the graduated knob.

\* > 100 kA.

# TeSys protection components

## Thermal-magnetic motor circuit-breakers

### GV2 P, GV3 P and GV3 ME80



GV2 P10



GV3 P65

#### Motor circuit-breakers from 0.06 to 30 kW / 400 V

Standard power ratings of 3-phase motors  
50/60 Hz in category AC-3

400/415 V			500 V			690 V			Setting range of thermal trips	Magnetic tripping current I <sub>d</sub> ± 20 %	Reference	Weight
P	I <sub>cu</sub>	I <sub>cs</sub>	P	I <sub>cu</sub>	I <sub>cs</sub>	P	I <sub>cu</sub>	I <sub>cs</sub>				
kW	kA	%	kW	kA	%	kW	kA	%	A	A		kg

#### GV2 P: control by rotary knob

Screw clamp terminals

–	–	–	–	–	–	–	–	–	0.1...0.16	1.5	GV2 P01	0.350
0.06	*	*	–	–	–	–	–	–	0.16...0.25	2.4	GV2 P02	0.350
0.09	*	*	–	–	–	–	–	–	0.25...0.40	5	GV2 P03	0.350
0.12	*	*	–	–	–	0.37	*	*	0.40...0.63	8	GV2 P04	0.350
0.18	*	*	–	–	–	–	–	–	–	–	–	–
0.25	*	*	–	–	–	0.55	*	*	0.63...1	13	GV2 P05	0.350
0.37	*	*	0.37	*	*	–	–	–	1...1.6	22.5	GV2 P06	0.350
0.55	*	*	0.55	*	*	0.75	*	*	–	–	–	–
0.75	*	*	1.1	*	*	1.5	8	100	1.6...2.5	33.5	GV2 P07	0.350
1.1	*	*	1.5	*	*	2.2	8	100	2.5...4	51	GV2 P08	0.350
2.2	*	*	3	*	*	4	6	100	4...6.3	78	GV2 P10	0.350
3	*	*	5	50	100	5.5	6	100	6...10	138	GV2 P14	0.350
5.5	*	*	7.5	42	75	9	6	100	9...14	170	GV2 P16	0.350
–	–	–	–	–	–	11	6	100	–	–	–	–
7.5	50	50	9	10	75	15	4	100	13...18	223	GV2 P20	0.350
9	50	50	11	10	75	18.5	4	100	17...23	327	GV2 P21	0.350
11	50	50	15	10	75	–	–	–	20...25	327	GV2 P22	0.350
15	35	50	18.5	10	75	22	4	100	24...32	416	GV2 P32	0.350

#### GV3 P: control by rotary knob

Connection by EverLink® BTR screw connectors (3)

5.5	100	50	7.5	12	50	11	6	50	9...13	182	GV3 P13	1.000
7.5	100	50	9	12	50	15	6	50	12...18	252	GV3 P18	1.000
11	100	50	15	12	50	18.5	6	50	17...25	350	GV3 P25	1.000
15	100	50	18.5	12	50	22	6	50	23...32	448	GV3 P32	1.000
18.5	50	50	22	10	50	37	5	60	30...40	560	GV3 P40	1.000
22	50	50	30	10	50	45	5	60	37...50	700	GV3 P50	1.000
30	50	50	45	10	50	55	5	60	48...65	910	GV3 P65	1.000

#### Connection by lugs

To order thermal magnetic circuit-breakers with connection by lugs, add the digit **6** to the end of reference selected above. Example: **GV3 P18** becomes **GV3 P186**.

#### GV3 ME80: pushbutton control, screw clamp terminals

37	15	50	45	4	100	55	2	100	56...80		GV3 ME80 (4)	0.700
----	----	----	----	---	-----	----	---	-----	---------	--	--------------	-------

#### Motor circuit-breakers up to 50 hp / 600 V, UL 508 type E

##### GV2 (5)

To obtain a GV2 P motor circuit-breaker, UL 508 type E, combine :

- a circuit-breaker **GV2 P●●H7** (except 32 A),
- and a "Large Spacing" adapter **GV2 GH7**.

##### GV3 (6)

To obtain a motor-circuit-breaker GV3 P, UL 508 type E, use the following with the circuit-breaker:

- a "Large Spacing" cover **GV3 G66**,
- a short-circuit signalling contact **GV AM11**.

##### GV3 with connection by lugs (6)

To obtain a motor-circuit-breaker GV3 P, UL 508 type E, with connection by lugs, add the digit **6** to the end of reference selected above and use the following with the circuit-breaker :

- two IP 20 covers **LAD 96570**,
- a short-circuit signalling contact **GV AM11**.

(1) As % of I<sub>cu</sub>.

(2) The thermal trip setting must be within the range marked on the graduated knob.

(3) BTR screws: hexagon socket head. Require use of an insulated Allen key, in compliance with local wiring regulations.

(4) Recommended for use in association with a contactor.

(5) Accessory: see page 91.

(6) Accessories: see page 85.

\* > 100 kA.



# TeSys protection components

## Thermal-magnetic motor circuit-breakers

### GV7 R

553900



GV7 RE40

553901



GV7 RS220

#### Thermal-magnetic circuit-breakers GV7 R with screw clamp terminals

##### Control by rocker lever

Standard power ratings of 3-phase motors  
50/60 Hz in category AC-3

400/415 V			500 V			660/690 V			Setting range of thermal trips A	Reference	Weight kg
P	Icu	Ics (1)	P	Icu	Ics (1)	P	Icu	Ics (1)			
kW	kA	%	kW	kA	%	kW	kA	%			
7.5	36	100	9	18	100	11	8	100	12...20	GV7 RE20	2.010
9	36	100	11	18	100	15	8	100			
7.5	70	100	9	50	100	11	10	100	12...20	GV7 RS20	2.010
9	70	100	11	50	100	15	10	100			
9	36	100	11	18	100	15	8	100	15...25	GV7 RE25	2.010
11	36	100	15	18	100	18.5	8	100			
9	70	100	11	50	100	15	10	100	15...25	GV7 RS25	2.010
11	70	100	15	50	100	18.5	10	100			
18.5	36	100	18.5	18	100	22	8	100	25...40	GV7 RE40	2.010
			22	18	100						
18.5	70	100	18.5	50	100	22	10	100	25...40	GV7 RS40	2.010
22	36	100	30	18	100	30	8	100	30...50	GV7 RE50	2.015
22	70	100	30	50	100	30	10	100	30...50	GV7 RS50	2.015
37	36	100	45	18	100	55	8	100	48...80	GV7 RE80	2.040
			55	18	100						
37	70	100	45	50	100	55	10	100	48...80	GV7 RS80	2.040
			55	50	100						
45	36	100	–	18	100	75	8	100	60...100	GV7 RE100	2.040
45	70	100	–	50	100	75	10	100	60...100	GV7 RS100	2.040
55	35	100	75	30	100	90	8	100	90...150	GV7 RE150	2.020
75	35	100	90	30	100	110	8	100			
55	70	100	75	50	100	90	10	100	90...150	GV7 RS150	2.020
75	70	100	90	50	100	110	10	100			
90	35	100	110	30	100	160	8	100	132...220	GV7 RE220	2.350
110	35	100	132	30	100	200	8	100			
			160	30	100						
90	70	100	110	50	100	160	10	100	132...220	GV7 RS220	2.350
110	70	100	132	50	100	200	10	100			
			160	50	100						

(1) As % of Icu.

# TeSys protection components

## Thermal-magnetic circuit-breakers

### GV2 RT

510570



GV2 RT

#### For motors with high current peak on starting

##### Control by rocker lever

Standard power ratings of 3-phase motors 50-60 Hz in category AC-3					Setting range of thermal trips (1)	Magnetic tripping current I <sub>d</sub> ± 20 %	Reference	Weight
220/ 230 V	400/ 415 V	440 V	500 V	690 V				
kW	kW	kW	kW	kW	A	A		kg
0.06	0.09	0.09 0.12	–	–	0.25...0.40	8	<b>GV2 RT03</b>	0.350
–	0.12 0.18	0.18	–	0.37	0.40...0.63	13	<b>GV2 RT04</b>	0.350
0.09 0.12	0.25 0.37	0.25 0.37	0.37	0.55	0.63...1	22	<b>GV2 RT05</b>	0.350
0.18 0.25	0.37 0.55	0.37 0.55	0.37 0.55 0.75	0.75 1.1	1...1.6	33	<b>GV2 RT06</b>	0.350
0.37	0.75	0.75 1.1	1.1	1.5	1.6...2.5	51	<b>GV2 RT07</b>	0.350
0.55 0.75	1.1 1.5	1.5	1.5 2.2	2.2 3	2.5...4	78	<b>GV2 RT08</b>	0.350
1.1	2.2	2.2 3	3	4	4...6.3	138	<b>GV2 RT10</b>	0.350
1.5 2.2	3 4	4	4 5.5	5.5 7.5	6...10	200	<b>GV2 RT14</b>	0.350
2.2 3	5.5	5.5 7.5	7.5	9 11	9...14	280	<b>GV2 RT16</b>	0.350
4	7.5	7.5 9	9	15	13...18	400	<b>GV2 RT20</b>	0.350
5.5	9 11	11	11	18.5	17...23	400	<b>GV2 RT21</b>	0.350

(1) The thermal trip setting must be within the range marked on the graduated knob.

# TeSys protection components

## Thermal-magnetic circuit-breakers

### GV2 RT



GV2 RT

#### For primaries of 3-phase transformers

##### Control by rocker lever

Standard power ratings					Setting range of thermal trips (1)	Magnetic tripping current $I_d \pm 20\%$	Reference	Weight
230/240 V	400/415 V	440 V	500 V	690 V				
kW	kW	kW	kW	kW	A	A		kg
–	–	–	–	–	0.25...0.40	8	GV2 RT03	0.350
–	–	–	–	–	0.40...0.63	13	GV2 RT04	0.350
–	–	0.63	0.63	1	0.63...1	22	GV2 RT05	0.350
0.4	0.63	1	1	–	1...1.6	33	GV2 RT06	0.350
0.63	1	–	1.6	1.6 2	1.6...2.5	51	GV2 RT07	0.350
1	1.6 2	1.6 2	2 2.5	2.5	2.5...4	78	GV2 RT08	0.350
1.6 2	2.5	2.5 4	4	4 5 6.3	4...6.3	138	GV2 RT10	0.350
2.5	4 5	5	5 6.3	–	6...10	200	GV2 RT14	0.350
4	6.3	6.3	–	10 12.5	9...14	280	GV2 RT16	0.350
5 6.3	10	10	10 12.5	10	13...18	400	GV2 RT20	0.350

#### Accessory (2)

Description	Reference	Weight kg
Padlockable external operator (IP 54) black handle, blue legend plate	GV2 AP03	0.280

(1) The thermal trip setting must be within the range marked on the graduated knob.

(2) Other accessories such as mounting, cabling and marking accessories are identical to those used for GV2 ME motor circuit-breakers, see page 91.

# TeSys protection components

## Magnetic motor circuit-breakers

### GV2 LE

534101



GV2 LE10

Magnetic motor circuit-breakers from 0.06 to 15 kW													
GV2 L: control by rocker lever, connection by screw clamp terminals													
Standard power ratings of 3-phase motors 50/60 Hz in category AC-3									Magnetic protection rating	Tripping current I <sub>d</sub> ± 20 %	Use in association with thermal overload relay	Reference	Weight
400/415 V			500 V			690 V							
P	I <sub>cu</sub>	I <sub>cs</sub> (1)	P	I <sub>cu</sub>	I <sub>cs</sub> (1)	P	I <sub>cu</sub>	I <sub>cs</sub> (1)	A	A			kg
0.06	*	*	-	-	-	-	-	-	0.4	5	LR2 K0302	GV2 LE03	0.330
0.09	*	*	-	-	-	-	-	-	0.4	5	LR2 K0304	GV2 LE03	0.330
0.12	*	*	-	-	-	0.37	*	*	0.63	8	LR2 K0304	GV2 LE04	0.330
0.18	*	*	-	-	-	-	-	-	0.63	8	LR2 K0305	GV2 LE04	0.330
-	-	-	-	-	-	0.55	*	*	1	13	LR2 K0305	GV2 LE05	0.330
0.25	*	*	-	-	-	-	-	-	1	13	LR2 K0306	GV2 LE05	0.330
-	-	-	-	-	-	0.75	*	*	1	13	LR2 K0306	GV2 LE05	0.330
0.37	*	*	0.37	*	*	-	-	-	1	13	LR2 K0306	GV2 LE05	0.330
0.55	*	*	0.55	*	*	1.1	*	*	1.6	22.5	LR2 K0307	GV2 LE06	0.330
-	-	-	0.75	*	*	-	-	-	1.6	22.5	LR2 K0307	GV2 LE06	0.330
0.75	*	*	1.1	*	*	1.5	3	75	2.5	33.5	LR2 K0308	GV2 LE07	0.330
1.1	*	*	-	-	-	-	-	-	2.5	33.5	LR2 K0308	GV2 LE07	0.330
1.5	*	*	1.5	*	*	3	3	75	4	51	LR2 K0310	GV2 LE08	0.330
-	-	-	2.2	*	*	-	-	-	4	51	LR2 K0312	GV2 LE08	0.330
2.2	*	*	3	50	100	4	3	75	6.3	78	LR2 K0312	GV2 LE10	0.330
3	*	*	4	10	100	5.5	3	75	10	138	LR2 K0314	GV2 LE14	0.330
4	*	*	5.5	10	100	-	-	-	10	138	LR2 K0316	GV2 LE14	0.330
-	-	-	-	-	-	7.5	3	75	10	138	LRD 14	GV2 LE14	0.330
-	-	-	-	-	-	9	3	75	14	170	LRD 16	GV2 LE16	0.330
5.5	15	50	7.5	6	75	11	3	75	14	170	LR2 K0321	GV2 LE16	0.330
7.5	15	50	9	6	75	15	3	75	18	223	LRD 21	GV2 LE20	0.330
9	15	40	11	4	75	18.5	3	75	25	327	LRD 22	GV2 LE22	0.330
11	15	40	15	4	75	-	-	-	25	327	LRD 22	GV2 LE22	0.330
15	10	50	18.5	4	75	22	3	75	32	416	LRD 32	GV2 LE32	0.330

(1) As % of I<sub>cu</sub>.  
\* > 100 kA.

# TeSys protection components

## Magnetic motor circuit-breakers

### GV2 L, GV3 L and GK3 EF80

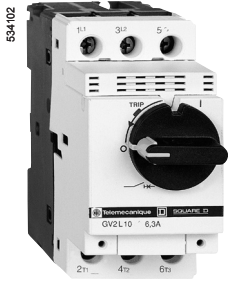

GV2 L10



GV3 L65



GK3 EF80

#### Motor circuit-breakers from 0.09 to 30 kW

##### GV2 L: Control by rotary knob, connection by screw clamp terminals

Standard power ratings of 3-phase motors 50/60 Hz in category AC-3									Magnetic protection rating	Tripping current Id ± 20 %	Use in association with thermal overload relay	Reference	Weight
400/415 V			500 V			690 V							
P	Icu	Ics (1)	P	Icu	Ics (1)	P	Icu	Ics (1)					
kW	kA		kW	kA		kW	kA		A	A			kg
0.09	★	★	-	-	-	-	-	-	0.4	5	LRD 03	GV2 L03	0.330
0.12	★	★	-	-	-	0.37	★	★	0.63	8	LRD 04	GV2 L04	0.330
0.18	★	★	-	-	-	-	-	-	0.63	8	LRD 04	GV2 L04	0.330
-	-	-	-	-	-	0.55	★	★	1	13	LRD 05	GV2 L05	0.330
0.25	★	★	-	-	-	-	-	-	1	13	LRD 05	GV2 L05	0.330
-	-	-	-	-	-	0.75	★	★	1	13	LRD 06	GV2 L05	0.330
0.37	★	★	0.37	★	★	-	-	-	1	13	LRD 05	GV2 L05	0.330
0.55	★	★	0.55	★	★	1.1	★	★	1.6	22.5	LRD 06	GV2 L06	0.330
-	-	-	0.75	★	★	-	-	-	1.6	22.5	LRD 06	GV2 L06	0.330
0.75	★	★	1.1	★	★	1.5	4	100	2.5	33.5	LRD 07	GV2 L07	0.330
1.1	-	-	-	-	-	-	-	-	-	-	LRD 08	GV2 L08	0.330
1.5	★	★	1.5	★	★	3	4	100	4	51	LRD 08	GV2 L08	0.330
-	-	-	-	-	-	-	-	-	-	-	LRD 08	GV2 L08	0.330
2.2	★	★	3	★	★	4	4	100	6.3	78	LRD 10	GV2 L10	0.330
3	★	★	4	10	100	5.5	4	100	10	138	LRD 12	GV2 L14	0.330
4	-	-	-	-	-	-	-	-	-	-	LRD 14	GV2 L14	0.330
-	-	-	-	-	-	7.5	4	100	10	138	LRD 14	GV2 L14	0.330
-	-	-	-	-	-	9	4	100	14	170	LRD 16	GV2 L16	0.330
5.5	50	50	7.5	10	75	11	4	100	14	170	LRD 16	GV2 L16	0.330
7.5	50	50	9	10	75	15	4	100	18	223	LRD 21	GV2 L20	0.330
9	50	50	11	10	75	18.5	4	100	25	327	LRD 22	GV2 L22	0.330
11	50	50	15	10	75	-	-	-	25	327	LRD 22	GV2 L22	0.330
15	35	50	18.5	10	75	22	4	100	32	416	LRD 32	GV2 L32	0.330

##### GV3 L: control by rotary knob, connection by EverLink® BTR screw connector

Standard power ratings of 3-phase motors 50/60 Hz in category AC-3									Magnetic protection rating	Tripping current Id ± 20 %	Use in association with thermal overload relay (class 10 A)	Reference	Weight
400/415 V			500 V			690 V							
P	Icu	Ics (1)	P	Icu	Ics (1)	P	Icu	Ics (1)					
kW	kA		kW	kA		kW	kA		A	A			kg
11	100	50	15	12	50	18,5	6	50	25	350	LRD 22	GV3 L25	1.000
15	100	50	18.5	12	50	22	6	50	32	448	LRD 32	GV3 L32	1.000
18,5	50	50	22	10	50	37	5	60	40	560	LRD 3355	GV3 L40	1.000
22	50	50	30	10	50	45	5	60	50	700	LRD 3357	GV3 L50	1.000
30	50	50	37	10	50	55	5	60	65	910	LRD 3359	GV3 L65	1.000

##### Connection by lugs

To order these circuit-breakers with connection by lugs, add the digit 6 to the end of reference selected above. Example: GV3 L32 becomes GV3 L326.

##### GK3: control by rotary knob, connection by screw clamp terminals

37	35	25	55	15	30	-	-	-	80	1040	LRD3363	GK3 EF80	0,795
----	----	----	----	----	----	---	---	---	----	------	---------	----------	-------

(1) As % of Icu. Associated current limiter or fuses, where required. See characteristics page 45.  
★ > 100 kA.

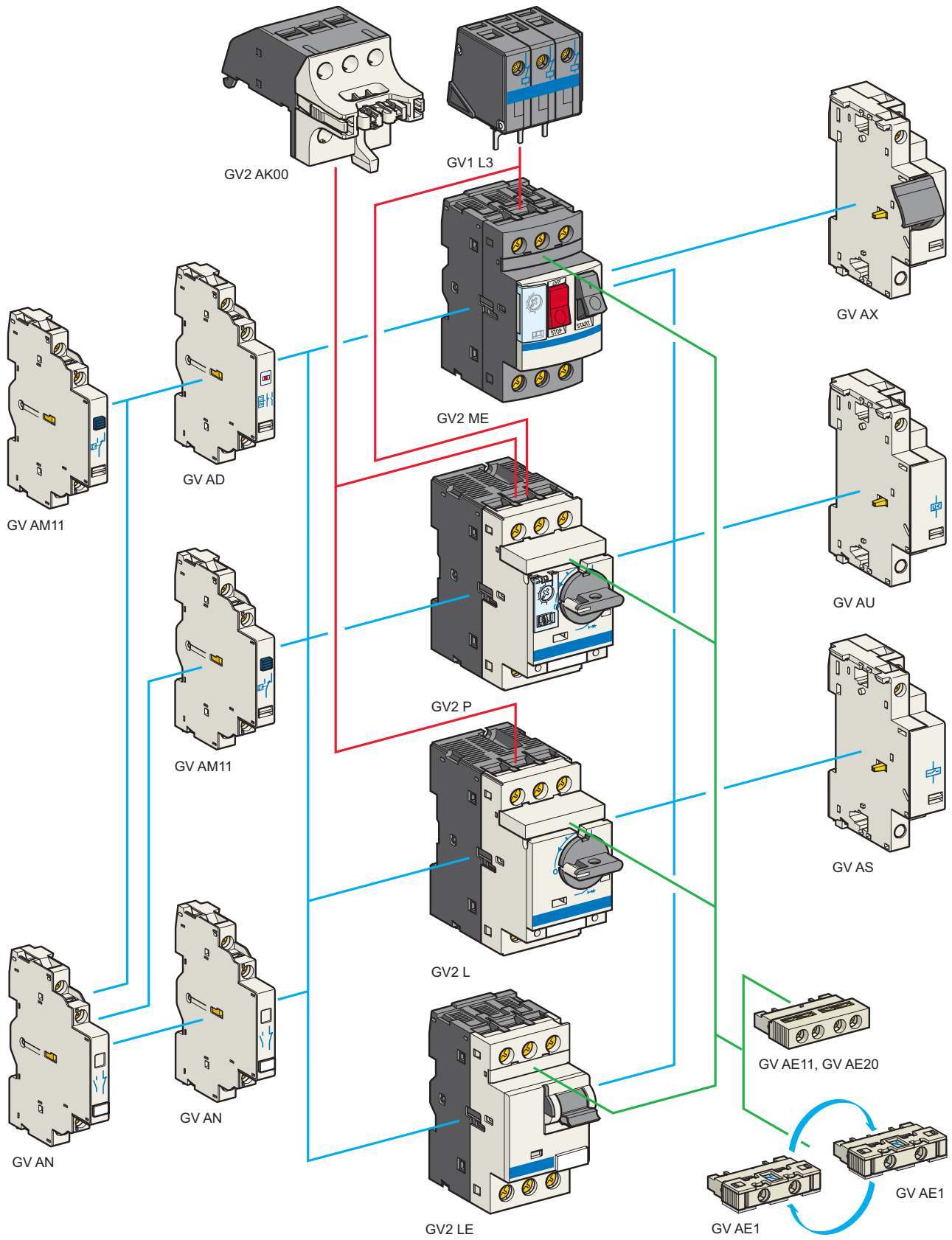

# TeSys protection components

## Thermal-magnetic and magnetic motor circuit-breakers GV2 with screw clamp connections

### Add-on blocks and accessories

Contact blocks							
Description	Mounting	Maximum number	Type of contacts	Sold in lots of	Unit reference	Weight kg	
Instantaneous auxiliary contacts	Front (1)	1	N/O or N/C (2)	10	GV AE1	0.015	
			N/O + N/C	10	GV AE11	0.020	
			N/O + N/O	10	GV AE20	0.020	
	Side (LH)	2	N/O + N/C	1	GV AN11	0.050	
			N/O + N/O	1	GV AN20	0.050	
Fault signalling contact + instantaneous auxiliary contact	Side (3) (LH)	1	N/O (fault)	+ N/O	1	GV AD1010	0.055
				+ N/C	1	GV AD1001	0.055
			N/C (fault)	+ N/O	1	GV AD0110	0.055
				+ N/C	1	GV AD0101	0.055
Short-circuit signalling contact	Side (LH)	1	C/O common point	1	GV AM11	0.045	

Electric trips				
Mounting	Voltage		Reference	Weight kg
<b>Undervoltage or shunt trips (4)</b>				
Side (1 block on RH side of circuit-breaker)	24 V	50 Hz	GV A●025	0.105
		60 Hz	GV A●026	0.105
	48 V	50 Hz	GV A●055	0.105
		60 Hz	GV A●056	0.105
	100 V	50 Hz	GV A●107	0.105
	100...110 V	60 Hz	GV A●107	0.105
	110...115 V	50 Hz	GV A●115	0.105
		60 Hz	GV A●116	0.105
	120...127 V	50 Hz	GV A●125	0.105
	127 V	60 Hz	GV A●115	0.105
	200 V	50 Hz	GV A●207	0.105
	200...220 V	60 Hz	GV A●207	0.105
	220...240 V	50 Hz	GV A●225	0.105
		60 Hz	GV A●226	0.105
	380...400 V	50 Hz	GV A●385	0.105
		60 Hz	GV A●386	0.105
	415...440 V	50 Hz	GV A●415	0.105
	415 V	60 Hz	GV A●416	0.105
	440 V	60 Hz	GV A●385	0.105
	480 V	60 Hz	GV A●415	0.105
500 V	50 Hz	GV A●505	0.105	
600 V	60 Hz	GV A●505	0.105	

Undervoltage trip, INRS (can only be mounted on GV2 ME)				
Safety device for dangerous machines conforming to INRS and VDE 0113				
Side (1 block on RH side of circuit-breaker GV2 ME)	110...115 V	50 Hz	GV AX115	0.110
		60 Hz	GV AX116	0.110
	127 V	60 Hz	GV AX115	0.110
		60 Hz	GV AX225	0.110
	220...240 V	50 Hz	GV AX225	0.110
		60 Hz	GV AX226	0.110
	380...400 V	50 Hz	GV AX385	0.110
		60 Hz	GV AX386	0.110
415...440 V	50 Hz	GV AX415	0.110	
440 V	60 Hz	GV AX385	0.110	

Add-on contact blocks				
Description	Mounting	Maximum number	Reference	Weight kg
Visible isolation block (5)	Front (1)	1	GV2 AK00	0.150
Limiters	At top (GV2 ME and GV2 P)	1	GV1 L3	0.130
	Independent	1	LA9 LB920	0.320

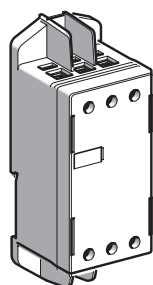

LA9 LB920

- (1) Mounting of a GV AE contact block or a GV2 AK00 visible isolation block on GV2 P and GV2 L.  
 (2) Choice of N/C or N/O contact operation, depending on which way round the reversible block is mounted.  
 (3) The GV AD is always mounted next to the circuit-breaker.  
 (4) To order an undervoltage trip: replace the dot (●) in the reference with a U, example: GV AU025.  
 To order a shunt trip: replace the dot (●) in the reference with an S, example: GV AS025.  
 (5) Visible isolation of the 3 poles upstream of circuit-breaker GV2 P and GV2 L.  
 Visible isolation block GV2 AK00 cannot be used with motor circuit-breakers GV2 P32 and GV2 L32 (Ith max = 25 A).

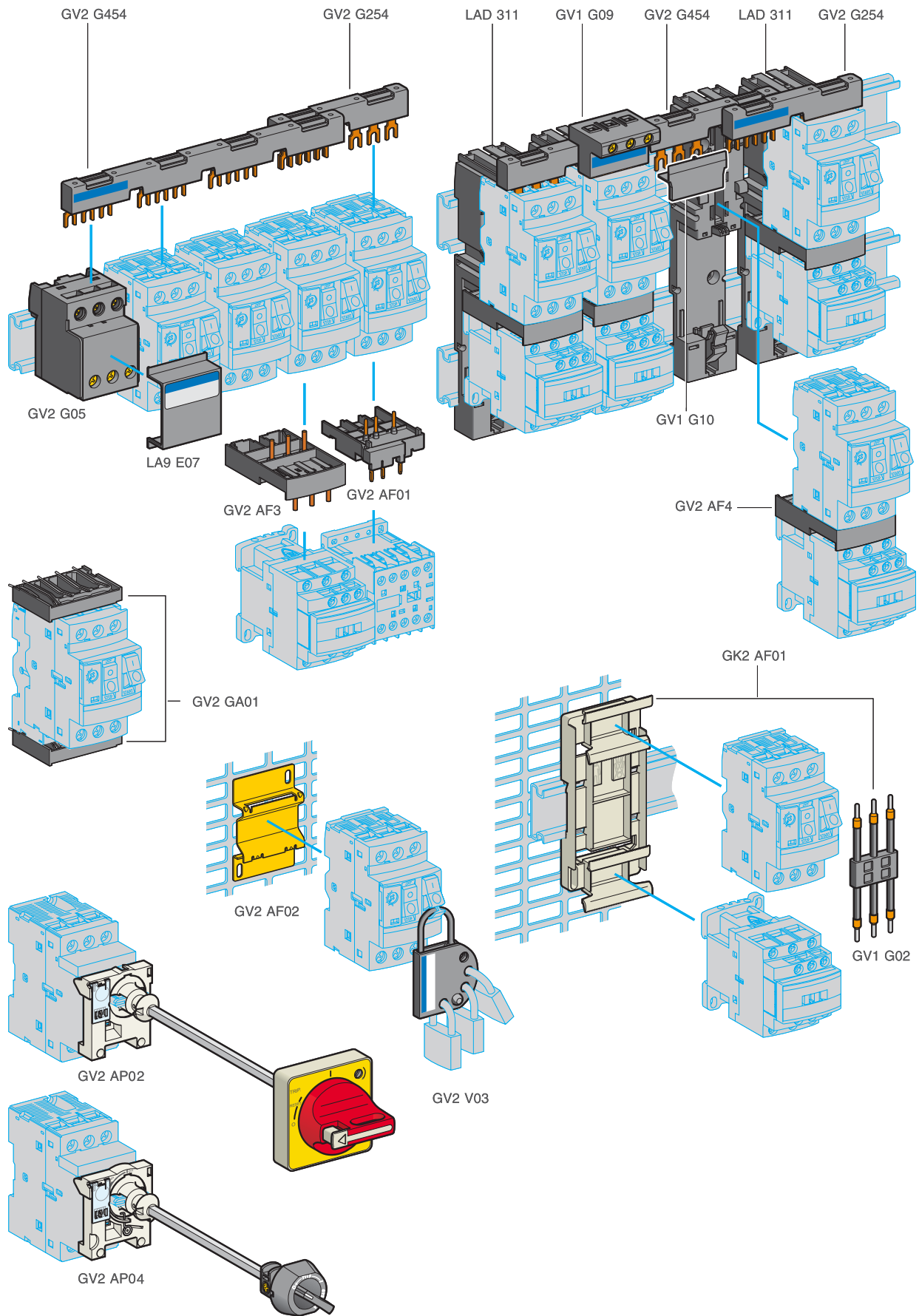



# TeSys protection components

## Thermal-magnetic and magnetic motor circuit-breakers GV2 with screw clamp connections

### Accessories

Accessories				
Description	Application	Sold in lots of	Unit reference	Weight kg
Adapter plates	For mounting a GV2 ME or GV2 LE by screw fixing	10	GV2 AF02	0.021
	For mounting a GV2 ME or GV2 P and contactor LC1 D09...D38 with front faces aligned	1	LAD 311	0.040
Height compensation plate	7,5 mm	10	GV1 F03	0.003
Combination blocks	Between GV2 and contactor LC1 K or LP1 K	10	GV2 AF01	0.020
	Between GV2 and contactor LC1 D09...D38	10	GV2 AF3	0.016
	Between GV2 mounted on LAD 311 and contactor LC1 D09...D38	10	GV2 AF4	0.016
Motor starter adapter plate	With 3-pole connection for mounting a GV2 and a contactor LC1 D09...D25	1	GK2 AF01	0.120

Description	Application	Pitch mm	Reference	Weight kg
Sets of 3-pole 63 A busbars	2 tap-offs	45	GV2 G245	0.036
		54	GV2 G254	0.038
		72	GV2 G272	0.042
	3 tap-offs	45	GV2 G345	0.058
		54	GV2 G354	0.060
		72	GV2 G472	0.094
	4 tap-offs	45	GV2 G445	0.077
		54	GV2 G454	0.085
		72	GV2 G472	0.094
	5 tap-offs	54	GV2 G554	0.100

Description	Application	Sold in lots of	Unit reference	Weight kg
Protective end cover	For unused busbar outlets	5	GV1 G10	0.005
Terminal block for supply to one or more GV2 G busbar sets	Connection from the top	1	GV1 G09	0.040
	Can be fitted with current limiter GV1 L3 (GV2 ME and GV2 P)	1	GV2 G05	0.115
Cover for terminal block	For mounting in modular panels	10	LA9 E07	0.005
Flexible 3-pole connection for connecting a GV2 to a contactor LC1-D09...D25	Centre distance between mounting rails: 100...120 mm	10	GV1 G02	0.013
Set of connections upstream/downstream	For connecting GV2 ME to a printed circuit board	10	GV2 GA01	0.045
"Large Spacing" adapter UL 508 type E	For GV2 P●●H7 (except 32 A)	1	GV2 GH7	0.040
Clip-in marker holders (supplied with each circuit-breaker)	For GV2 P, GV2 L, GV2 LE and GV2 RT (8 x 22 mm)	100	LA9 D92	0.001

External operators			
Description		Reference	Weight kg
For GV2 P and GV2 L (150 to 290 mm)	Padlocking in "On" and "Off" position Black handle, blue front plate, IP 54	GV2 AP01	0.200
	Padlocking in "Off" position Red handle, yellow front plate, IP 54	GV2 AP02	0.200
	Cannot be padlocked in "On" and "Off" positions Does not lock the door or drawer operator in the "On" position. Colour: RAL 7016, IP 42	GV2 AP04	0.104
For GV2 LE	Padlocking in "On" and "Off" position Black handle, blue front plate, IP 54	GV2 AP03	0.280

Padlocking device			
Description		Reference	Weight kg
For all GV2 device	For use with up to 4 padlocks, Ø 6 mm shank max. (padlocks not included)	GV2 V03	0.092

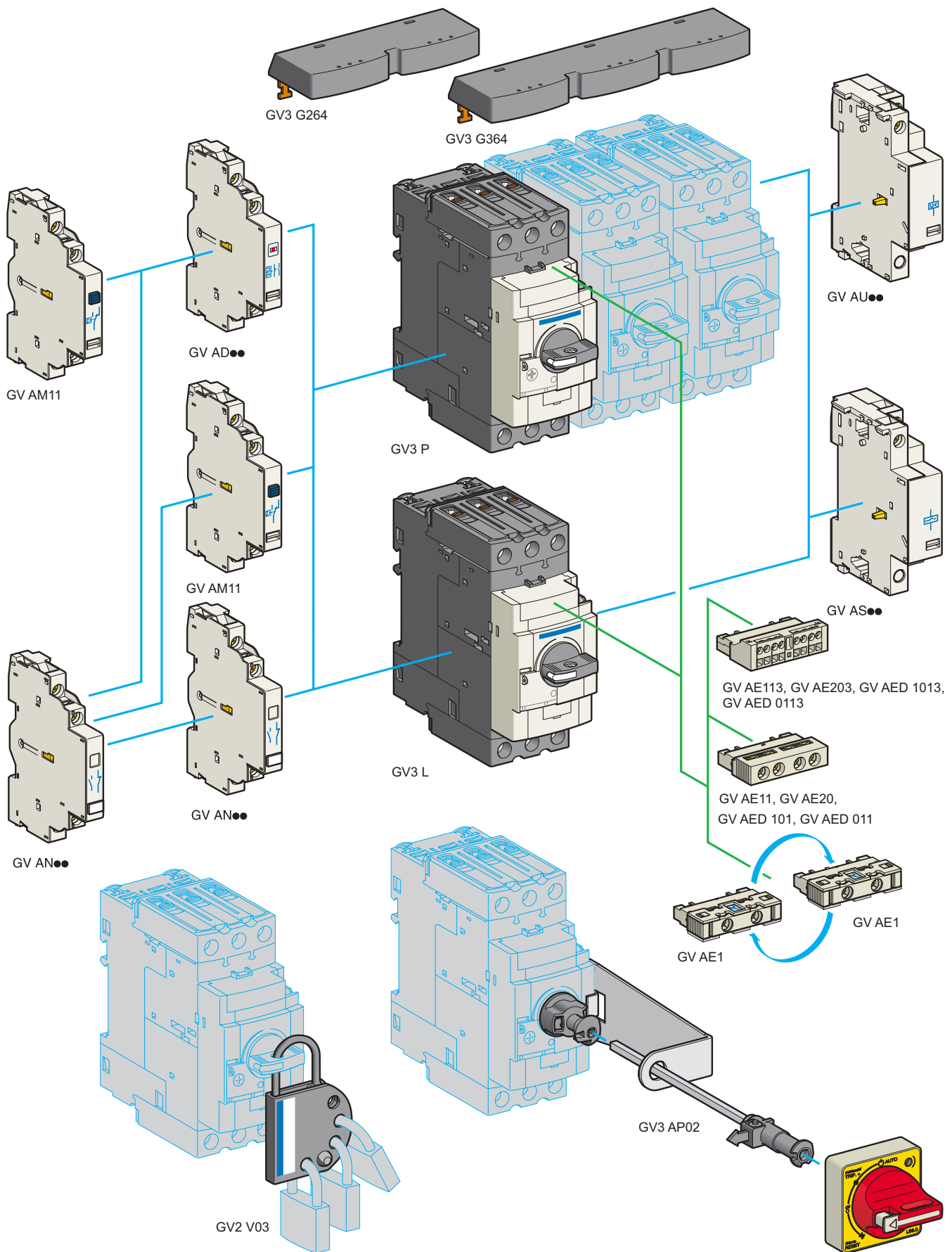

# TeSys protection components

## Thermal-magnetic motor circuit-breakers

### GV3 P and GV3 L

#### Add-on blocks and accessories

Contact blocks						
Description	Mounting	Maximum number	Type of contacts	Sold in lots of	Unit reference	Weight kg
Instantaneous auxiliary contacts	Front	1	N/O or N/C (1)	10	GV AE1	0.015
			N/O + N/C	10	GV AE11 (2)	0.020
			N/O + N/O	10	GV AE20 (2)	0.020
	Side (LH)	2	N/O + N/C	1	GV AN11 (2)	0.050
			N/O + N/O	1	GV AN20 (2)	0.050
Fault signalling contact + instantaneous auxiliary contact	Front	1	N/O (fault) + N/O	1	GV AED101 (2)	0.020
			N/O (fault) + N/C	1	GV AED011 (2)	0.020
	Side (3) (LH)	1	N/O (fault) + N/O	1	GV AD1010	0.055
			+ N/C	1	GV AD1001	0.055
		N/C (fault) + N/O	1	GV AD0110	0.055	
			+ N/C	1	GV AD0101	0.055
Short-circuit signalling contact	Side (LH)	1	C/O common point	1	GV AM11	0.045

Electric trips - undervoltage or shunt (4)				
Mounting	Voltage		Reference	Weight kg
Side (1 block on RH side of circuit-breaker)	24 V	50 Hz	GV A●025	0.105
		60 Hz	GV A●026	0.105
	48 V	50 Hz	GV A●055	0.105
		60 Hz	GV A●056	0.105
	100	50 Hz	GV A●107	0.105
	100...110 V	60 Hz	GV A●107	0.105
	110...115 V	50 Hz	GV A●115	0.105
		60 Hz	GV A●116	0.105
	120...127 V	50 Hz	GV A●125	0.105
	127 V	60 Hz	GV A●115	0.105
	200 V	50 Hz	GV A●207	0.105
	200...220 V	60 Hz	GV A●207	0.105
	220...240 V	50 Hz	GV A●225	0.105
		60 Hz	GV A●226	0.105
	380...400 V	50 Hz	GV A●385	0.105
		60 Hz	GV A●386	0.105
	415...440 V	50 Hz	GV A●415	0.105
	415 V	60 Hz	GV A●416	0.105
	440 V	60 Hz	GV A●385	0.105
	480 V	60 Hz	GV A●415	0.105
500 V	50 Hz	GV A●505	0.105	
600 V	60 Hz	GV A●505	0.105	

Padlockable external operators for GV3 P and GV3 L			
Description		Reference	Weight kg
External operators comprising: an LU9 AP1● handle, a shaft (max. length: 260 mm), a bracket and an adaptor.	Padlocking in "On" and "Off" position Black handle, blue front plate, IP 54	GV3 AP01	0.294
	Padlocking in "Off" position Red handle, yellow front plate, IP 54	GV3 AP02	0.294
Handles only	Black handle, blue front plate, IP 54	LU9 AP11	0.105
	Red handle, yellow front plate, IP 54	LU9 AP12	0.105

Accessories				
Description	For circuit-breakers		Reference	Weight kg
Sets of 3-pole 115 A busbars Pitch: 64 mm	2 tap-off	GV3 P●● and GV3 L●●	GV3 G264 ▲	0.150
	3 tap-off	GV3 P●● and GV3 L●●	GV3 G364	0.250
Cover "Large Spacing" UL 508 type E (Only one cover required on supply side)		GV3 P●●	GV3 G66	0.020
IP 20 cover (Two covers required per breaker)		GV3 P●●6 and GV3 L●●6	LAD 96570	0.021
Padlocking device		GV3 P●● and GV3 L●●	GV2 V03	0.092
for use with up to 4 padlocks (not supplied) Ø 6 mm shank max.		GV3 P●●6 and GV3 L●●6		
Retrofit plate for screw fixing	Replacement of GV3 ME with GV3 P●●		LAD 7X3 ▲	0.150

- (1) Choice of N/C or N/O contact operation, depending on which way round the reversible block is mounted.
- (2) Contact blocks available in version with spring terminal connections. Add a figure 3 at the end of the references selected above.  
Example: GV AED101 becomes GV AED1013.
- (3) The GV AD●● is always mounted next to the circuit-breaker.
- (4) To order an undervoltage trip: replace the dot (●) in the reference with a U, example: GV AU025.  
To order a shunt trip: replace the dot (●) in the reference with an S, example: GV AS025.

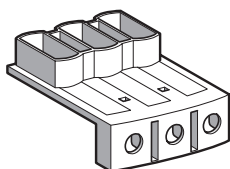

GV3 G66

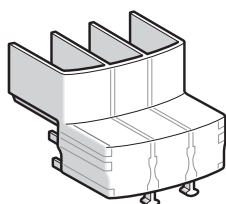

LAD 96570

▲ available  
1<sup>st</sup> quarter 2008

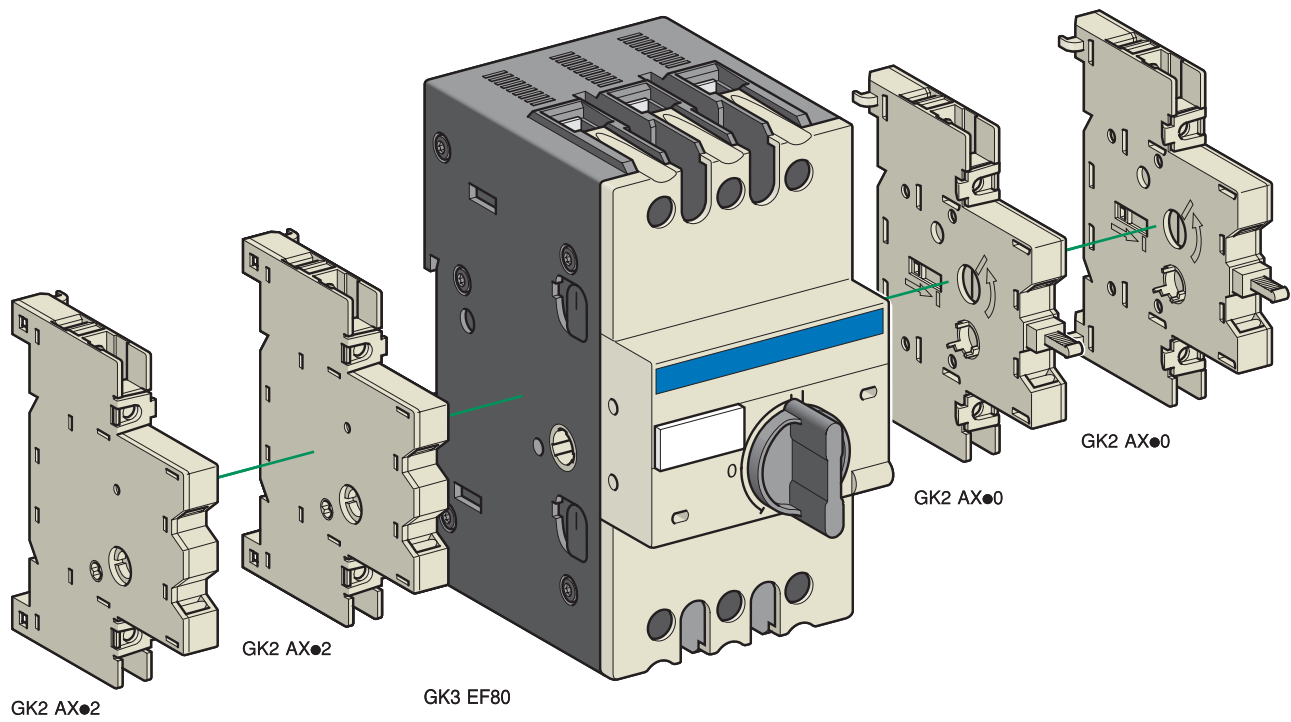
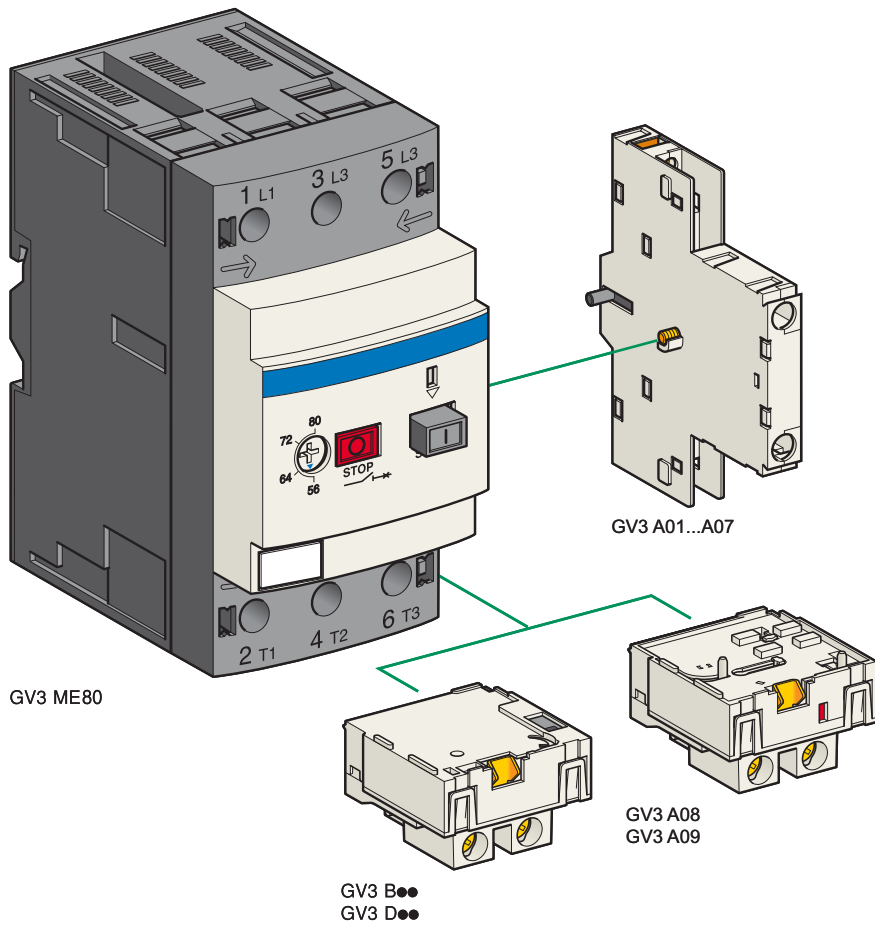

# TeSys protection components

## Motor circuit-breakers GV3 ME80 and

## GK3 EF80

### Add-on blocks and accessories

#### For thermal-magnetic motor circuit-breakers GV3 ME80

##### Contact blocks

Description	Type of standard early break contacts	Reference	Weight kg
Instantaneous auxiliary contact blocks (1 per circuit-breaker)	N/C + N/O	GV3 A01	0,060
	N/O + N/O	GV3 A02	0.060
	N/C + N/O + N/O	GV3 A03	0.070
	N/O + N/O + N/O	GV3 A05	0.070
	N/O + N/O + 2 volt-free terminals	GV3 A06	0.070
	N/C + N/O + 2 volt-free terminals	GV3 A07	0.070
Fault signalling contacts (1)	N/C	GV3 A08	0.030
	N/O	GV3 A09	0.030

##### Electric trips

Description	Voltages		Reference	Weight kg
	50 Hz	60 Hz		
Undervoltage trips (1)	110, 120, 127 V	120, 127 V	GV3 B11	0.070
	220, 240 V	277 V	GV3 B22	0.070
	380, 415 V	440 V, 480 V	GV3 B38	0.070
Shunt trips (1)	110, 120, 127 V	120, 127 V	GV3 D11	0.070
	220, 240 V	277 V	GV3 D22	0.070
	380, 415 V	440 V, 480 V	GV3 D38	0.070

##### Accessory

Description	Sold in lots of	Unit reference	Weight kg
Padlocking device, for locking the Start button (on open-mounted product)	5	GV1 V02	0.010

#### For magnetic circuit-breaker GK3 EF80

##### Contact blocks

Description	Number of poles	Reference	Weight kg
Auxiliary contact blocks for On-Off signalling and "control circuit test" function (1 or 2 blocks per device) mounted on RH side of GK3 EF80	N/O	GK2 AX10	0.025
	N/O + N/O	GK2 AX20	0.031
	N/C + N/O	GK2 AX50	0.031
Instantaneous fault signalling contact blocks (1 or 2 blocks per device) mounted on LH side of GK3 EF80	N/O	GK2 AX12	0.025
	N/O + N/O	GK2 AX22	0.031
	N/C + N/O	GK2 AX52	0.031

##### Accessories

Description	Reference	Weight kg
Padlocking device for padlocking the operator, using up to 3 padlocks (padlocks to be ordered separately)	GK3 AV01	0.020
External operator for mounting on enclosure door. Red Ø 40 knob on yellow plate, padlockable in position O (with up to 3 padlocks). Door locked when knob in position I, and when knob padlocked in position O.	GK3 AP03	0.300

(1) 1 voltage trip OR 1 fault signalling contact to be fitted inside the motor circuit-breaker.

##### Other versions

24 to 690 V, 50 or 60 Hz voltage trips for circuit-breakers **GV3 ME80**. Please consult your Regional Sales Office.

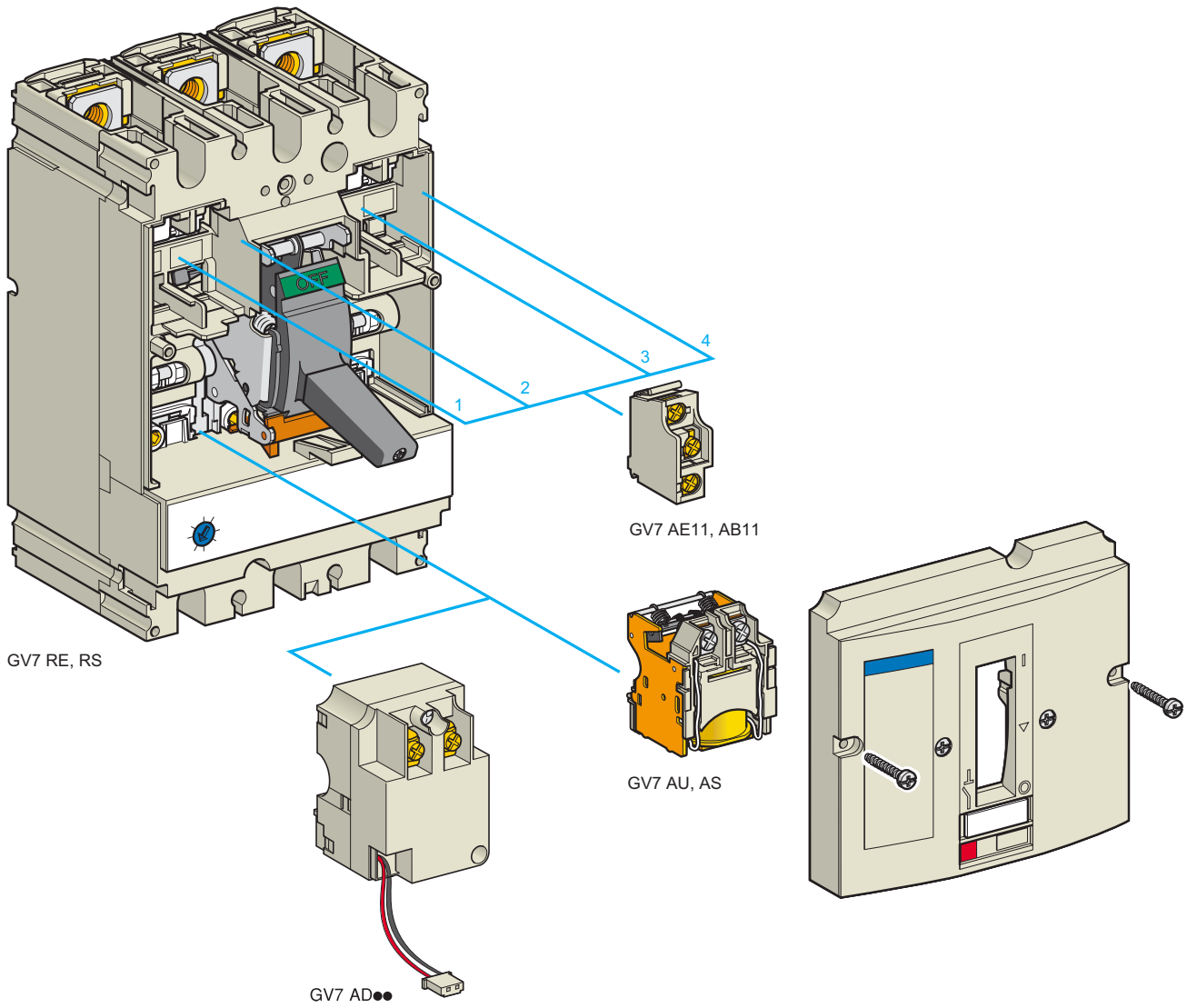

# TeSys protection components

## Thermal-magnetic motor circuit-breakers

### GV7 R with screw clamp connections

#### Add-on blocks and accessories

#### Add-on auxiliary contacts

These allow remote indication of the circuit-breaker contact states. They can be used for signalling, electrical locking, relaying, etc. They are available in two versions: standard and low level. They include a terminal block and the auxiliary circuits leave the circuit-breaker through a hole provided for this purpose.

They perform the following functions, depending on where they are located in the circuit-breaker:

Location	Function	Application
1 and/or 4	C/O contact	Indicates the position of the circuit-breaker poles
2	Trip indication	Indicates that the circuit-breaker has tripped due to an overload, a short-circuit, a differential fault or the operation of a voltage trip (undervoltage or shunt trip), or of the "push to trip" test button. It resets when the circuit-breaker is reset.
3	Electrical fault indication	Indicates that the circuit-breaker has tripped due to an overload, a short-circuit or a differential fault. It resets when the circuit-breaker is reset.

Type	Reference	Weight kg
Standard	GV7 AE11	0.015
Low level	GV7 AB11	0.015

#### Fault discrimination devices

These make it possible to:

- either differentiate a thermal fault from a magnetic fault,
- or open the contactor only in the event of a thermal fault.

Voltage	Reference	Weight kg
$\sim$ 24...48 and $\equiv$ 24...72 V	GV7 AD111 (1)	0.100
$\sphericalangle$ 110...240 V	GV7 AD112 (1)	0.100

#### Electric trips

These allow the circuit-breaker to be tripped via an electrical control signal.

- Undervoltage trip GV7 AU
  - Trips the circuit-breaker when the control voltage drops below the tripping threshold, which is between 0.35 and 0.7 times the rated voltage.
  - Circuit-breaker closing is only possible if the voltage exceeds 0.85 times the rated voltage.
 Circuit-breaker tripping by a GV7 AU trip meets the requirements of IEC 60947-2.
- Shunt trip GV7 AS
  - Trips the circuit-breaker when the control voltage rises above 0.7 times the rated voltage.
- Operation (GV7 AU or GV7 AS)
  - When the circuit-breaker has been tripped by a GV7 AU or AS, it must be reset either locally or by remote control. (For remote control, please consult your Regional Sales Office).
  - Tripping has priority over manual closing: if a tripping instruction is present, manual action does not result in closing, even temporarily, of the contacts.
  - Durability: 50 % of the mechanical durability of the circuit-breaker.

Type	Voltage	Reference	Weight kg
Undervoltage trip	48 V, 50/60 Hz	GV7 AU055 (1)	0.105
	110...130 V, 50/60 Hz	GV7 AU107 (1)	0.110
	200...240 V, 50/60 Hz	GV7 AU207 (1)	0.110
	380...440 V, 50/60 Hz	GV7 AU387 (1)	0.105
	525 V, 50 Hz	GV7 AU525 (1)	0.100
Shunt trip	48 V, 50/60 Hz	GV7 AS055 (1)	0.105
	110...130 V, 50/60 Hz	GV7 AS107 (1)	0.110
	200...240 V, 50/60 Hz	GV7 AS207 (1)	0.110
	380...440 V, 50/60 Hz	GV7 AS387 (1)	0.105
	525 V, 50 Hz	GV7 AS525 (1)	0.100

(1) For mounting of a GV7 AD or a GV7 AU or AS.

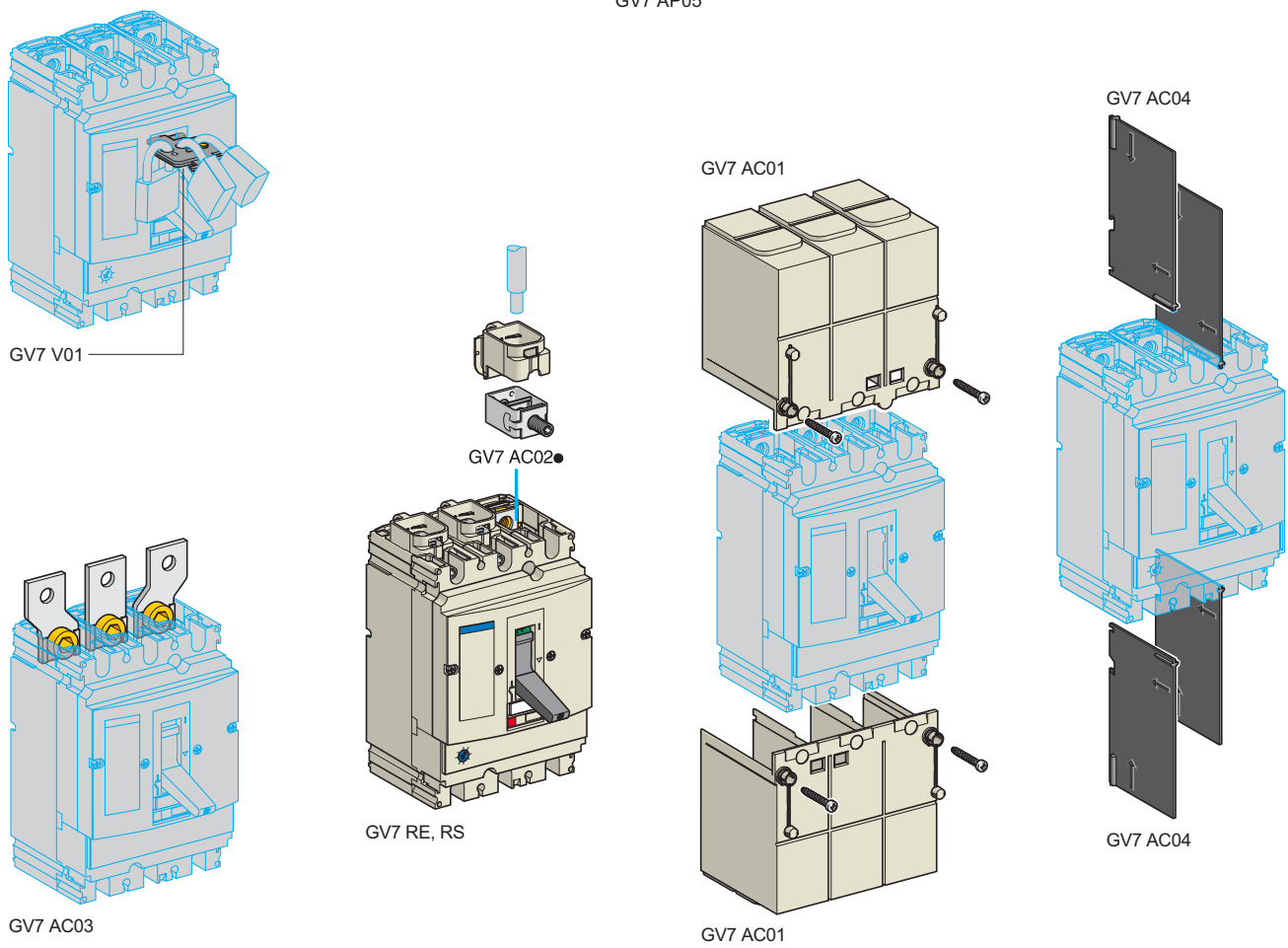
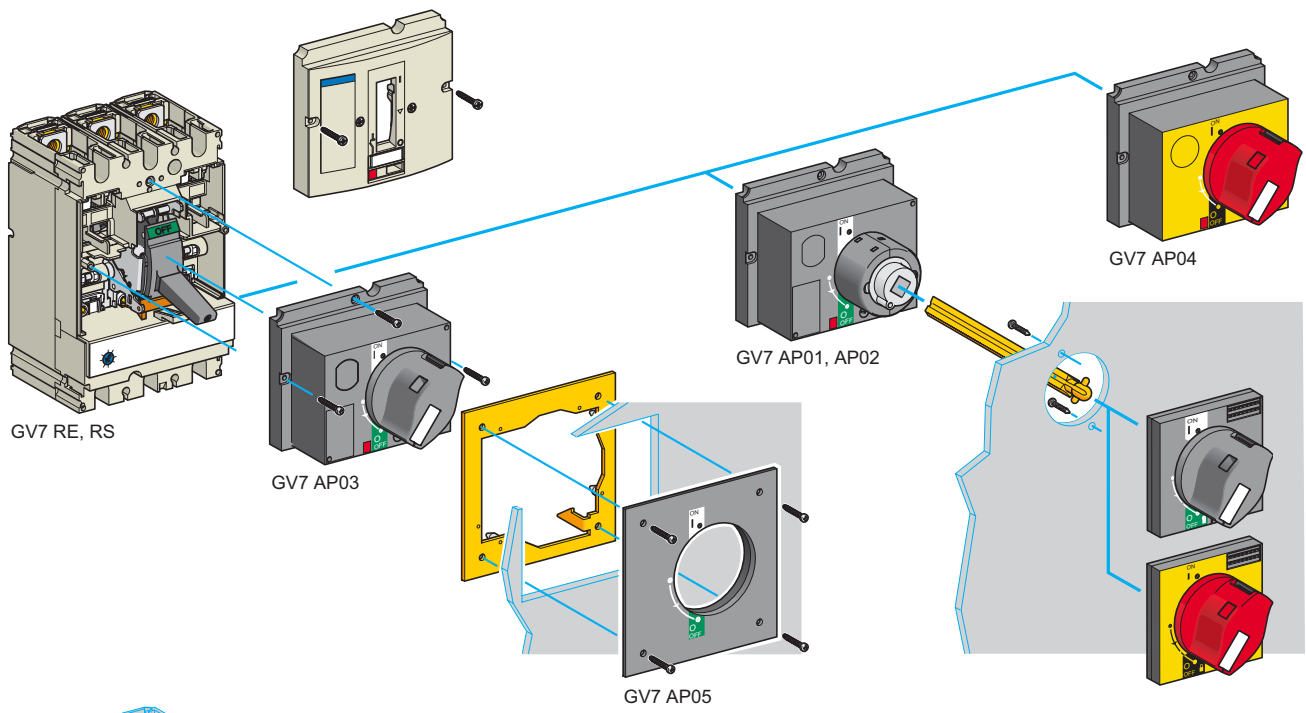



# TeSys protection components

## Thermal-magnetic motor circuit-breakers

### GV7 R with screw clamp connections

#### Accessories

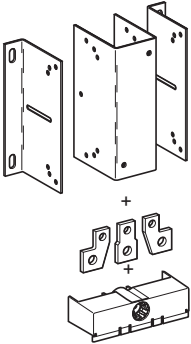

GV7 AC07

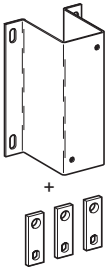

GV7 AC08

### Cabling accessories

Description	Application	For use on contactors	Sold in lots of	Unit reference	Weight kg
<b>Clip-on connectors for GV7 R</b>	Up to 150 A, 1.5...95 mm <sup>2</sup>	–	3	<b>GV7 AC021</b>	0.300
	Up to 220 A, 1.5...185 mm <sup>2</sup>	–	3	<b>GV7 AC022</b>	0.350
<b>Spreader 3-pole (1)</b>	To increase the pitch to 45 mm	–	1	<b>GV7 AC03</b>	0.180
<b>Terminal shields IP 405 (1)</b>	Supplied with sealing accessory	–	1	<b>GV7 AC01</b>	0.125
<b>Phase barriers</b>	Safety accessories used when fitting of shields is impossible	–	2	<b>GV7 AC04</b>	0.075
<b>Insulating screens</b>	Ensure insulation between the connections and the backplate	–	2	<b>GV7 AC05</b>	0.075
<b>Kits for combination with contactor(2)</b>	Allowing link between the circuit-breaker and the contactor. The cover provides protection against direct finger contact	LC1 F115...F185	1	<b>GV7 AC06</b>	0.550
		LC1 F225 and F265	1	<b>GV7 AC07</b>	0.550
		LC1 D115 and D150	1	<b>GV7 AC08</b>	0.550

### Direct rotary handle

Replaces the circuit-breaker front cover; secured by screws. It includes a device for locking the circuit-breaker in the O (Off) position by means of up to 3 padlocks with a shank diameter of 5 to 8 mm (padlocks not included). A conversion accessory allows the direct rotary handle to be mounted on the enclosure door. In this case, the door cannot be opened if the circuit-breaker is in the "ON" position. Circuit-breaker closing is inhibited if the enclosure door is open.

Description	Type	Degree of protection	Reference	Weight kg
<b>Direct rotary handle</b>	Black handle, black legend plate	IP 40	<b>GV7 AP03</b>	0.205
	Red handle, yellow legend plate	IP 40	<b>GV7 AP04</b>	0.205
<b>Adapter plate (3)</b>	Four mounting direct rotary handle on enclosure door	IP 43	<b>GV7 AP05</b>	0.100

### Extended rotary handle

Allows a circuit-breaker installed in the back of an enclosure to be operated from the front of the enclosure. It comprises:

- a unit which screws onto the front cover of the circuit-breaker,
- an assembly (handle and front plate) to be fitted on the enclosure door,
- an extension shaft which must be adjusted (distance between the mounting surface and the door: 185 mm minimum, 600 mm maximum). It includes a device for locking the circuit-breaker in the O (Off) position by means of up to 3 padlocks with a shank diameter of 5 to 8 mm (padlocks not included). This prevents the enclosure door from being opened.

Description	Type	Degree of protection	Reference	Weight kg
<b>Extended rotary handle</b>	Black handle, black legend plate	IP 55	<b>GV7 AP01</b>	0.775
	Red handle, yellow legend plate	IP 55	<b>GV7 AP02</b>	0.775

### Locking device

Allows circuit-breakers not fitted with a rotary handle to be locked in the O (Off) position by means of up to 3 padlocks with a shank diameter of 5 to 8 mm (padlocks not included).

Description	Application	Reference	Weight kg
<b>Locking device</b>	For circuit-breaker not fitted with a rotary handle	<b>GV7 V01</b>	0.100

(1) Terminal shields cannot be used together with spreaders.

(2) The kit comprises links, a protective shield and a depth adjustable metal bracket for the breaker.

(3) This conversion accessory makes it impossible to open the door if the device is closed and prevents the device from being closed if the door is open.

### Dimensions

#### GV2 ME

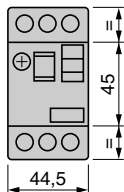
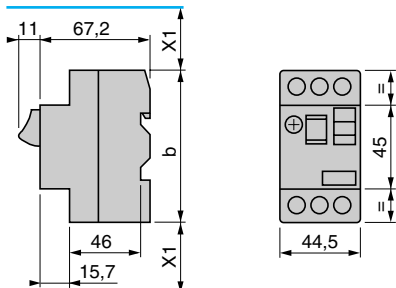

#### GV AX

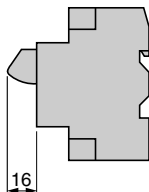

#### GV AD, AM, AN, AU, AS, AX

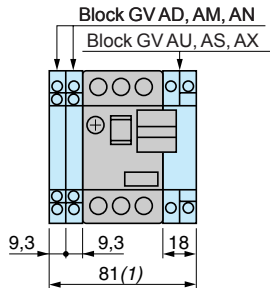

#### GV AE

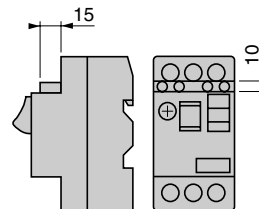

**b**

GV2 ME●●	89
GV2 ME●●3	101

(1) Maximum  
X1 Electrical clearance = 40 mm for  $U_e \leq 690$  V

#### GV2 P

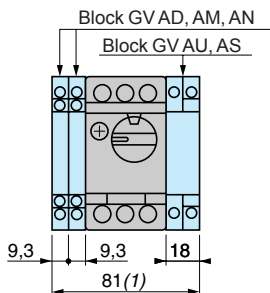
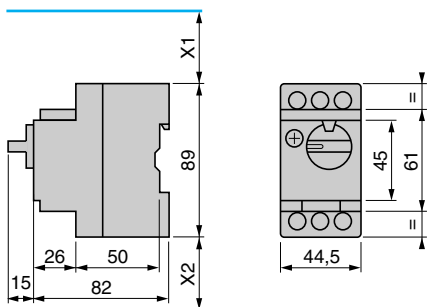

#### GV2 AK00

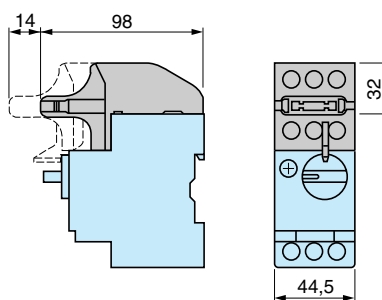

(1) Maximum  
X1 Electrical clearance = 40 mm for  $U_e \leq 415$  V, or 80 mm for  $U_e = 440$  V, or 120 mm for  $U_e = 500$  and 690 V  
X2 = 40 mm

### Mounting

#### GV2 ME

On 35 mm rail

On panel with adapter plate GV2 AF02

On pre-slotted plate AM1 PA

On rails DZ5 MB201

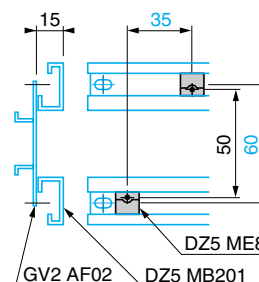
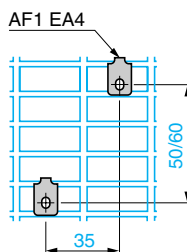
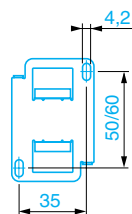
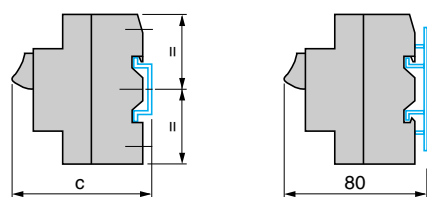

$c = 78.5$  on AM1 DP200 (35 x 7.5)  
 $c = 86$  on AM1 DE200, ED200 (35 x 15)

#### GV2 P

On rail AM1 DE200, ED200 (35 x 15)

Panel mounted

On pre-slotted plate AM1 PA

Adapter plate GK2 AF01

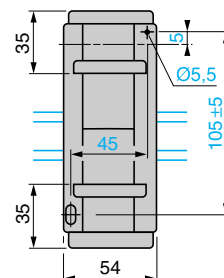
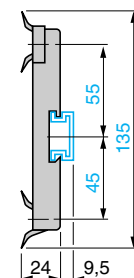
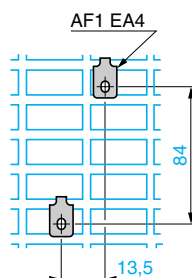
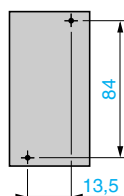
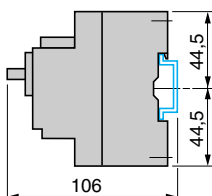

## Dimensions

### GV2 AF01

Combination GV2 ME + TeSys k contactor

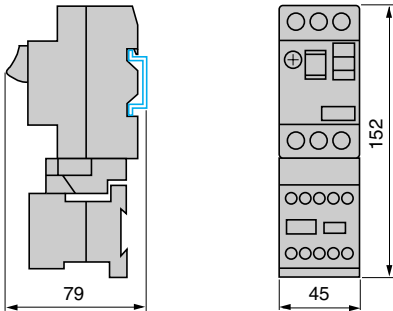

### GV2 AF3

Combination GV2 ME + TeSys d contactor

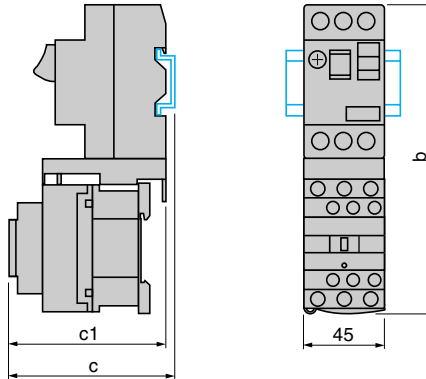

Combination GV2 P + TeSys d contactor

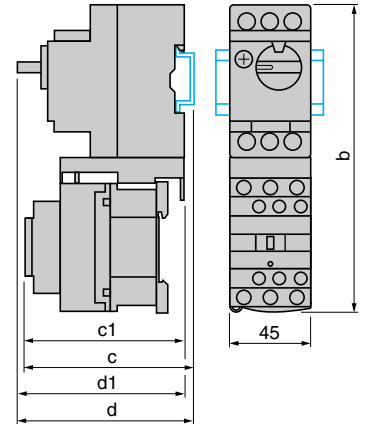

GV2 ME +	LC1 D09...D18	LC1 D25 & D32
b	176.4	186.8
c1	94.1	100.4
c	99.6	105.9

GV2 P +	LC1 D09...D18	LC1 D25 & D32
b	176.4	186.8
c1	100.1	106.4
c	105.6	111.9
d1	95	95
d	100.5	100.5

### GV2 AF4 + LAD 311

Combination GV2 ME + TeSys d contactor

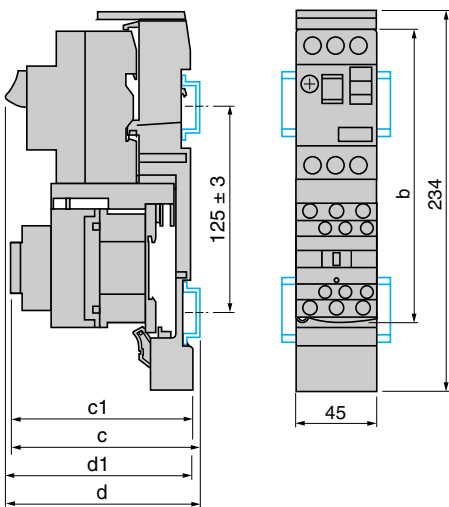

Combination GV2 P + TeSys d contactor

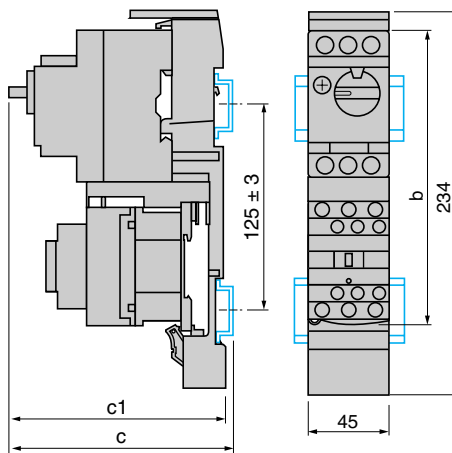

GV2 ME + GV1 L3 (current limiter)

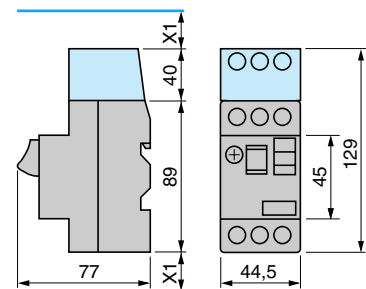

X1 = 10 mm for Ue = 230 V  
or 30 mm for 230 V < Ue ≤ 690 V

7.5 mm height compensation plate  
GV1 F03



GV2 ME +	LC1 D09...D18	LC1 D25 & D32
b	176.4	186.8
c1	103.1	136.4
c	135.6	141.9
d1	107	107
d	112.5	112.5

GV2 P +	LC1 D09...D18	LC1 D25 & D32
b	176.4	186.8
c1	136.5	142.4
c	141.6	147.9

## Mounting

Mounting of external operator GV2 AP01 or GV2 AP02 for motor circuit-breakers GV2 P

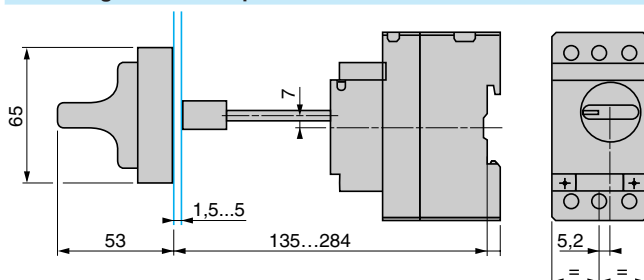

Door cut-out

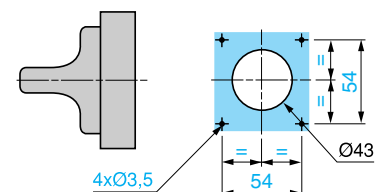

## GV2 ME, GV2 P

Sets of busbars GV2 G445, GV2 G454, GV2 G472, with terminal block GV2 G05

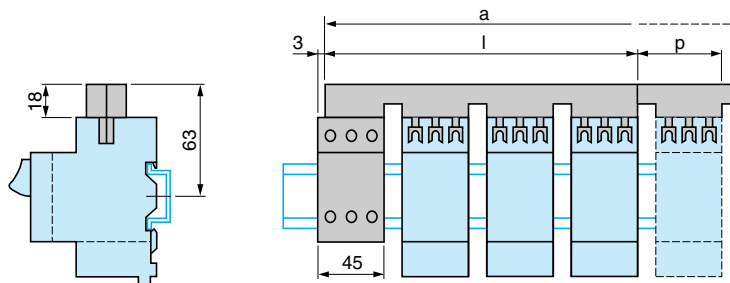

	l	p
GV2 G445 (4 x 45 mm)	179	45
GV2 G454 (4 x 54 mm)	206	54
GV2 G472 (4 x 72 mm)	260	72

Number of tap-offs	a			
	5	6	7	8
GV2 G445	224	269	314	359
GV2 G454	260	314	368	422
GV2 G472	332	404	476	548

Sets of busbars GV2 G●●● with terminal block GV1 G09

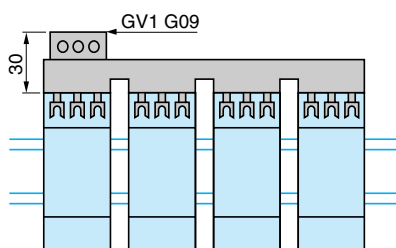

Sets of busbars GV2 G245, GV2 G254, GV2 G272

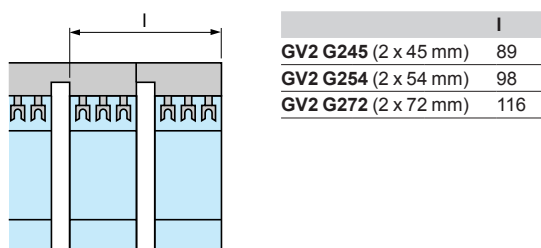

	l
GV2 G245 (2 x 45 mm)	89
GV2 G254 (2 x 54 mm)	98
GV2 G272 (2 x 72 mm)	116

Sets of busbars GV2 G554

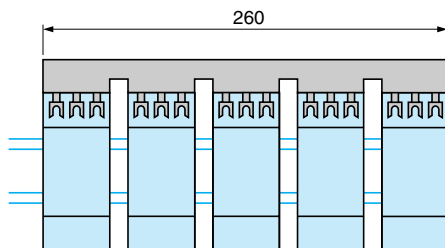

Sets of busbars GV2 G345 and GV2 G354

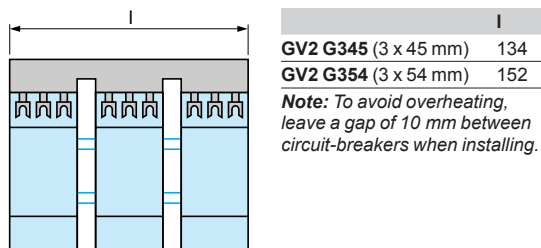

	l
GV2 G345 (3 x 45 mm)	134
GV2 G354 (3 x 54 mm)	152

*Note: To avoid overheating, leave a gap of 10 mm between circuit-breakers when installing.*

## GV2 RT

Dimensions

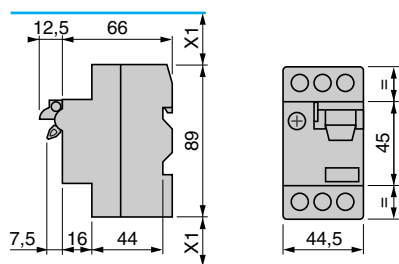

Mounting of external operator GV2 AP03

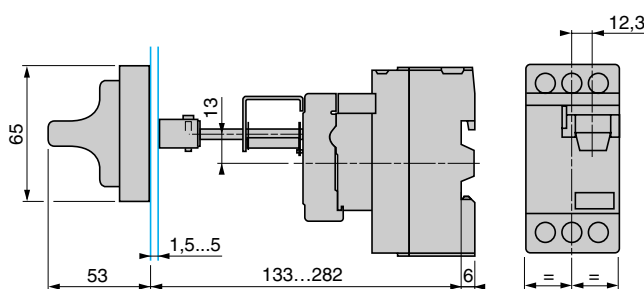

X1: Electrical clearance = 40 mm for Ue < 690 V

Mounting

On 35 mm mounting rail

On panel with adapter plate GV2 AF02

On pre-slotted plate AM1 PA

On rails DZ5 MB

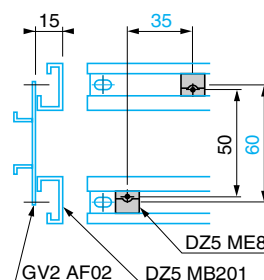
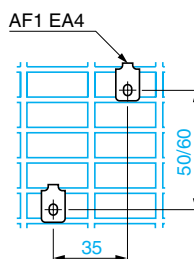
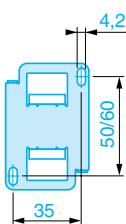
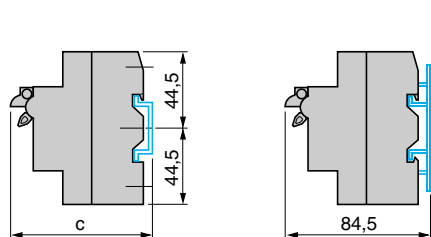

c = 80 on AM1 DP200 (35 x 7.5)  
c = 88 on AM1 DE200, ED200 (35 x 15)

#### GV3 P

#### Dimensions

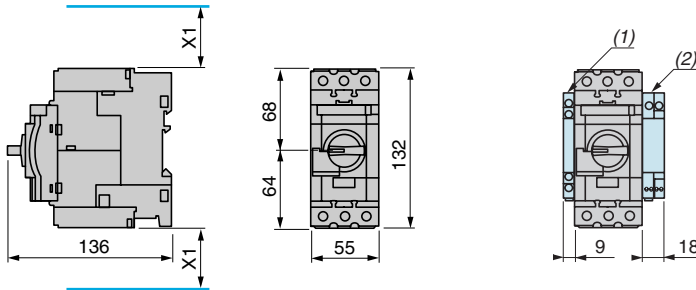

X1 = Electrical clearance (ISC max)  
40 mm for  $U_e \leq 500$  V, 50 mm for  $U_e \leq 690$  V

(1) Blocks GV AN●●, GV AD●● and GV AM11  
(2) Blocks GV3 AU●● and GV3 AS●●

**Note:** Leave a space of 9 mm between 2 circuit-breakers: either an empty space or side-mounting add-on contact blocks.  
Side by side mounting is possible up to 40 °C

#### Mounting

##### Mounting with Tesys contactor LC1 D40A...D65A

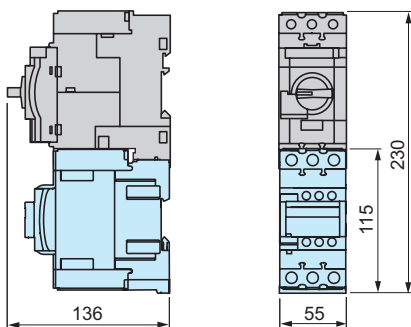

##### Side by side mounting with Tesys contactor LC1 D40A...D65A (S-shape busbar system GV3 S)

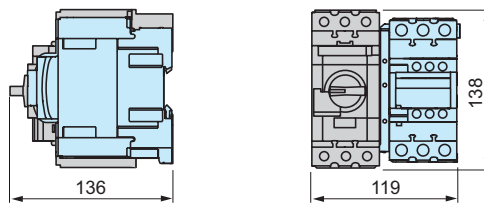

##### Mounting on rail AM1 DE200 or AM1 ED201

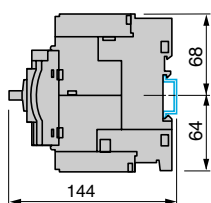

##### Mounting on panel, using M4 screws

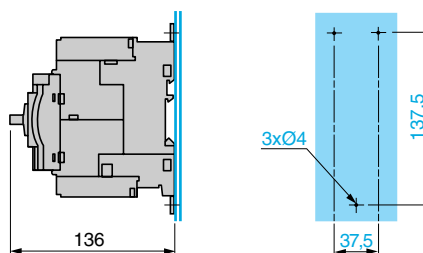

##### Mounting on pre-slotted mounting plate AM1 PA

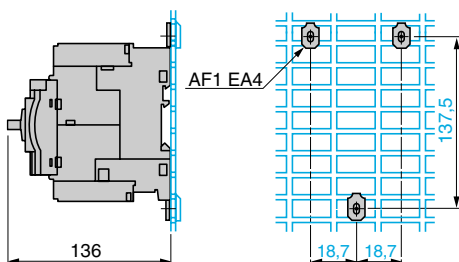

### GV3 P (Continued)

#### Sets of busbars

##### Set of busbars GV3 G264

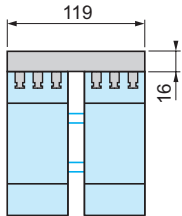

##### Set of busbars GV3 G364

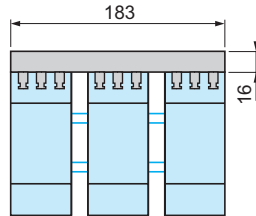

**Note:** Leave a space of 9 mm between 2 circuit-breakers: either an empty space or side-mounting add-on contact blocks. Side by side mounting is possible up to 40 °C.

#### Mounting of external operator GV3 AP01 or GV3 AP02

##### Depth 131 mm

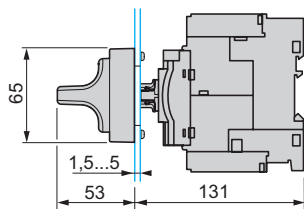

##### Depth 231 to 390 mm

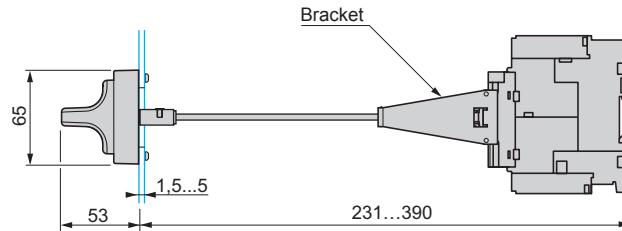

##### Depth 177 to 230 mm

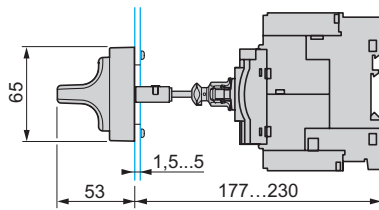

#### Door cut-out

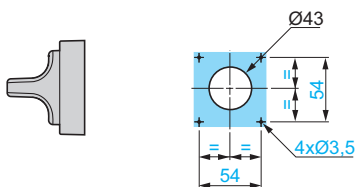

#### GV7 R

#### Dimensions

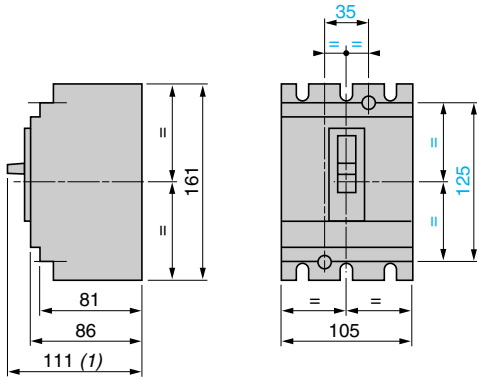

(1) 126 for GV7 R●220

#### Motor circuit-breakers with terminal shields or phase barriers GV7 R + GV7 AC01 or AC04

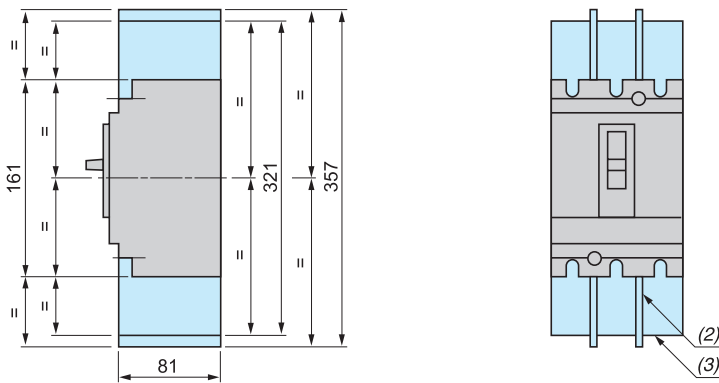

(2) Phase barriers: GV7 AC04  
(3) Terminal shields: GV7 AC01

#### Combination of GV7 R and TeSys contactor LC1 F with kit GV7 AC0●

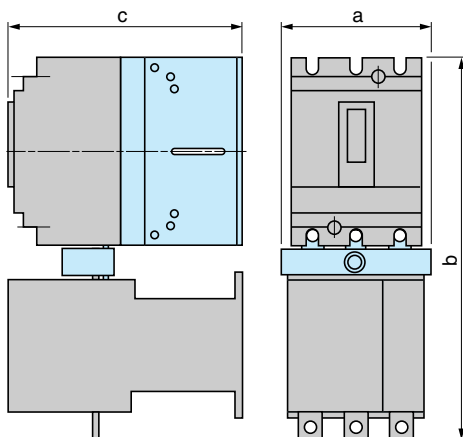

	a	b	c
GV7 R + LC1 F115 or F150 + GV7 AC06	119	334	181
GV7 R + LC1 F185 + GV7 AC06	119	338	188
GV7 R + LC1 F225 + GV7 AC07	131	358	188
GV7 R + LC1 F265 + GV7 AC07	131	364	215

Minimum distance between 2 circuit-breakers mounted side by side = 0

#### Minimum electrical clearance

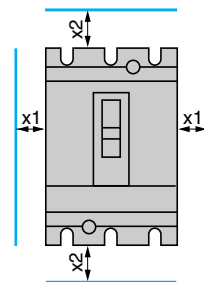

	x1	x2
Painted or insulated metal plate, insulation or insulated bar	0	30
Bare metal plate	U ≤ 440 V	5
	440 V < U < 600 V	10
	U ≥ 600 V	20

#### GV7 R

Panel mounting

Mounting on 2 mounting rails DZ5 MB201

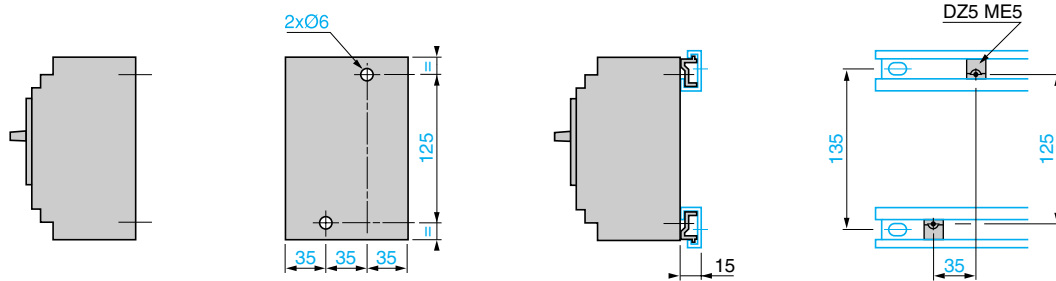

#### Flush-mounting

1 circuit-breaker GV7 R

n circuit-breakers GV7 R  
side by side

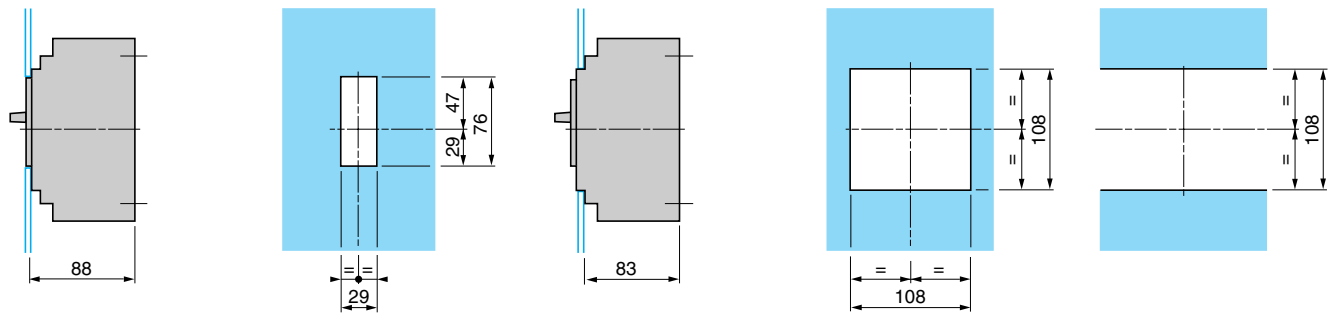

#### Combination of GV7 R and contactor LC1 F with kit GV7 AC0●

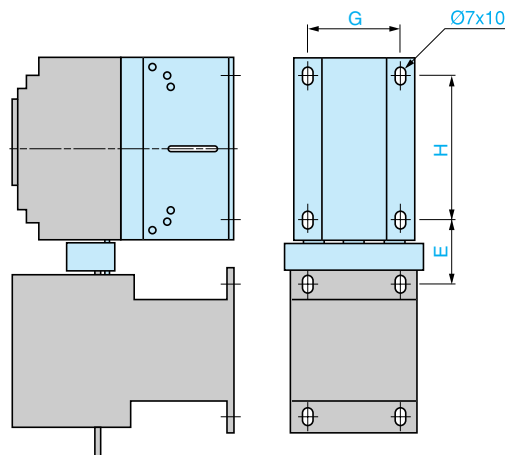

	E	G	H
GV7 R + LC1 F115 + GV7 AC06	44	85	120
GV7 R + LC1 F150 + GV7 AC06	46	85	120
GV7 R + LC1 F185 + GV7 AC06	48	85	120
GV7 R + LC1 F225 + GV7 AC07	57	85	120
GV7 R + LC1 F265 + GV7 AC07	60	85	120



#### GV7 R

##### Spreaders GV7 AC03

##### Connection

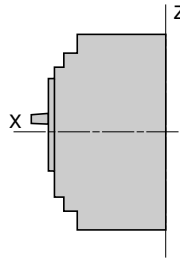
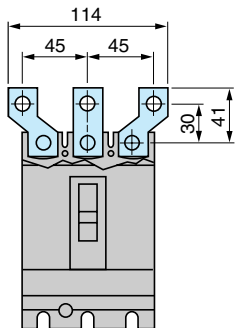

##### Smooth terminals

##### Connectors

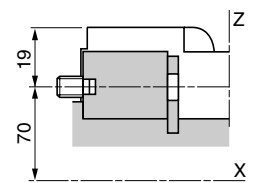
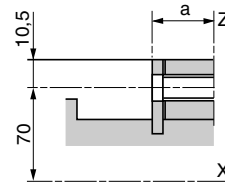

	a
GV7 R●40...R●150	19.5
GV7 R●220	21.5

##### Direct rotary handle GV7 AP03, GV7 AP04

##### Flush-mounting

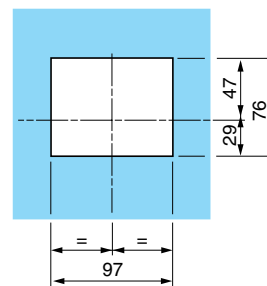
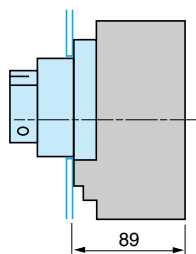
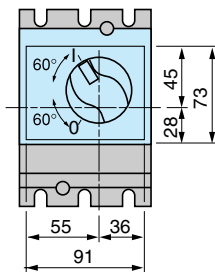
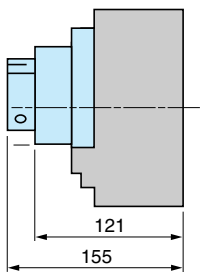

##### Direct rotary handle GV7 AP03 or GV7 AP04 with conversion accessory GV7 AP05

##### Front face cut-out

##### Enclosure viewed from top

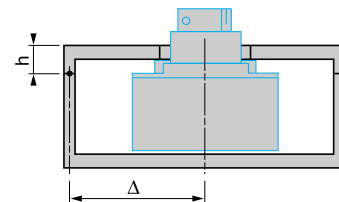
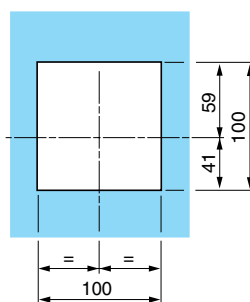
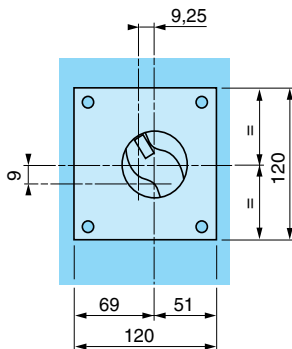
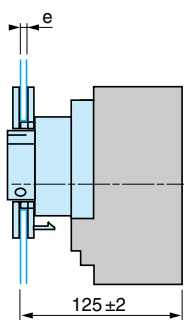

Door cut-outs require a minimum distance between the centre of the circuit-breaker and the door hinge point  $\Delta \geq 100 + (h \times 5)$ .

e = 1 to 3 max

##### Extended rotary handle GV7 AP01, GV7 AP02

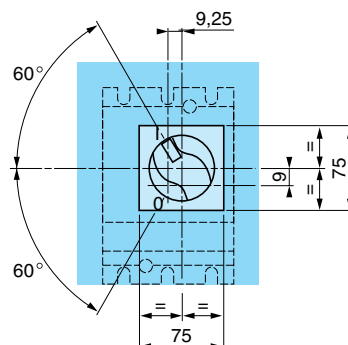
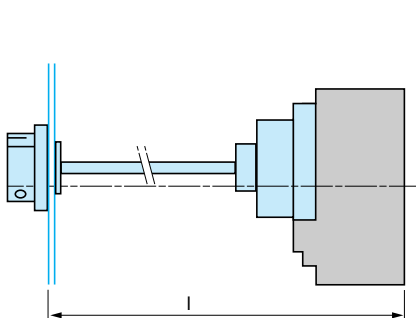

l: 185 min, 600 max

The shaft of the extended rotary handle GV7 AP01 or GV7 AP022 must be cut to length: l – 126 mm.

## Schemes

### GV2 ME●● and GV2 RT

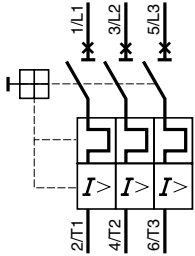

### GV2 P●●

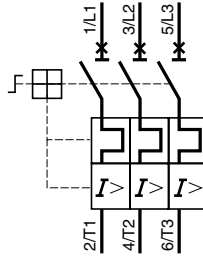

### GV3 P●●

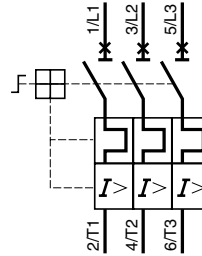

### Front mounting add-on contact blocks Instantaneous auxiliary contacts

#### GV AE1      GV AE11      GV AE20

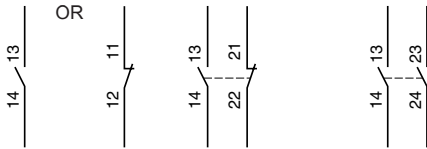

### Front mounting add-on contact blocks Instantaneous auxiliary contacts and fault signalling contacts

#### GV AED101      GV AED011



### Side mounting add-on contact blocks Instantaneous auxiliary contacts and fault signalling contacts

#### GV AD0110      GV AD0101      GV AD1010      GV AD1001



### Instantaneous auxiliary contacts

#### GV AN11      GV AN20



### Short-circuit signalling contacts

#### GV AM11

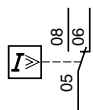

### Voltage trips

#### GV AU●●●      GV AS●●●      GV AX●●●

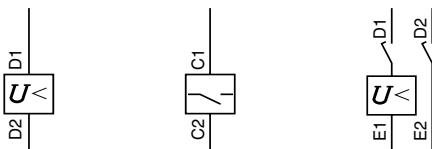

### Current limiter

#### GV1 L3

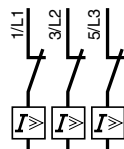

### Use of fault signalling contact and short-circuit signalling contact

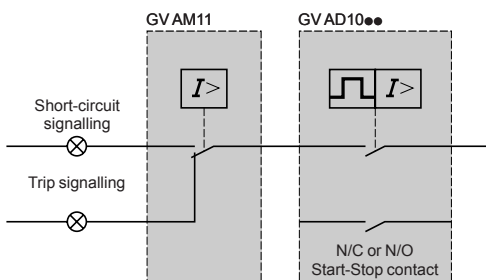

### Connection of undervoltage trip for dangerous machines (conforming to INRS) on GV2 ME only

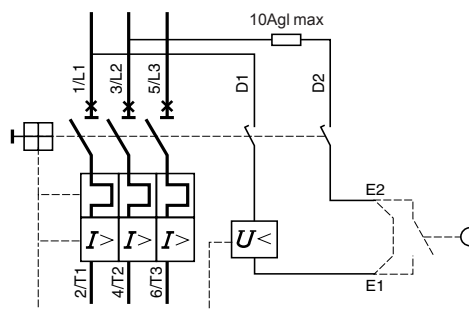

#### Schemes

##### Motor circuit-breakers

GV3 ME80

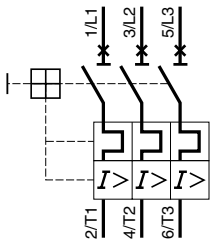

##### Auxiliary contact block modules

GV3 A01

GV3 A02

GV3 A03

GV3 A05

GV3 A06

GV3 A07

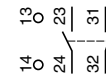
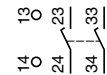
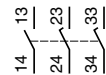
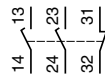

##### Fault signalling contacts

GV3 A08

GV3 A09

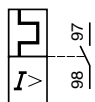
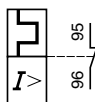

##### Voltage trips

GV3 B

GV3 D



##### Motor circuit-breakers

GV7 R

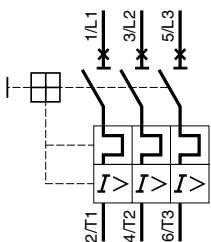

##### Add-on auxiliary contacts according to their location (1)

GV7 AE11, GV7 AB11

Location 1  
C/O contact

Location 2  
Trip indication

Location 3  
Electrical fault  
indication

Location 4  
C/O contact



A self-adhesive label, supplied with the contact, can be affixed to the front face of the circuit-breaker to allow personalised marking according to the function of the contact or contacts.  
(1) See pages 48 and 87.

##### Electric trips

GV7 AU●●●

GV7 AS●●●

GV7 AD111, AD112

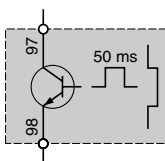
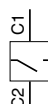
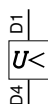

##### Recommended application schemes GV7 AD111, AD112

###### Fault indication

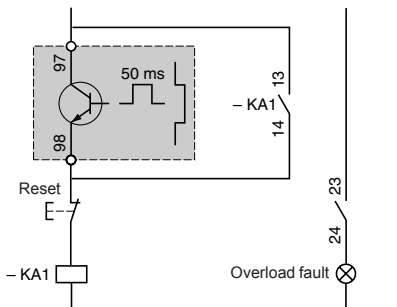

###### Contacting opening on overload

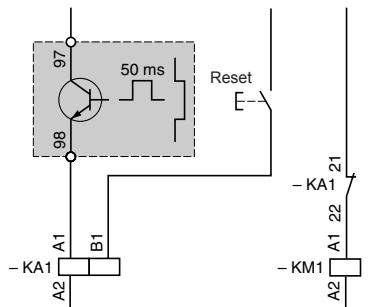

Associated components  
KA1: CA2 KN or CAD N

Associated components  
KA1: CAD + LAD 6K10 or RHK  
KM1: LC1 D or LC1 F

#### GV2 L

##### Dimensions

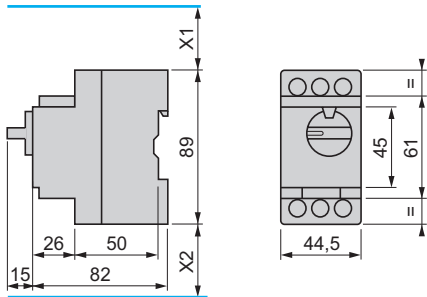

##### GV AD, AM, AN, AU, AS

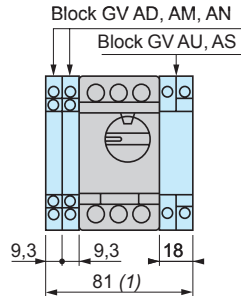

##### GV2 AK00

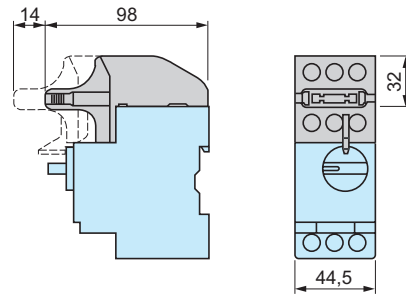

X1 Electrical clearance = 40 mm for  $U_e \leq 415$  V, or 80 mm for  $U_e = 440$  V, or 120 mm for  $U_e = 500$  and 690 V.  
X2 = 40 mm.

(1) Maximum

##### Mounting

On rail AM1 DE200,  
AM1 ED200 (35 x 15)

Panel mounted

On pre-slotted mounting  
plate AM1 PA

##### Adapter plate GK2 AF01

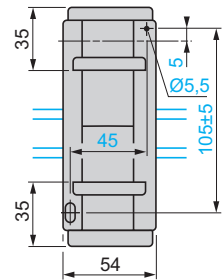
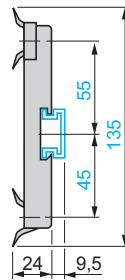
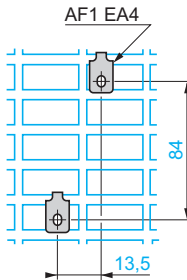
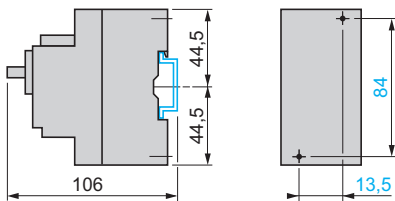

##### 7.5 mm height compensation plate GV1 F03



#### GV2 LE

##### Dimensions

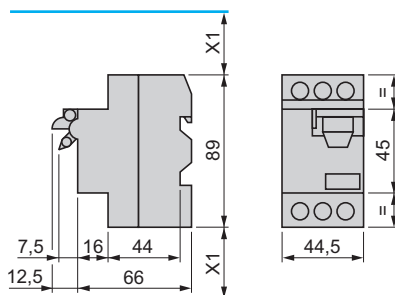

##### GV AD, AM, AN, AU, AS

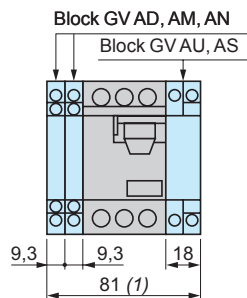

##### GV AE

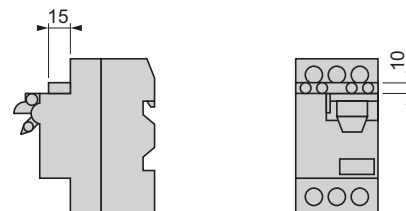

X1 Electrical clearance = 40 mm for  $U_e \leq 690$  V.

(1) Maximum

##### Mounting

On 35 mm rail

On panel with adapter plate GV2 AF02

On pre-slotted plate AM1 PA

On rails DZ5 MB201

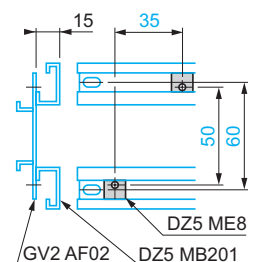
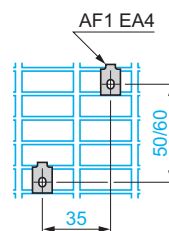
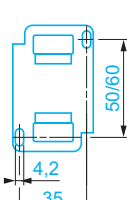
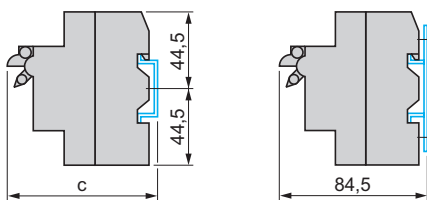

c = 80 on AM1 DP200  
(35 x 7.5) and 88 on  
AM1 DE200, ED200 (35 x 15)